

Barrage U16 F -57VBM

1. FONTAINE Megghann, Kime-Waza (Bleu)

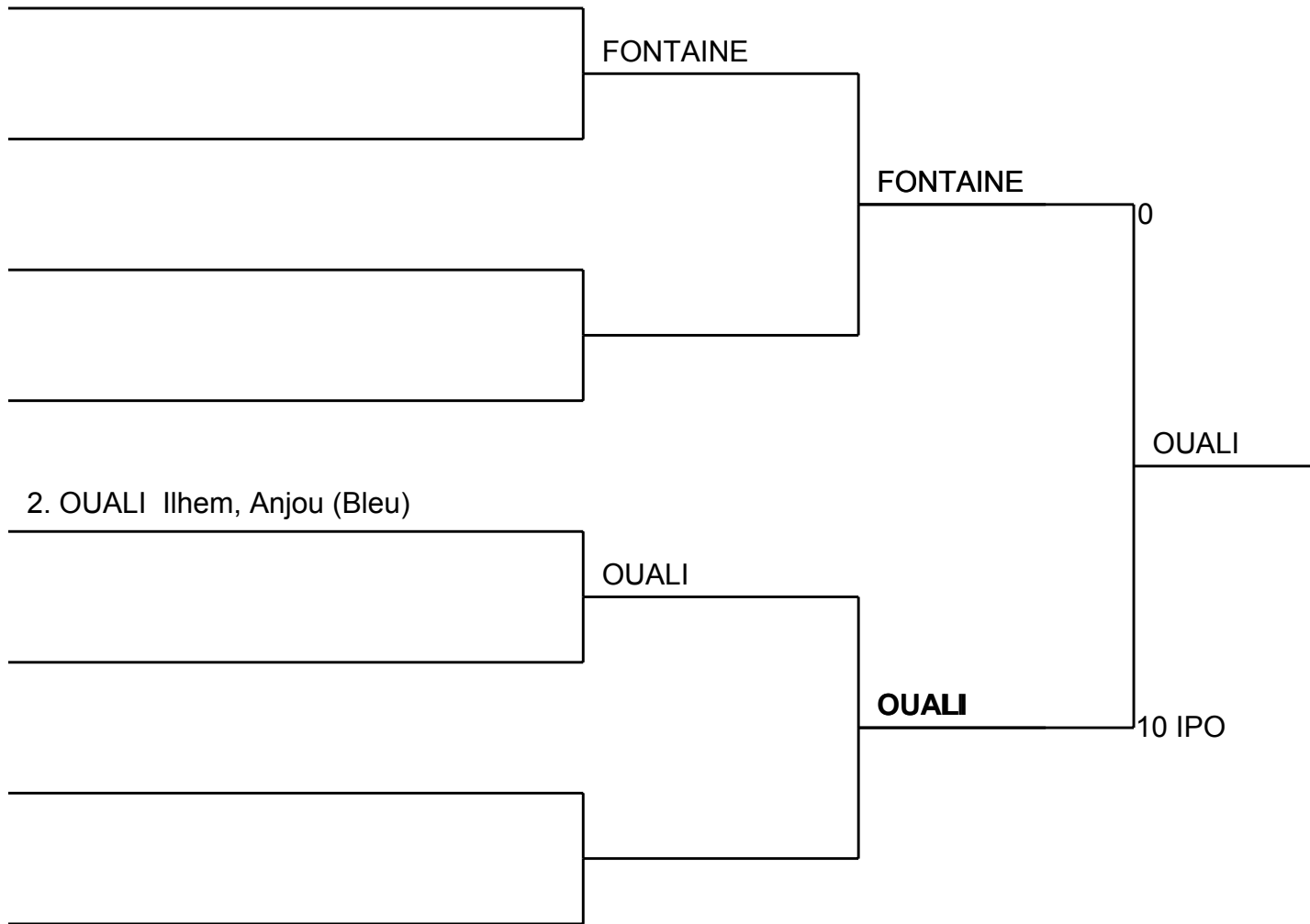

Results/Résultats

Pos	Name/Nom
1	OUALI Ilhem, Anjou
2	FONTAINE Megghann, Kime-Waza
3	
3	

Barrage U16 F -63VBM

1. HUOT-TREMBLAY Katherine, Charlesbourg (Bleu)

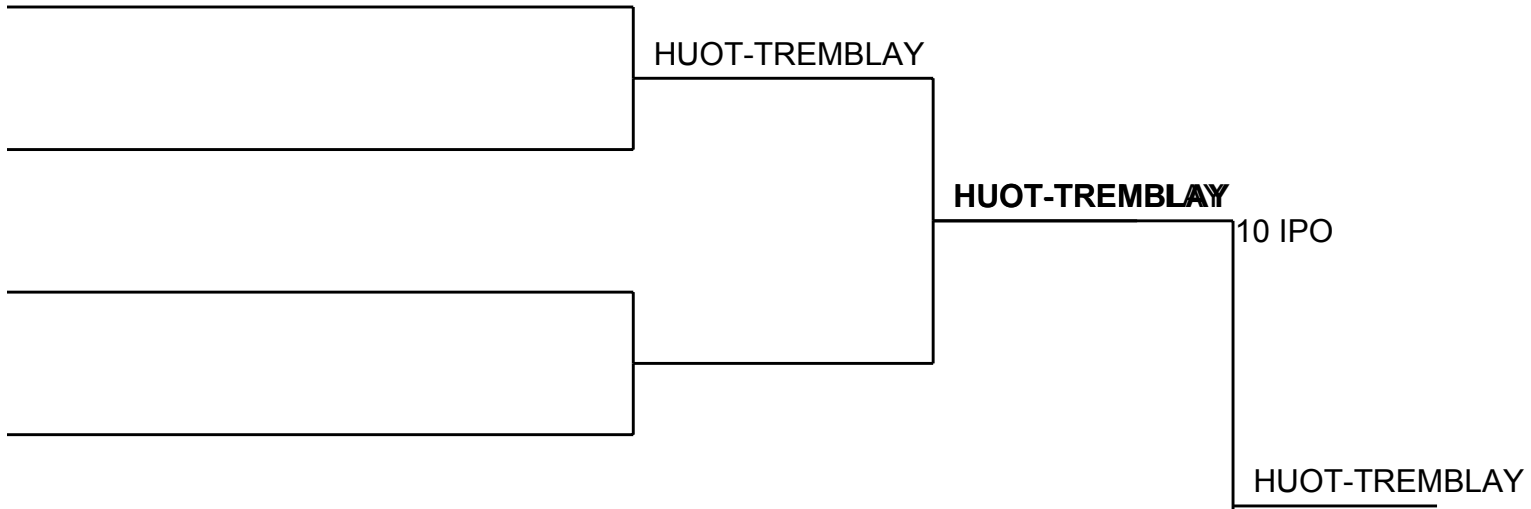

2. LÉVESQUE Justine, Judo-Tech (Bleu)



Results/Résultats

Pos	Name/Nom
1	HUOT-TREMBLAY Katherine, Charlesbourg
2	LÉVESQUE Justine, Judo-Tech
3	
3	

Barrage U16 M -50VBM

1. TARDIF Anthony, To-hakukan (Bleu)

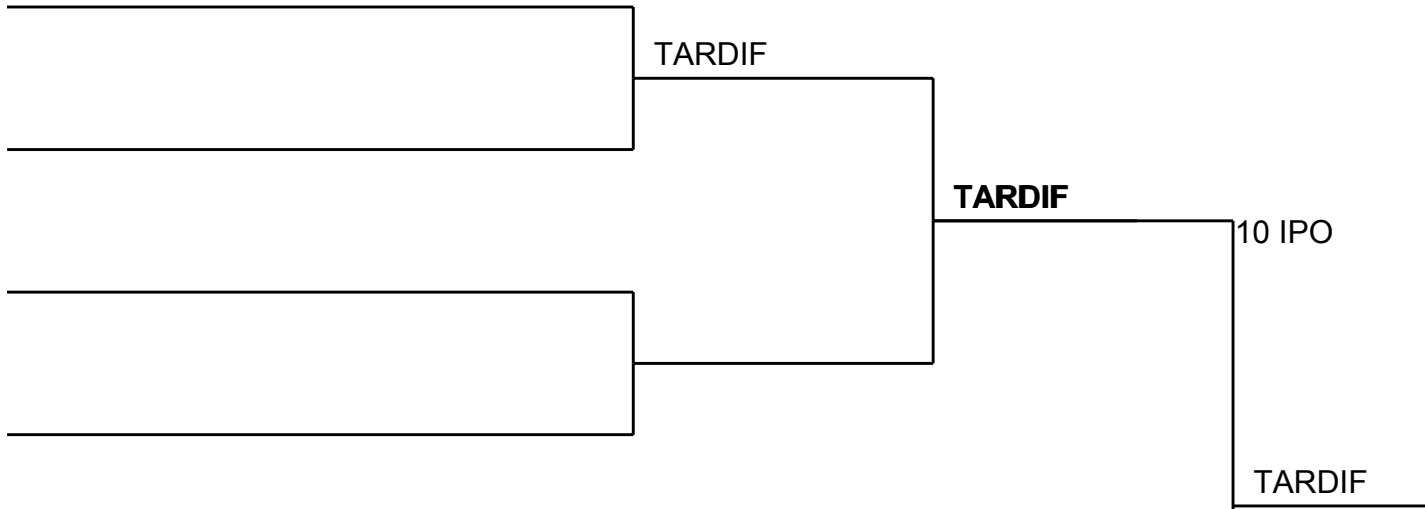

2. LEMIEUX Jason, Lévis (Vert/Bleu)

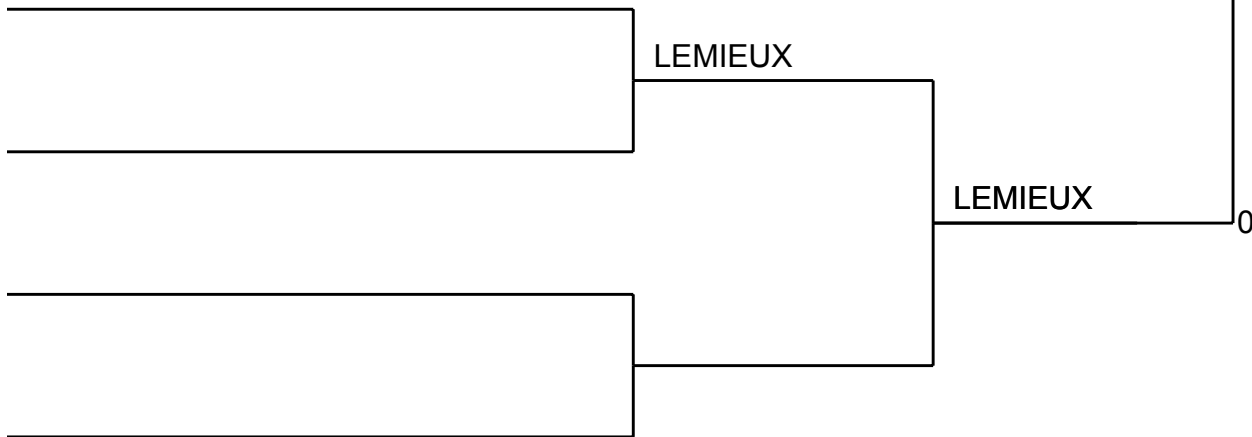

Results/Résultats

Pos	Name/Nom
1	TARDIF Anthony, To-hakukan
2	LEMIEUX Jason, Lévis
3	
3	

Barrage U16 M -55VBM

1. GÉLINAS Maxime, Olympique (Marron)

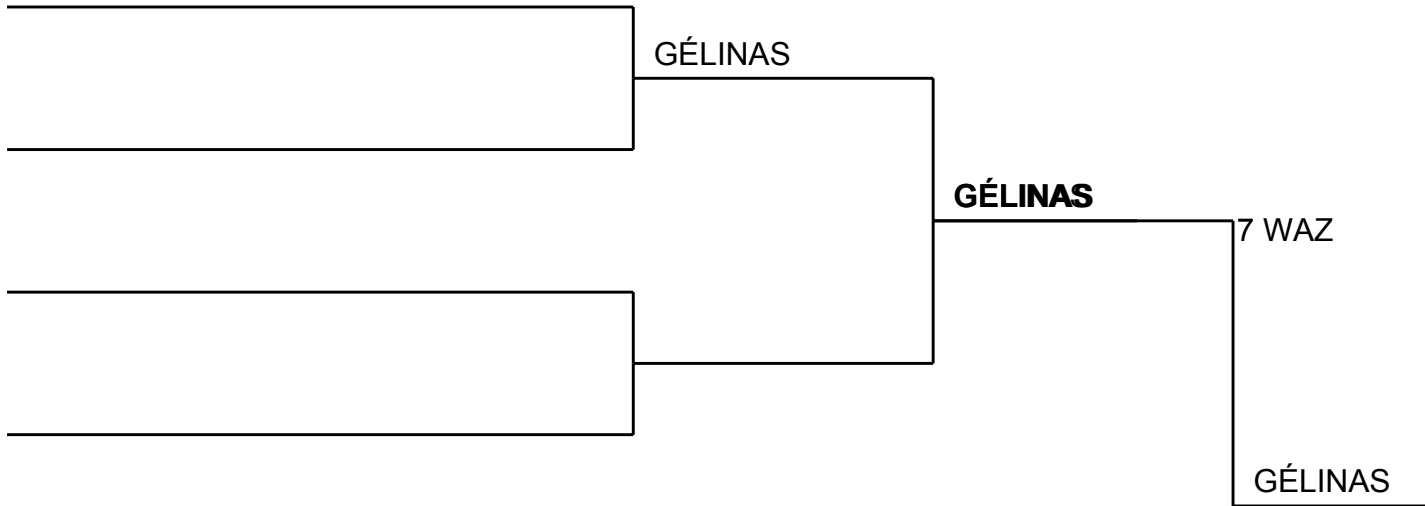

2. TREMBLAY Jean-David, J.Jonquiere (Marron)

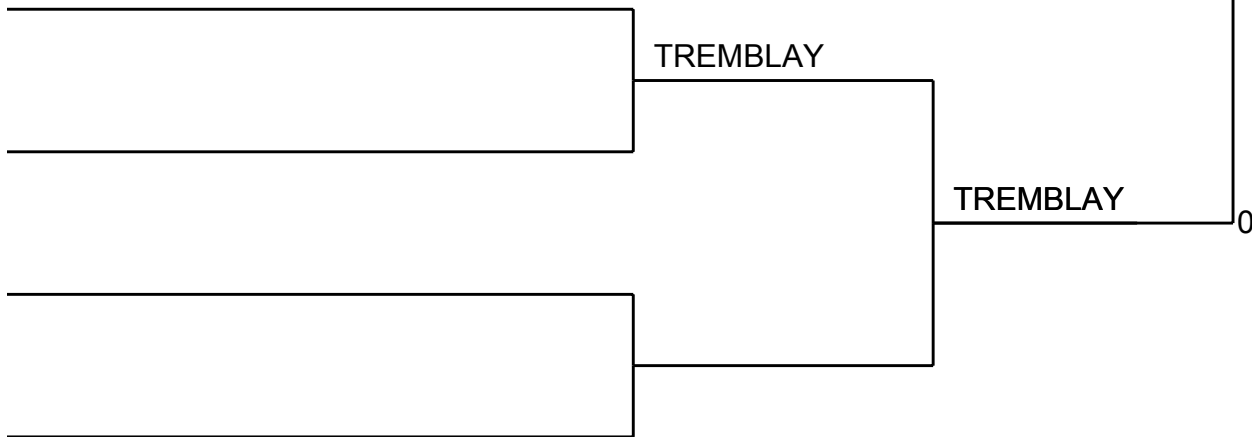

Results/Résultats

Pos	Name/Nom
1	GÉLINAS Maxime, Olympique
2	TREMBLAY Jean-David, J.Jonquiere
3	
3	

Barrage U16 M -60VBM

1. DIAZ Roland, Métropolitain (Marron)

DIAZ



DIAZ

0

2. PENCHEV Martin, Métropolitain (Marron)

PENCHEV



PENCHEV

5 YUK

PENCHEV



Results/Résultats

Pos	Name/Nom
1	PENCHEV Martin, Métropolitain
2	DIAZ Roland, Métropolitain
3	
3	

Barrage U16 M -66VBM

1. JEAN-PIERRE Leewis, PAT (Marron)

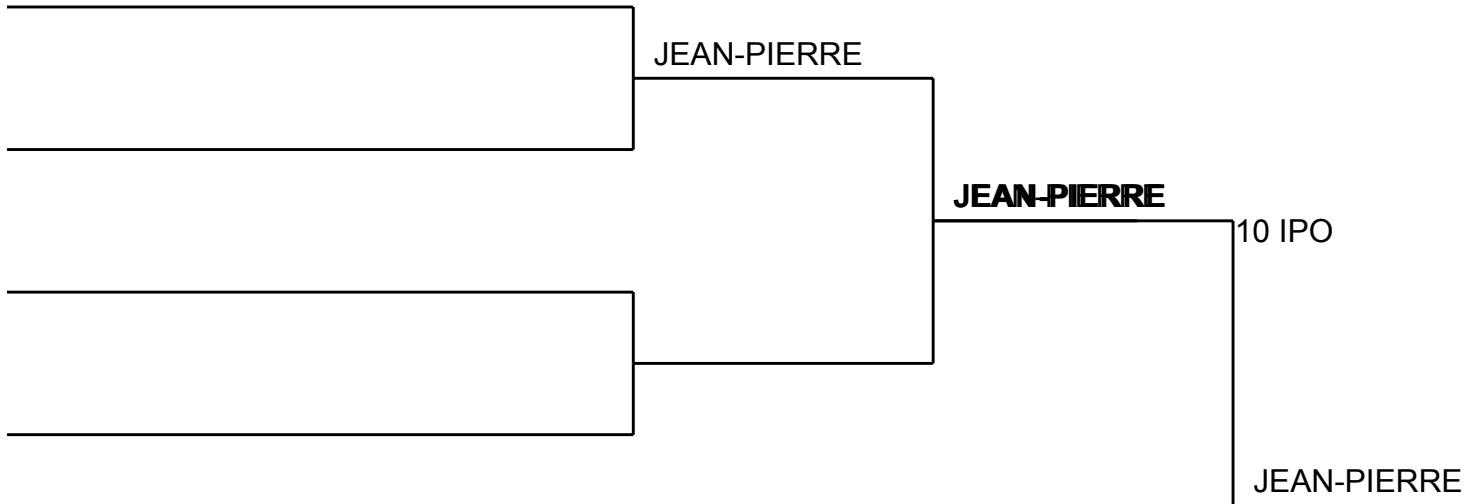

2. SAVARD Olivier, JU SHIN KAN (Bleu/Marron)

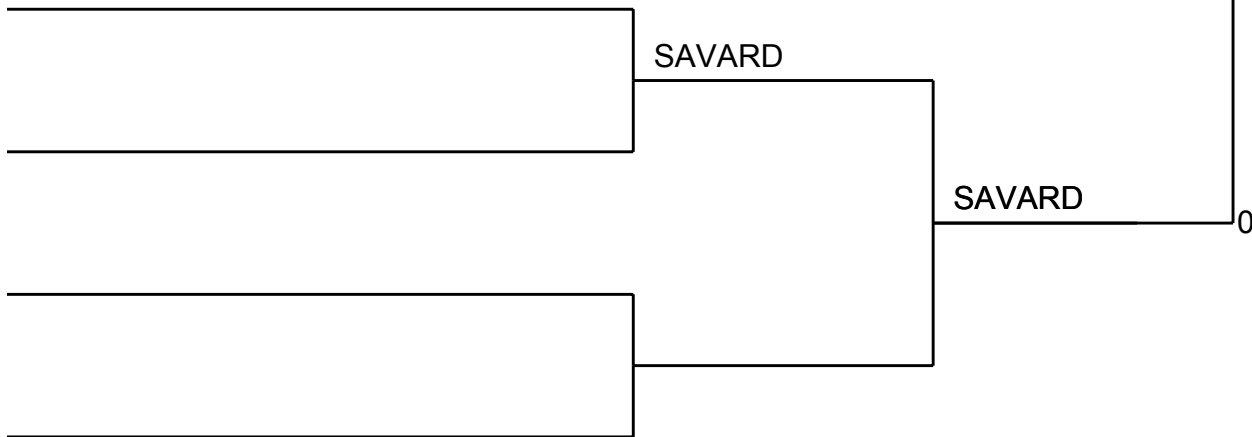

Results/Résultats

Pos	Name/Nom
1	JEAN-PIERRE Leewis, PAT
2	SAVARD Olivier, JU SHIN KAN
3	
3	

Barrage U16 M -73VBM

1. MARTINEAU Tom, Chicoutimi (Bleu)

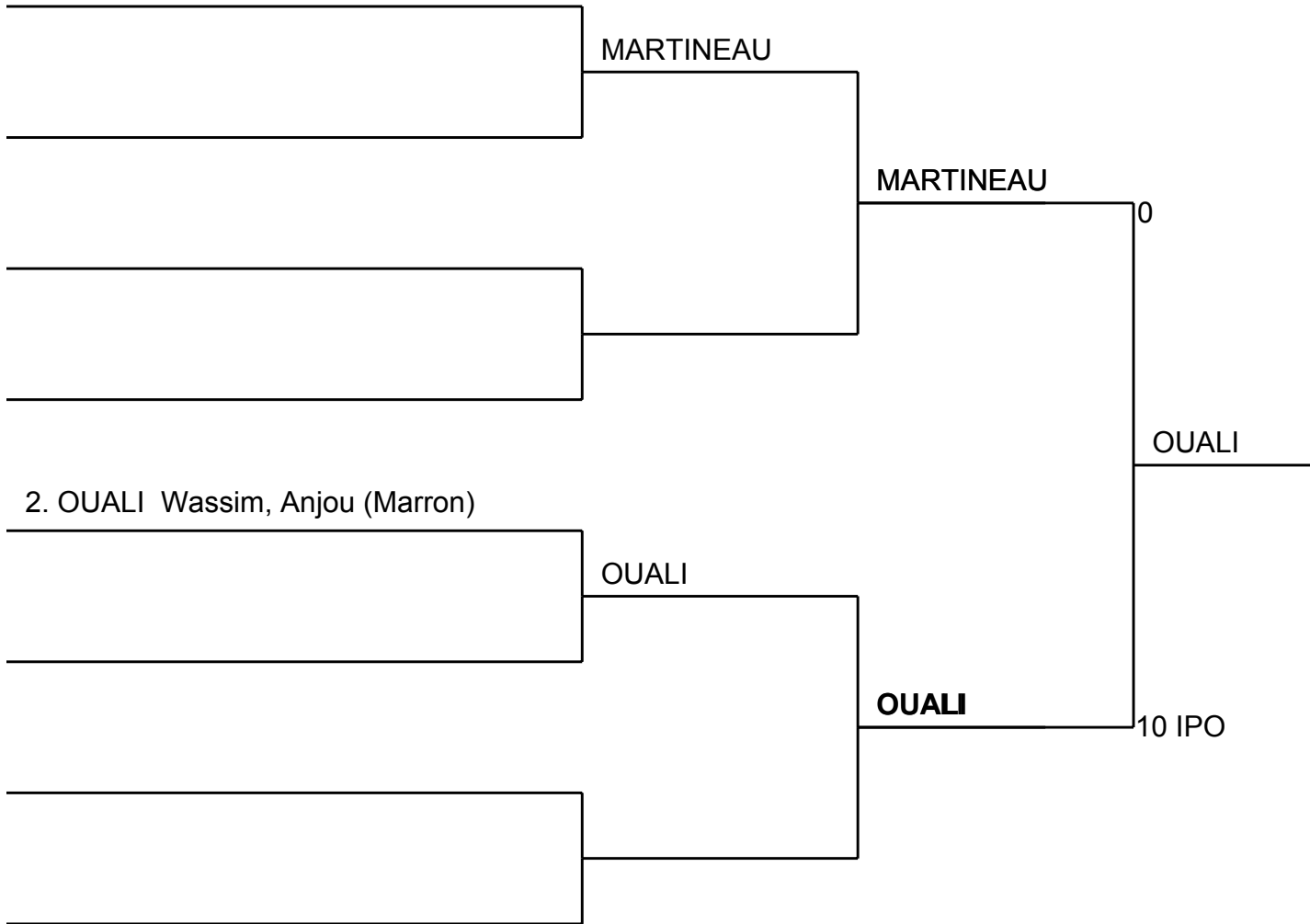

Results/Résultats

Pos	Name/Nom
1	OUALI Wassim, Anjou
2	MARTINEAU Tom, Chicoutimi
3	
3	

Tie-BreakerU16M-66JO

Competitors/Compétiteurs

#	Name/Nom	Grade	Club	1	2	3	W/G	Pts	Pos
1	CROITORU Artur	Orange	Anjou				0	0	3
2	HOUNGBEDJI Loïc	Jaune	St-Paul l'Ermite	10			1	10	2
3	BEAUDOIN Migaël	Orange	Métropolitain	10	1		2	11	1

Matches/Matches

Match	White/Blanc			Blue/Bleu	Res/Rés	Tim/Tmp	Code
F-1	CROITORU Artur	1	2	HOUNGBEDJI Loïc	0 - 10	1:19	GSI
F-2	CROITORU Artur	1	3	BEAUDOIN Migaël	0 - 10	3:30	GSI
F-3	HOUNGBEDJI Loïc	2	3	BEAUDOIN Migaël	0 - 1	1:25	GSD

Results/Résultats

Pos	Name/Nom
1	BEAUDOIN Migaël, Métropolitain
2	HOUNGBEDJI Loïc, St-Paul l'Ermite

U16F +70VBM

Competitors/Compétiteurs

#	Name/Nom	Grade	Club	1	2	3	4	W/G	Pts	Pos
1	SYNOTT Josianne	Vert	Sept-iles			10	10	2	20	2
2	GIGUERE LETOURNEAU Lea Lou	Bleu	SEIKIDOKAN	10		10	10	3	30	1
3	WAHBA maram	Bleu	Anjou				10	1	10	3
4	ARCHAMBAULT Audrey	Vert	Asbestos					0	0	4

Matches/Matches

Match	White/Blanc			Blue/Bleu	Res/Rés	Tim/Tmp	Code
C-14	SYNOTT Josianne	1	2	GIGUERE LETOURNEAU Lea Lou	0 - 10	0:42	WIP
C-15	WAHBA maram	3	4	ARCHAMBAULT Audrey	10 - 0	1:15	IPO
C-27	SYNOTT Josianne	1	3	WAHBA maram	10 - 0	2:23	IPO
C-28	GIGUERE LETOURNEAU Lea Lou	2	4	ARCHAMBAULT Audrey	10 - 0	0:19	WIP
C-39	SYNOTT Josianne	1	4	ARCHAMBAULT Audrey	10 - 0	0:41	IPO
C-40	GIGUERE LETOURNEAU Lea Lou	2	3	WAHBA maram	10 - 0	0:00	FUS

Results/Résultats

Pos	Name/Nom
1	GIGUERE LETOURNEAU Lea Lou, SEIKIDOKAN
2	SYNOTT Josianne, Sept-iles
3	WAHBA maram, Anjou

U16F -40VBM

Competitors/Compétiteurs

#	Name/Nom	Grade	Club	1	W/G	Pts	Pos
1	SOMERS Andrée-Ann	Bleu	Sept-iles		0	0	1

Matches/Matches

Match	White/Blanc	Blue/Bleu	Res/Rés	Tim/Tmp	Code
-------	-------------	-----------	---------	---------	------

Results/Résultats

Pos	Name/Nom

U16F -44VBM

Competitors/Compétiteurs

#	Name/Nom	Grade	Club	1	2	3	W/G	Pts	Pos
1	BOUSBIAT Amira	Vert	Boucherville			10	1	10	2
2	ROY Léa	Vert/Bleu	Asbestos	5		10	2	15	1
3	SOMERS Andrée-Ann	Bleu	Sept-iles				0	0	3

Matches/Matches

Match	White/Blanc			Blue/Bleu	Res/Rés	Tim/Tmp	Code
B-15	BOUSBIAT Amira	1	2	ROY Léa	0 - 5	3:00	YUK
B-31	BOUSBIAT Amira	1	3	SOMERS Andrée-Ann	10 - 0	0:49	IPO
B-39	ROY Léa	2	3	SOMERS Andrée-Ann	10 - 0	1:36	WIP

Results/Résultats

Pos	Name/Nom
1	ROY Léa, Asbestos
2	BOUSBIAT Amira, Boucherville

U16F -48VBM

Competitors/Compétiteurs

#	Name/Nom	Grade	Club	1	2	3	W/G	Pts	Pos
1	LAVIGNE BONNEAU Tamy-Lee	Vert	Rikidokan				0	0	3
2	SCREMIN Sabrina	Marron	Sept-iles	7			1	7	2
3	COSSETTE Alicia	Marron	SEIKIDOKAN	10	10		2	20	1

Matches/Matches

Match	White/Blanc			Blue/Bleu	Res/Rés	Tim/Tmp	Code
D-8	LAVIGNE BONNEAU Tamy-Lee	1	2	SCREMIN Sabrina	0 - 7	4:13	GSW
D-20	LAVIGNE BONNEAU Tamy-Lee	1	3	COSSETTE Alicia	0 - 10	1:17	WIP
D-32	SCREMIN Sabrina	2	3	COSSETTE Alicia	0 - 10	0:35	IPO

Results/Résultats

Pos	Name/Nom
1	COSSETTE Alicia, SEIKIDOKAN
2	SCREMIN Sabrina, Sept-iles

U16F -52VBM

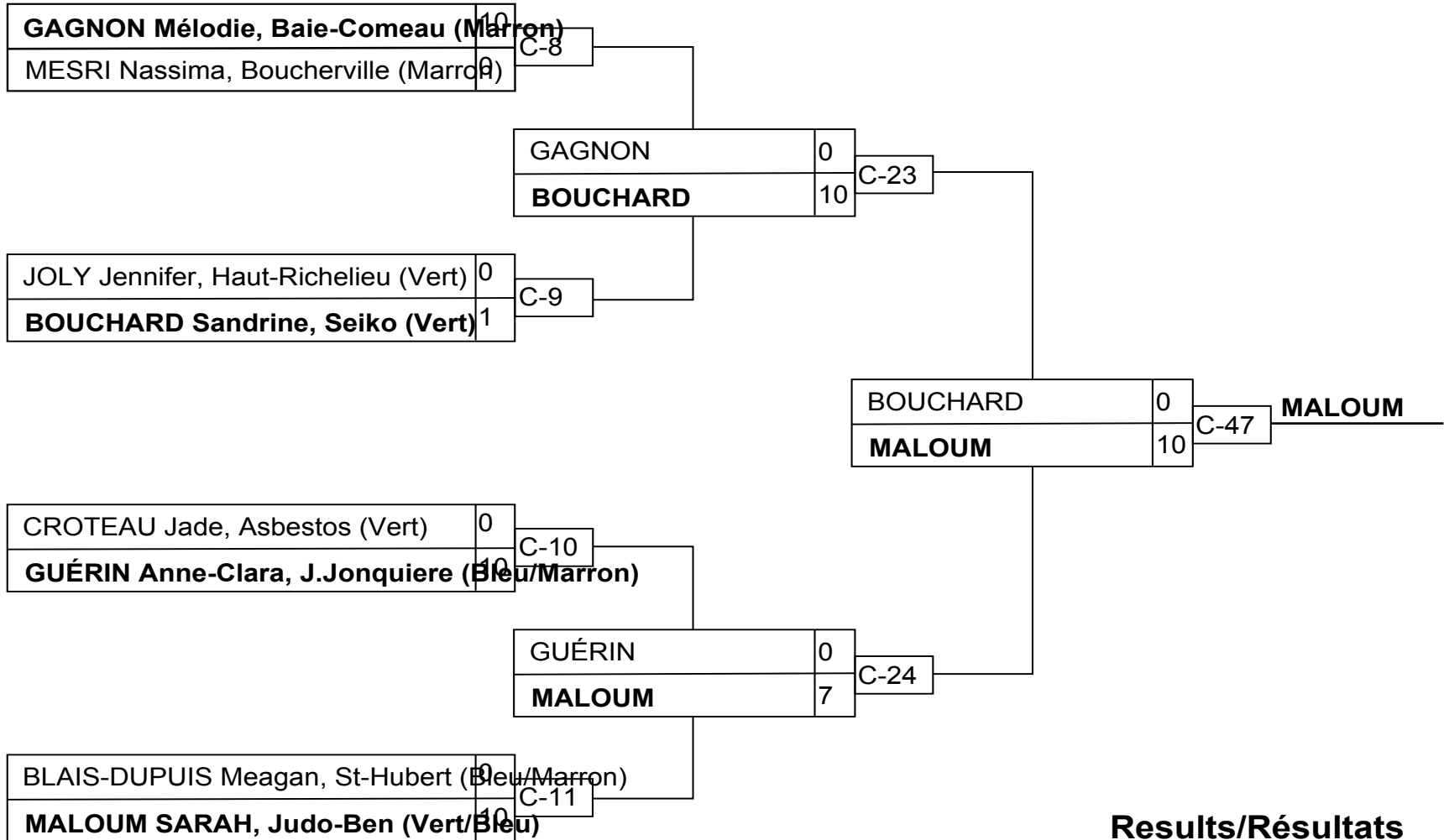

Results/Résultats

Pos	Name/Nom
1	MALOUM SARAH, Judo-Ben (Vert/Bleu)
2	BOUCHARD Sandrine, Seiko (Vert)
3	GAGNON Mélodie, Baie-Comeau (Marron)
3	MESRI Nassima, Boucherville (Marron)

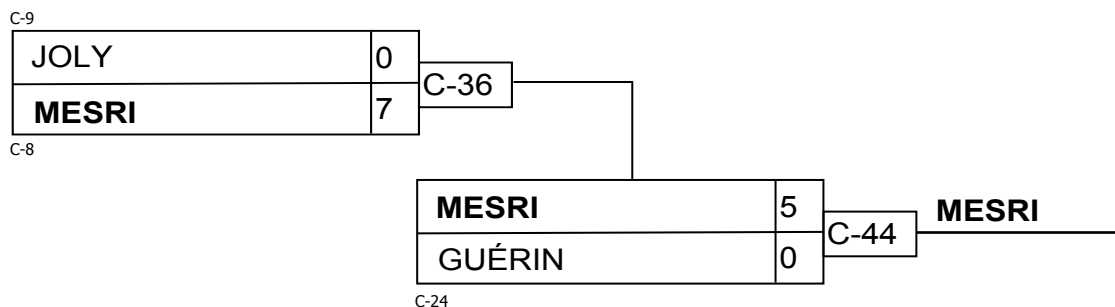
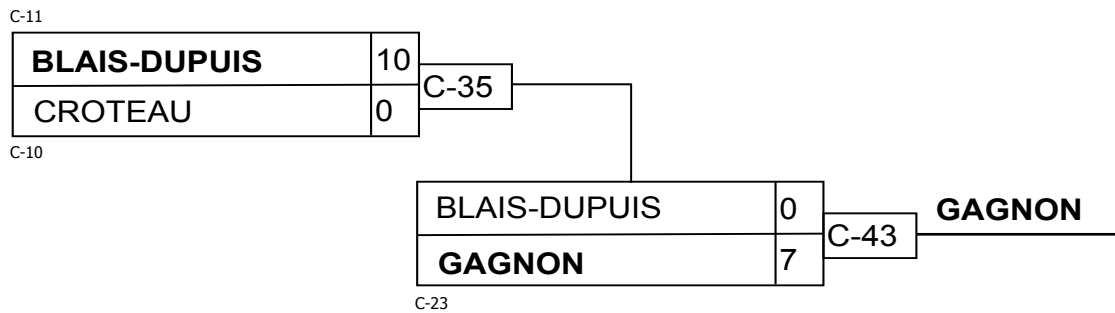

U16F -57VBM

Competitors/Compétiteurs A

#	Name/Nom	Grade	Club	1	2	3	4	W/G	Pts	Pos
1	DUMOULIN Catherine	Bleu	To-hakukan					0	0	4
2	OUALI Ilhem	Bleu	Anjou	10			5	2	15	2
3	BOUSSARHANE Samia	Vert	Boucherville	1	1			2	2	3
4	EMOND Roxanne	Bleu/Marron	JU SHIN KAN	10		10		2	20	1

Matches/Matches A

Match	White/Blanc	Blue/Bleu	Res/Rés	Tim/Tmp	Code
D-5	DUMOULIN Catherine 1 2	OUALI Ilhem	0 - 10	1:40	IPO
D-6	BOUSSARHANE Samia 3 4	EMOND Roxanne	0 - 10	2:20	IPO
D-17	DUMOULIN Catherine 1 3	BOUSSARHANE Samia	0 - 1	3:00	YUS
D-18	OUALI Ilhem 2 4	EMOND Roxanne	5 - 0	3:00	YUK
D-29	DUMOULIN Catherine 1 4	EMOND Roxanne	0 - 10	0:54	IPO
D-30	OUALI Ilhem 2 3	BOUSSARHANE Samia	0 - 1	3:00	YUS

Competitors/Compétiteurs B

#	Name/Nom	Grade	Club	5	6	7	W/G	Pts	Pos
5	FONTAINE Megghann	Bleu	Kime-Waza			10	1	10	2
6	DOUHAUD Johanna	Marron	Blainville	10		10	2	20	1
7	ADAMS Megan	Vert	Judo-Tech				0	0	3

Matches/Matches B

Match	White/Blanc	Blue/Bleu	Res/Rés	Tim/Tmp	Code
D-7	FONTAINE Megghann 5 6	DOUHAUD Johanna	0 - 10	0:07	IPO
D-19	FONTAINE Megghann 5 7	ADAMS Megan	10 - 0	1:31	IPO
D-31	DOUHAUD Johanna 6 7	ADAMS Megan	10 - 0	1:38	IPO

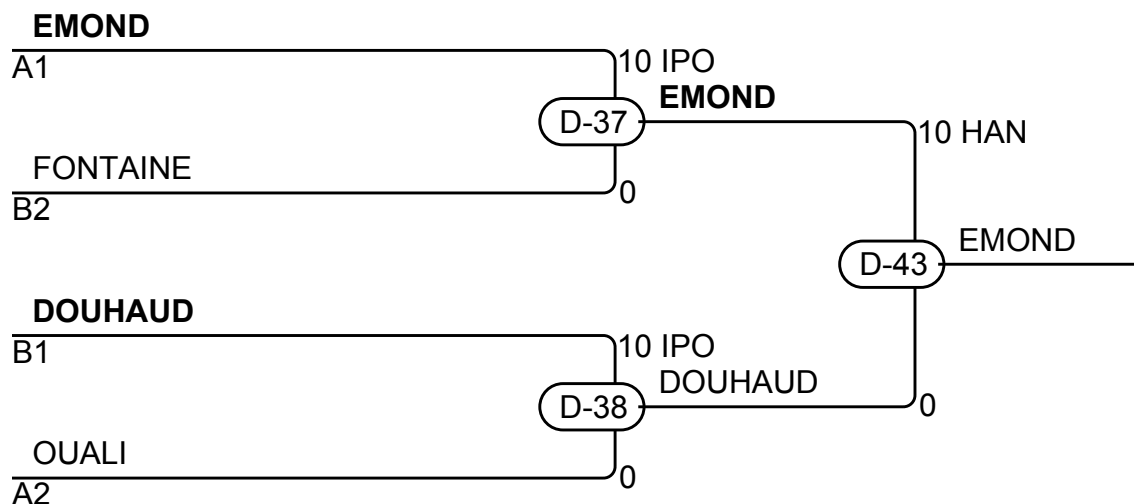

Results/Résultats

Pos	Name/Nom
1	EMOND Roxanne, JU SHIN KAN
2	DOUHAUD Johanna, Blainville
3	FONTAINE Megghann, Kime-Waza
3	OUALI Ilhem, Anjou

U16F -63VBM

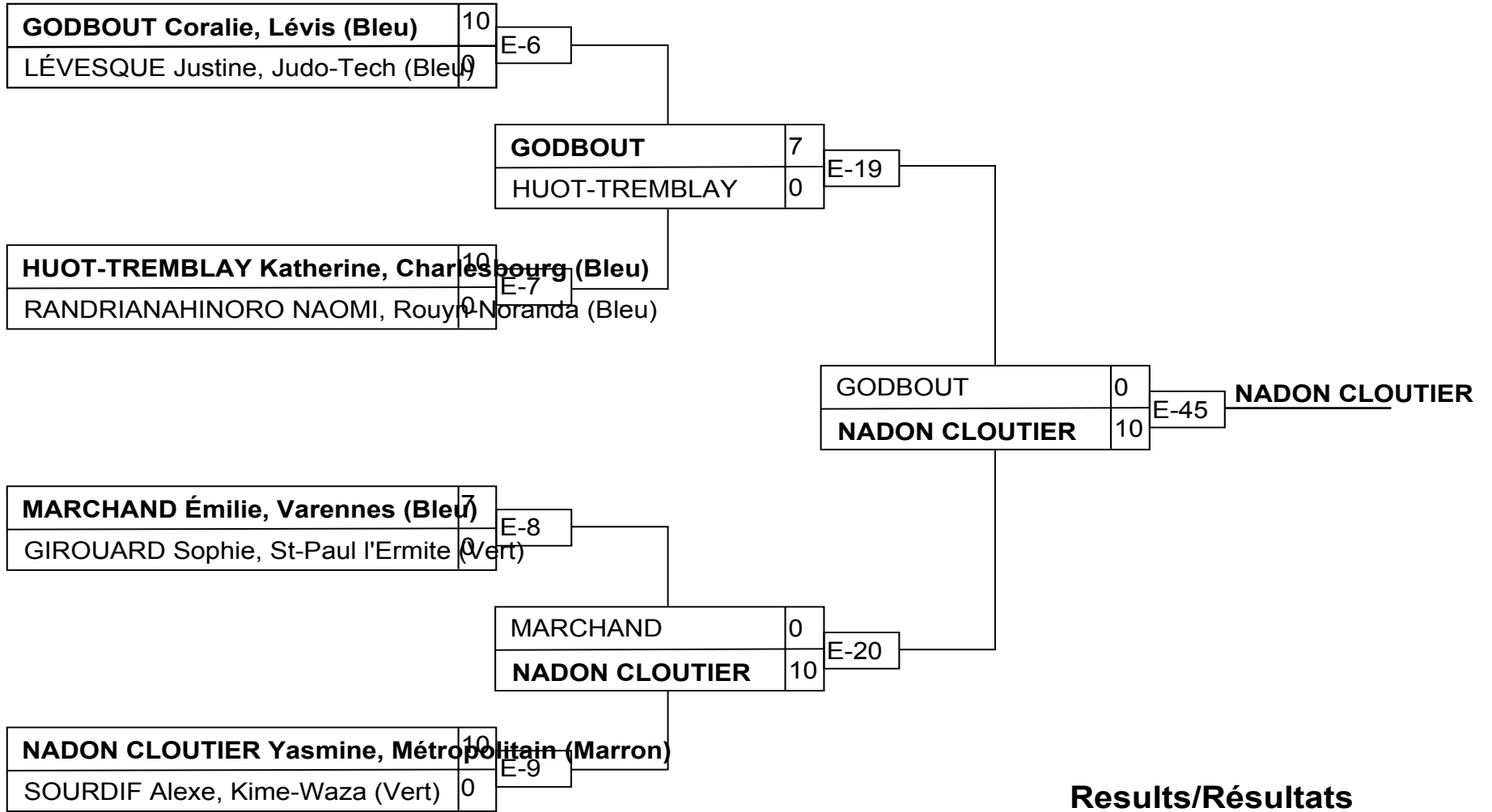

Results/Résultats

Pos	Name/Nom
1	NADON CLOUTIER Yasmine, Métropolitain (Marron)
2	GODBOUT Coralie, Lévis (Bleu)
3	HUOT-TREMBLAY Katherine, Charlesbourg (Bleu)
3	LÉVESQUE Justine, Judo-Tech (Bleu)

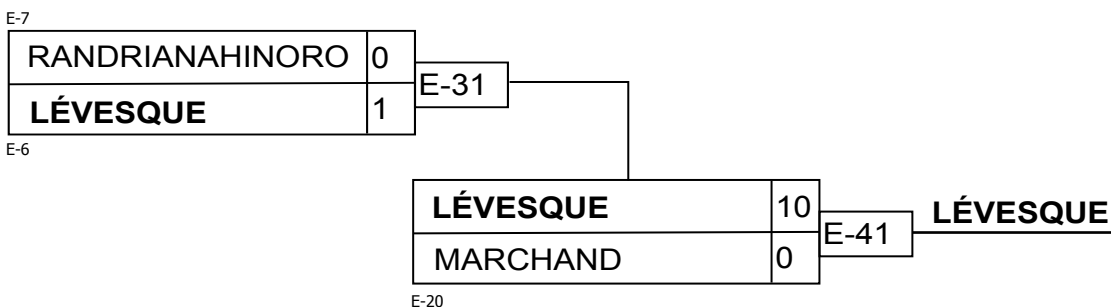
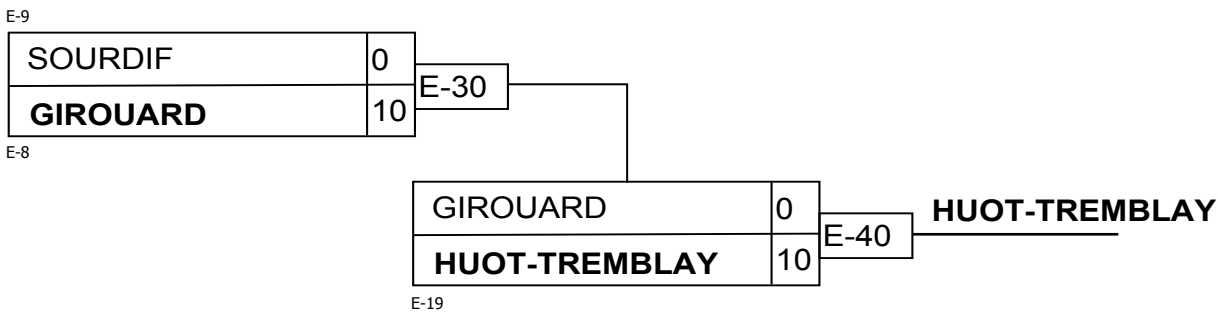

U16F -70VBM

Competitors/Compétiteurs

#	Name/Nom	Grade	Club	1	W/G	Pts	Pos
1	GIGUERE LETOURNEAU Lea Lou	Bleu	SEIKIDOKAN		0	0	1

Matches/Matches

Match	White/Blanc	Blue/Bleu	Res/Rés	Tim/Tmp	Code
-------	-------------	-----------	---------	---------	------

Results/Résultats

Pos	Name/Nom

U16F -36JO

Competitors/Compétiteurs

#	Name/Nom	Grade	Club	1	2	1	2	1	2	W/G	Pts	Pos
1	BRIARD Matilde	Jaune	Haut-Richelieu							0	0	2
2	GAGNÉ Amélie	Jaune/Orange	Boucherville	10		10				2	20	1

Matches/Matches

Match	White/Blanc			Blue/Bleu	Res/Rés	Tim/Tmp	Code
E-10	BRIARD Matilde	1	2	GAGNÉ Amélie	0 - 10	0:31	IPO
E-21	BRIARD Matilde	1	2	GAGNÉ Amélie	0 - 10	0:11	IPO
E-32	BRIARD Matilde	1	2	GAGNÉ Amélie			

Results/Résultats

Pos	Name/Nom
1	GAGNÉ Amélie, Boucherville

U16F -52JO

Competitors/Compétiteurs

#	Name/Nom	Grade	Club	1	2	1	2	1	2	W/G	Pts	Pos
1	CLOUTIER Melyssa	Orange	SEIKIDOKAN							0	0	2
2	BENGATTAF Soraya	Orange	Anjou	10		10				2	20	1

Matches/Matches

Match	White/Blanc			Blue/Bleu	Res/Rés	Tim/Tmp	Code
E-12	CLOUTIER Melyssa	1	2	BENGATTAF Soraya	0 - 10	0:56	WIP
E-23	CLOUTIER Melyssa	1	2	BENGATTAF Soraya	0 - 10	0:39	IPO
E-34	CLOUTIER Melyssa	1	2	BENGATTAF Soraya			

Results/Résultats

Pos	Name/Nom
1	BENGATTAF Soraya, Anjou

U16M -42JO

Competitors/Compétiteurs

#	Name/Nom	Grade	Club	1	2	1	2	1	2	W/G	Pts	Pos
1	LAROSE Thomas	Orange/vert	St-Jean Bosco							0	0	2
2	SAURIOL Nathan	Orange/vert	Blainville	10		7				2	17	1

Matches/Matches

Match	White/Blanc			Blue/Bleu	Res/Rés	Tim/Tmp	Code
E-11	LAROSE Thomas	1	2	SAURIOL Nathan	0 - 10	1:22	WIP
E-22	LAROSE Thomas	1	2	SAURIOL Nathan	0 - 7	3:00	WAZ
E-33	LAROSE Thomas	1	2	SAURIOL Nathan			

Results/Résultats

Pos	Name/Nom
1	SAURIOL Nathan, Blainville

U16M -46JO

Competitors/Compétiteurs

#	Name/Nom	Grade	Club	1	2	3	4	5	W/G	Pts	Pos
1	TADJOURI Zahrouni	Orange/vert	Anjou		10		5	10	3	25	3
2	VIZIAU Tristan	Orange	St-Paul l'Ermite						0	0	5
3	COUTURIER xavier	Orange	CJVR	10	10			10	3	30	2
4	LAPORTE Antoine	Orange	St-Hyacinthe		10	10		10	3	30	1
5	MAYRAND Samuel	Jaune/Orange	Juvaldo		10				1	10	4

Matches/Matches

Match	White/Blanc			Blue/Bleu	Res/Rés	Tim/Tmp	Code
E-1	LAPORTE Antoine	4	5	MAYRAND Samuel	10 - 0	1:36	IPO
E-2	TADJOURI Zahrouni	1	2	VIZIAU Tristan	10 - 0	0:11	IPO
E-14	COUTURIER xavier	3	4	LAPORTE Antoine	0 - 10	0:20	IPO
E-15	TADJOURI Zahrouni	1	5	MAYRAND Samuel	10 - 0	0:59	WIP
E-25	VIZIAU Tristan	2	3	COUTURIER xavier	0 - 10	0:14	IPO
E-26	TADJOURI Zahrouni	1	4	LAPORTE Antoine	5 - 0	3:00	YUK
E-36	COUTURIER xavier	3	5	MAYRAND Samuel	10 - 0	0:41	WIP
E-37	VIZIAU Tristan	2	4	LAPORTE Antoine	0 - 10	0:26	WIP
E-42	TADJOURI Zahrouni	1	3	COUTURIER xavier	0 - 10	1:19	IPO
E-43	VIZIAU Tristan	2	5	MAYRAND Samuel	0 - 10	0:49	IPO

Results/Résultats

Pos	Name/Nom
1	LAPORTE Antoine, St-Hyacinthe
2	COUTURIER xavier, CJVR
3	TADJOURI Zahrouni, Anjou
4	MAYRAND Samuel, Juvaldo

U16M -66JO

Competitors/Compétiteurs

#	Name/Nom	Grade	Club	1	2	3	W/G	Pts	Pos
1	CROITORU Artur	Orange	Anjou			10	1	10	3
2	HOUNGBEDJI Loïc	Jaune	St-Paul l'Ermite	10			1	10	2
3	BEAUDOIN Migaël	Orange	Métropolitain		10		1	10	1

Matches/Matches

Match	White/Blanc			Blue/Bleu	Res/Rés	Tim/Tmp	Code
E-13	CROITORU Artur	1	2	HOUNGBEDJI Loïc	0 - 10	0:13	IPO
E-24	CROITORU Artur	1	3	BEAUDOIN Migaël	10 - 0	0:47	IPO
E-35	HOUNGBEDJI Loïc	2	3	BEAUDOIN Migaël	0 - 10	1:25	IPO

Results/Résultats

Pos	Name/Nom
1	BEAUDOIN Migaël, Métropolitain
2	HOUNGBEDJI Loïc, St-Paul l'Ermite
3	CROITORU Artur, Anjou

U16M -38VBM

Competitors/Compétiteurs A

#	Name/Nom	Grade	Club	1	2	3	W/G	Pts	Pos
1	TREMBLAY Justin	Vert/Bleu	SEIKIDOKAN			10	1	10	2
2	NUARA Adam	Bleu/Maroon	Shidokan	10		10	2	20	1
3	LABRIE Raphael	Bleu	To-hakukan				0	0	3

Matches/Matches A

Match	White/Blanc	Blue/Bleu	Res/Rés	Tim/Tmp	Code
A-14	TREMBLAY Justin	1 2 NUARA Adam	0 - 10	2:48	IPO
A-25	TREMBLAY Justin	1 3 LABRIE Raphael	10 - 0	3:00	IPO
A-31	NUARA Adam	2 3 LABRIE Raphael	10 - 0	1:28	WIP

Competitors/Compétiteurs B

#	Name/Nom	Grade	Club	4	5	6	W/G	Pts	Pos
4	ELIAS Afanasiev	Vert	Seidokwan		10		1	10	2
5	LAPOINTE Mathias	Vert	Kime-Waza				0	0	3
6	BLACKIÈRE Arno	Bleu	J.Jonquiere	10	10		2	20	1

Matches/Matches B

Match	White/Blanc	Blue/Bleu	Res/Rés	Tim/Tmp	Code
A-15	ELIAS Afanasiev	4 5 LAPOINTE Mathias	10 - 0	0:42	IPO
A-26	ELIAS Afanasiev	4 6 BLACKIÈRE Arno	0 - 10	1:09	IPO
A-32	LAPOINTE Mathias	5 6 BLACKIÈRE Arno	0 - 10	0:26	IPO

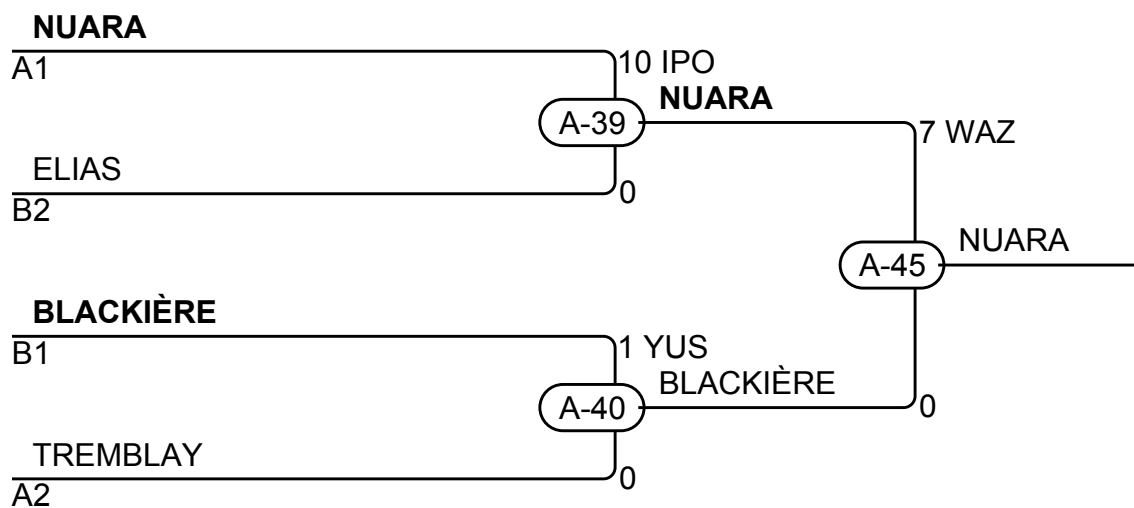

Results/Résultats

Pos	Name/Nom
1	NUARA Adam, Shidokan
2	BLACKIÈRE Arno, J.Jonquiere
3	ELIAS Afanasiev, Seidokwan
3	TREMBLAY Justin, SEIKIDOKAN

U16M -42VBM

Competitors/Compétiteurs A

#	Name/Nom	Grade	Club	1	2	3	4	W/G	Pts	Pos
1	MAKOUMBOU Dieu-Règne	Vert	SEIKIDOKAN				10	1	10	3
2	DROLET Emile	Vert	Albatros	10			10	2	20	2
3	GAGNÉ Émile	Bleu	Seiko	10	7		10	3	27	1
4	DESBIENS Jacob	Vert	J.Jonquiere					0	0	4

Matches/Matches A

Match	White/Blanc	Blue/Bleu	Res/Rés	Tim/Tmp	Code
E-3	MAKOUMBOU Dieu-Règne 1 2	DROLET Emile	0 - 10	0:05	IPO
E-4	GAGNÉ Émile 3 4	DESBIENS Jacob	10 - 0	0:24	IPO
E-16	MAKOUMBOU Dieu-Règne 1 3	GAGNÉ Émile	0 - 10	0:50	IPO
E-17	DROLET Emile 2 4	DESBIENS Jacob	10 - 0	1:20	IPO
E-27	MAKOUMBOU Dieu-Règne 1 4	DESBIENS Jacob	10 - 0	0:04	IPO
E-28	DROLET Emile 2 3	GAGNÉ Émile	0 - 7	3:00	WAZ

Competitors/Compétiteurs B

#	Name/Nom	Grade	Club	5	6	7	W/G	Pts	Pos
5	LABRECQUE Christofer	Vert	Albatros				0	0	3
6	GAUTHIER Marcus	Vert/Bleu	J.Jonquiere	10			1	10	2
7	CARBONNEAU Loïc	Vert	Boucherville	10	10		2	20	1

Matches/Matches B

Match	White/Blanc	Blue/Bleu	Res/Rés	Tim/Tmp	Code
E-5	LABRECQUE Christofer 5 6	GAUTHIER Marcus	0 - 10	0:26	WIP
E-18	LABRECQUE Christofer 5 7	CARBONNEAU Loïc	0 - 10	0:27	WIP
E-29	GAUTHIER Marcus 6 7	CARBONNEAU Loïc	0 - 10	0:52	WIP

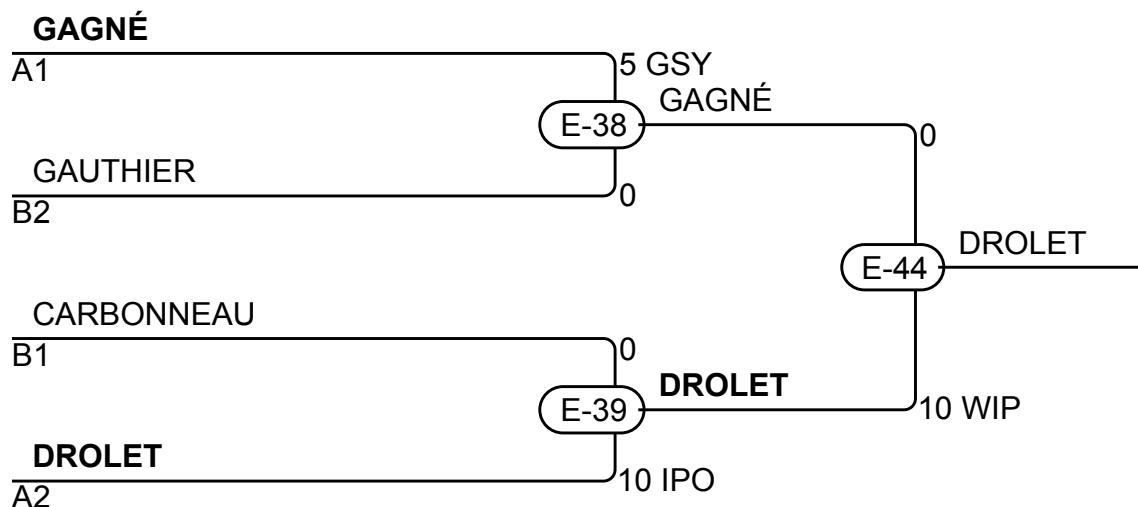

Results/Résultats

Pos	Name/Nom
1	DROLET Emile, Albatros
2	GAGNÉ Émile, Seiko
3	GAUTHIER Marcus, J.Jonquiere
3	CARBONNEAU Loïc, Boucherville

U16M -46VBM

Competitors/Compétiteurs

#	Name/Nom	Grade	Club	1	2	3	4	W/G	Pts	Pos
1	TURCAN Trojan	Vert	Shidokan					0	0	4
2	ESCOLAR Thomas	Bleu	Shidokan	5		10		2	15	2
3	GAUTHIER-DRAPEAU Antoine	Marron	Seiko	1				1	1	3
4	DESROCHERS Vincent	Marron	Victo	10	10	10		3	30	1

Matches/Matches

Match	White/Blanc			Blue/Bleu	Res/Rés	Tim/Tmp	Code
C-12	TURCAN Trojan	1	2	ESCOLAR Thomas	0 - 5	3:00	YUK
C-13	GAUTHIER-DRAPEAU Antoine	3	4	DESROCHERS Vincent	0 - 10	0:16	IPO
C-25	TURCAN Trojan	1	3	GAUTHIER-DRAPEAU Antoine	0 - 1	3:00	YUS
C-26	ESCOLAR Thomas	2	4	DESROCHERS Vincent	0 - 10	1:34	IPO
C-37	TURCAN Trojan	1	4	DESROCHERS Vincent	0 - 10	0:24	IPO
C-38	ESCOLAR Thomas	2	3	GAUTHIER-DRAPEAU Antoine	10 - 0	0:57	IPO

Results/Résultats

Pos	Name/Nom
1	DESROCHERS Vincent, Victo
2	ESCOLAR Thomas, Shidokan
3	GAUTHIER-DRAPEAU Antoine, Seiko

U16M -50VBM

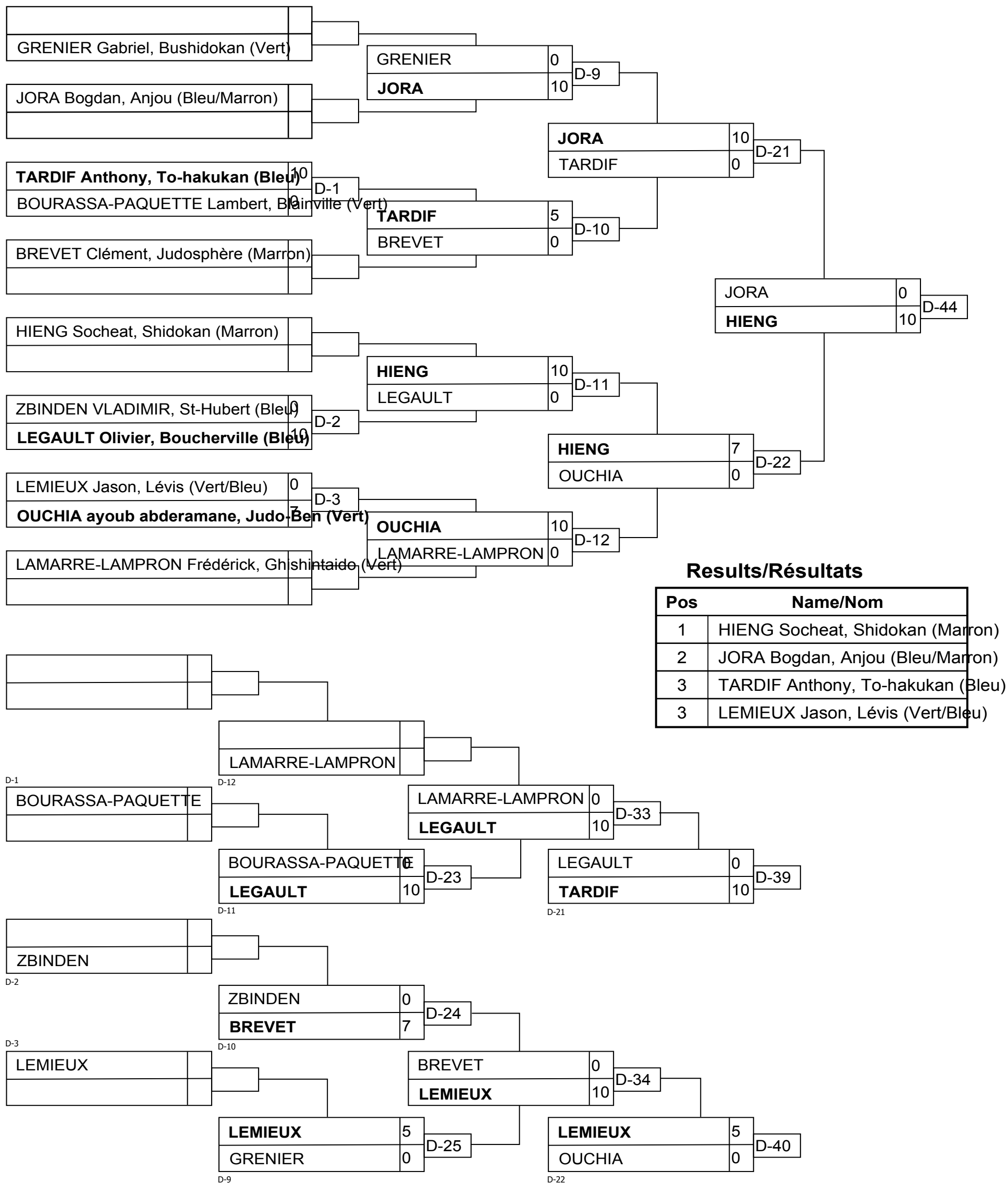

U16M -55VBM

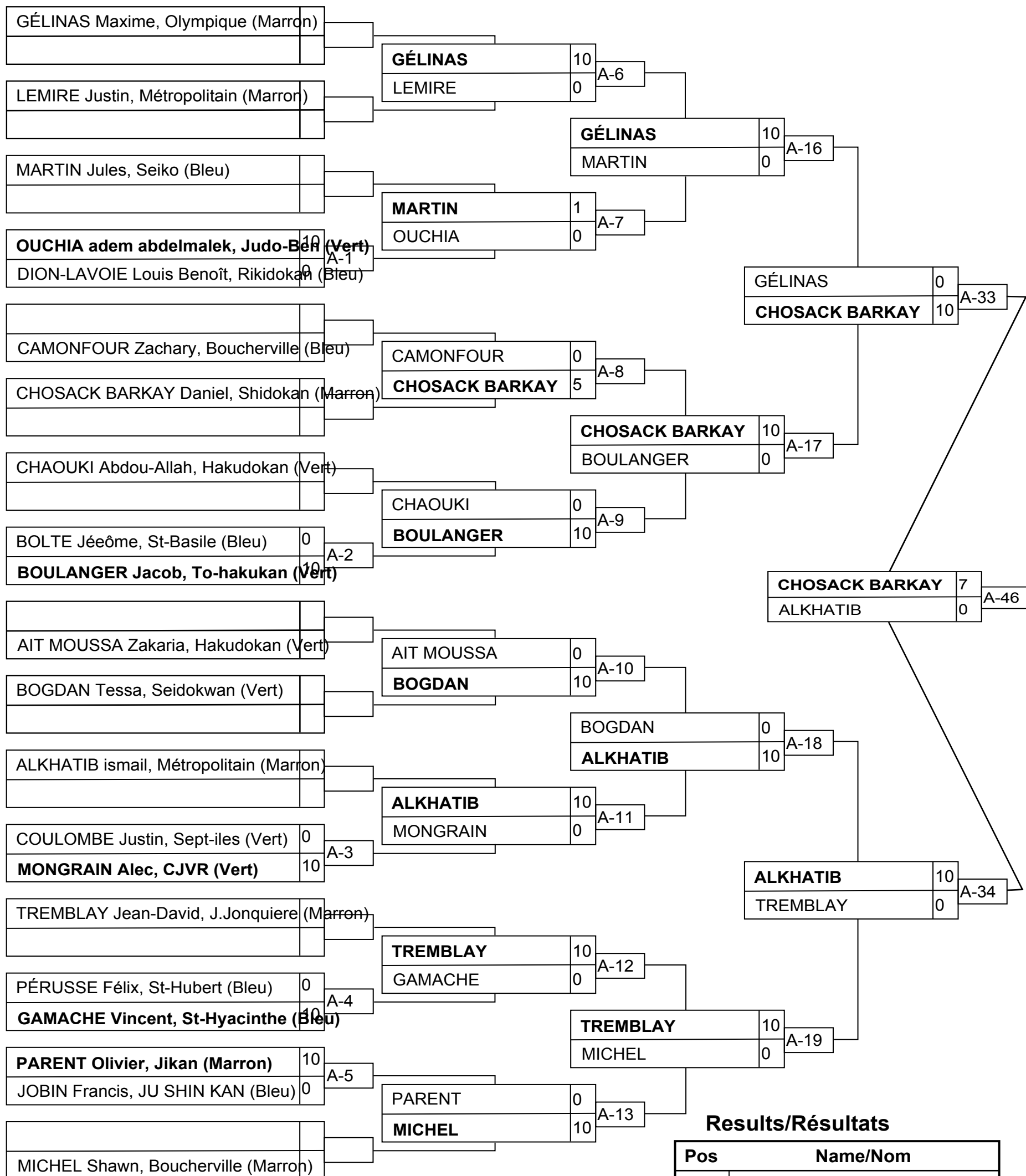

Results/Résultats

Pos	Name/Nom
1	CHOSACK BARKAY Daniel, Shidokan (Marron)
2	ALKHATIB ismail, Métropolitain (Marron)
3	GÉLINAS Maxime, Olympique (Marron)
3	TREMBLAY Jean-David, J.Jonquiere (Marron)

U16M -55VBM

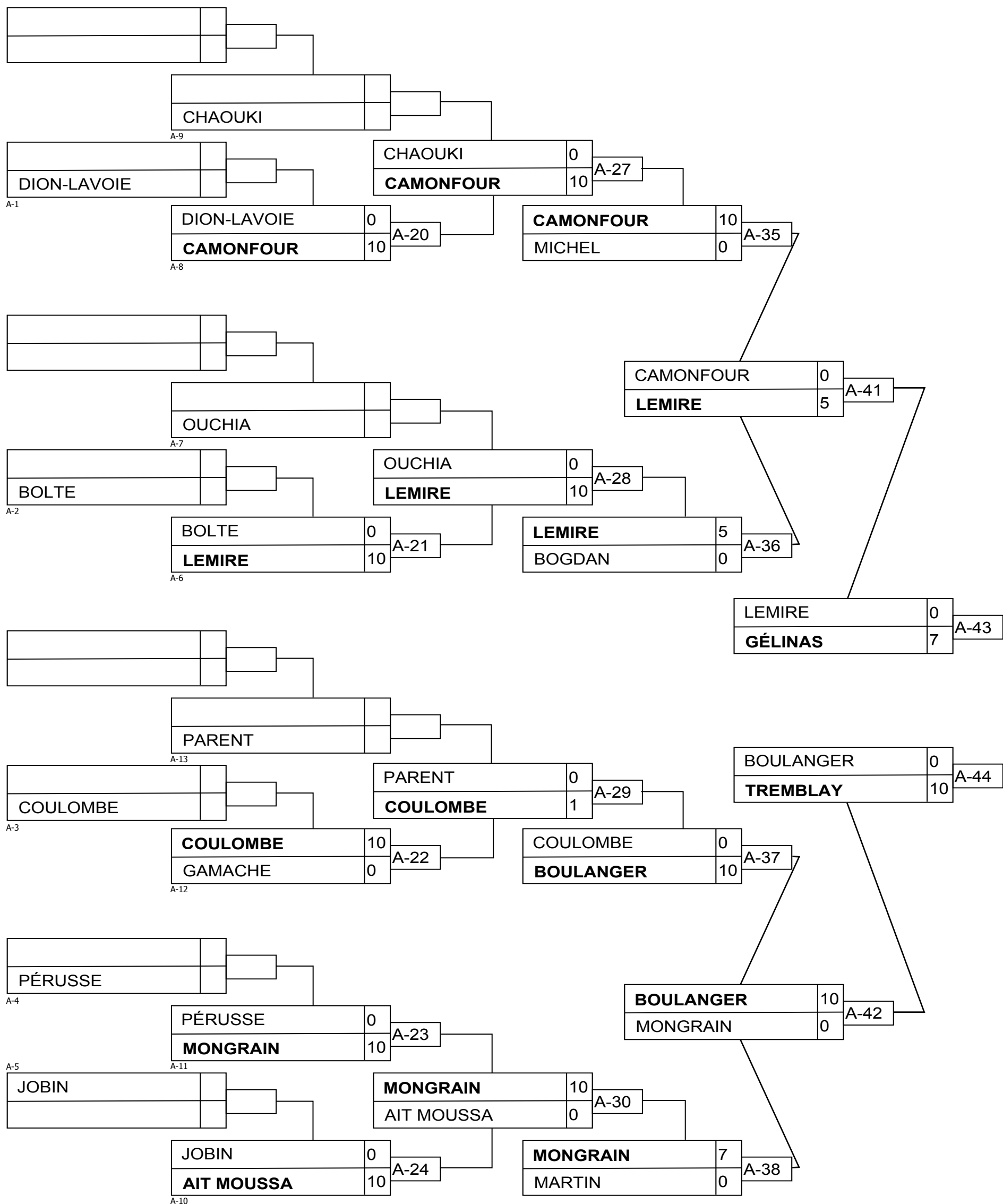

U16M -60VBM

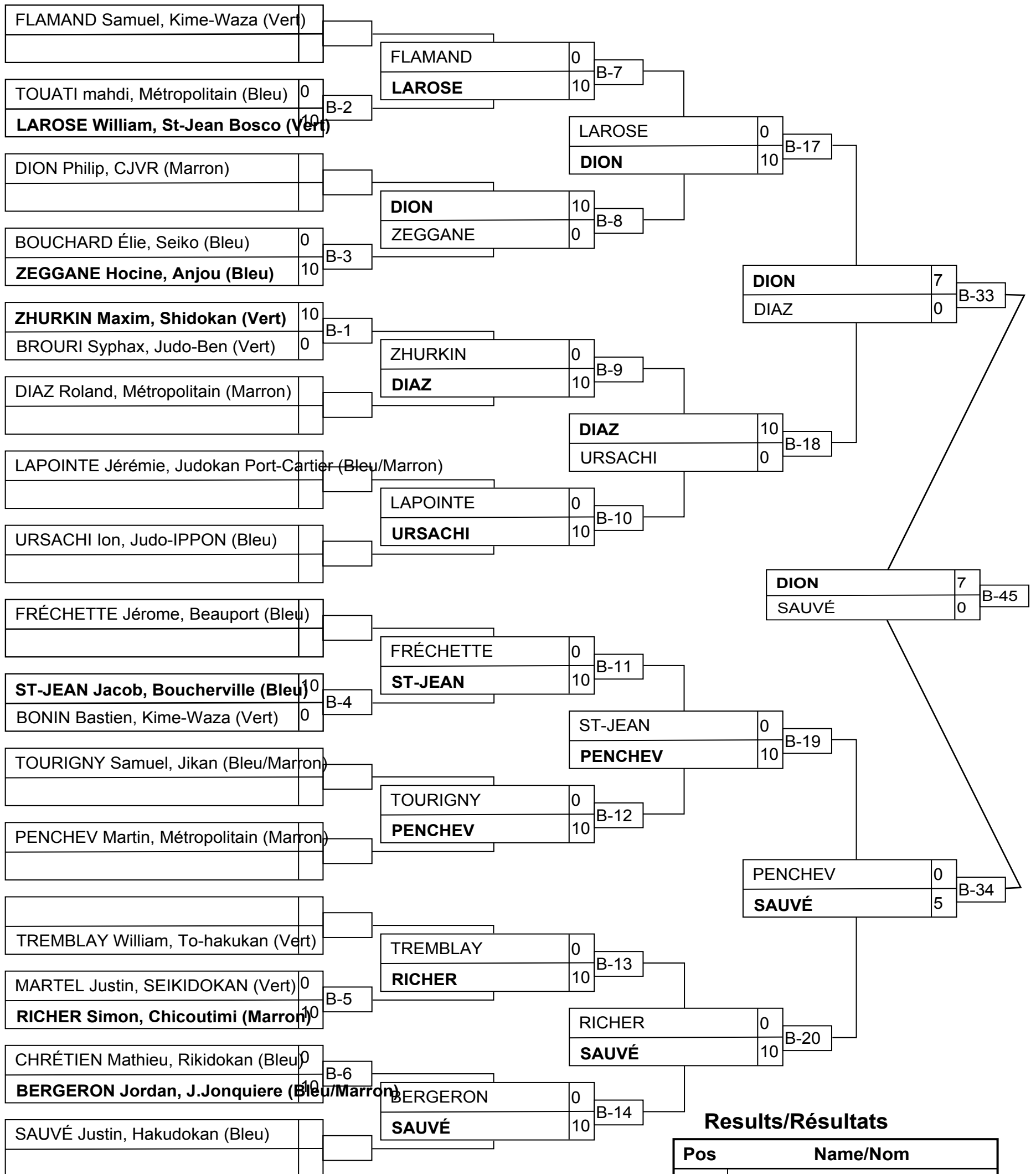

Results/Résultats

Pos	Name/Nom
1	DION Philip, CJVR (Marron)
2	SAUVÉ Justin, Hakudokan (Bleu)
3	DIAZ Roland, Métropolitain (Marron)
3	PENCHEV Martin, Métropolitain (Marron)

U16M -60VBM

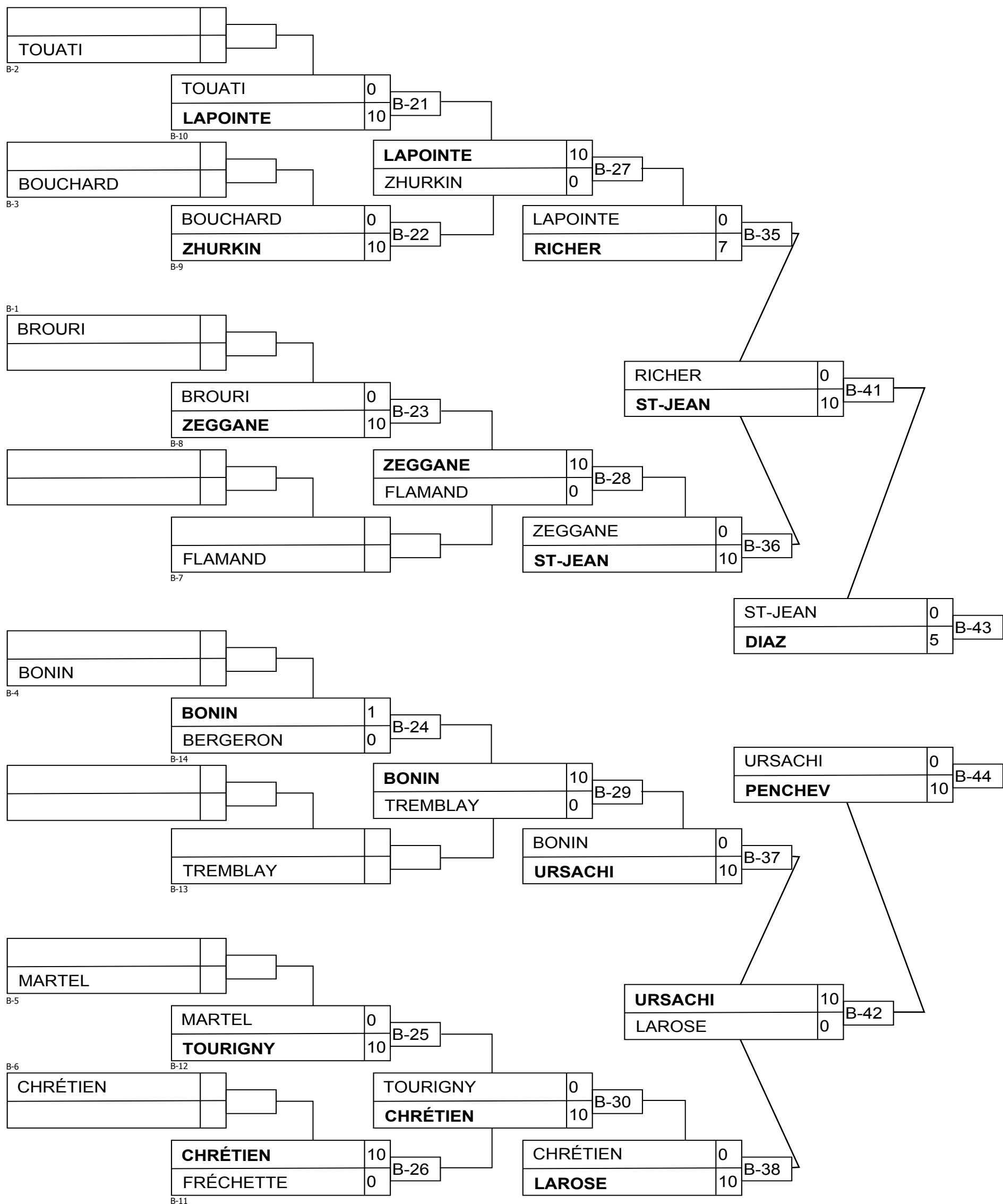

U16M -66VBM

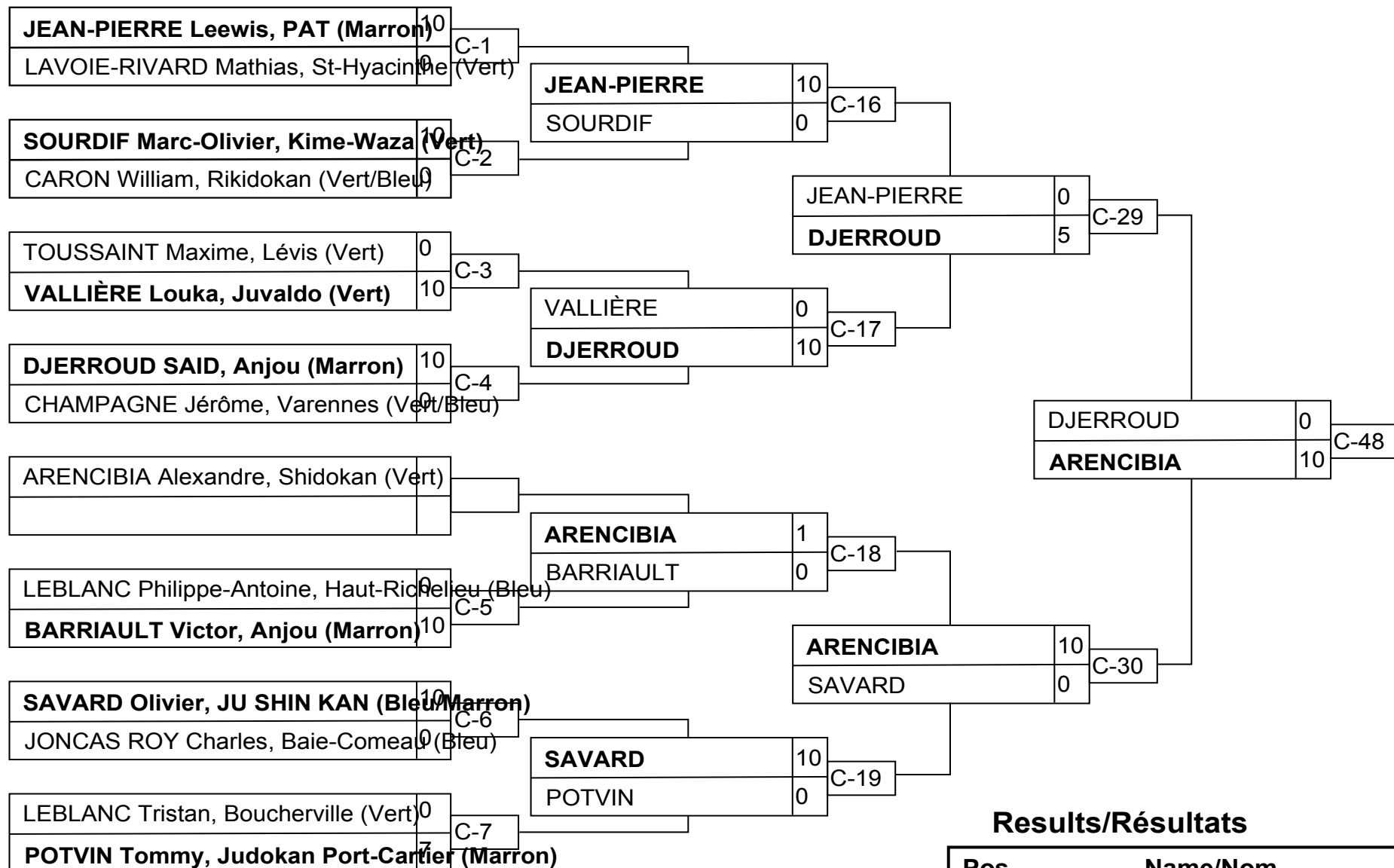

Results/Résultats

Pos	Name/Nom
1	ARENCIBIA Alexandre, Shidokan (Vert)
2	DJERROUD SAID, Anjou (Marron)
3	JEAN-PIERRE Leewis, PAT (Marron)
3	SAVARD Olivier, JU SHIN KAN (Bleu/Marron)

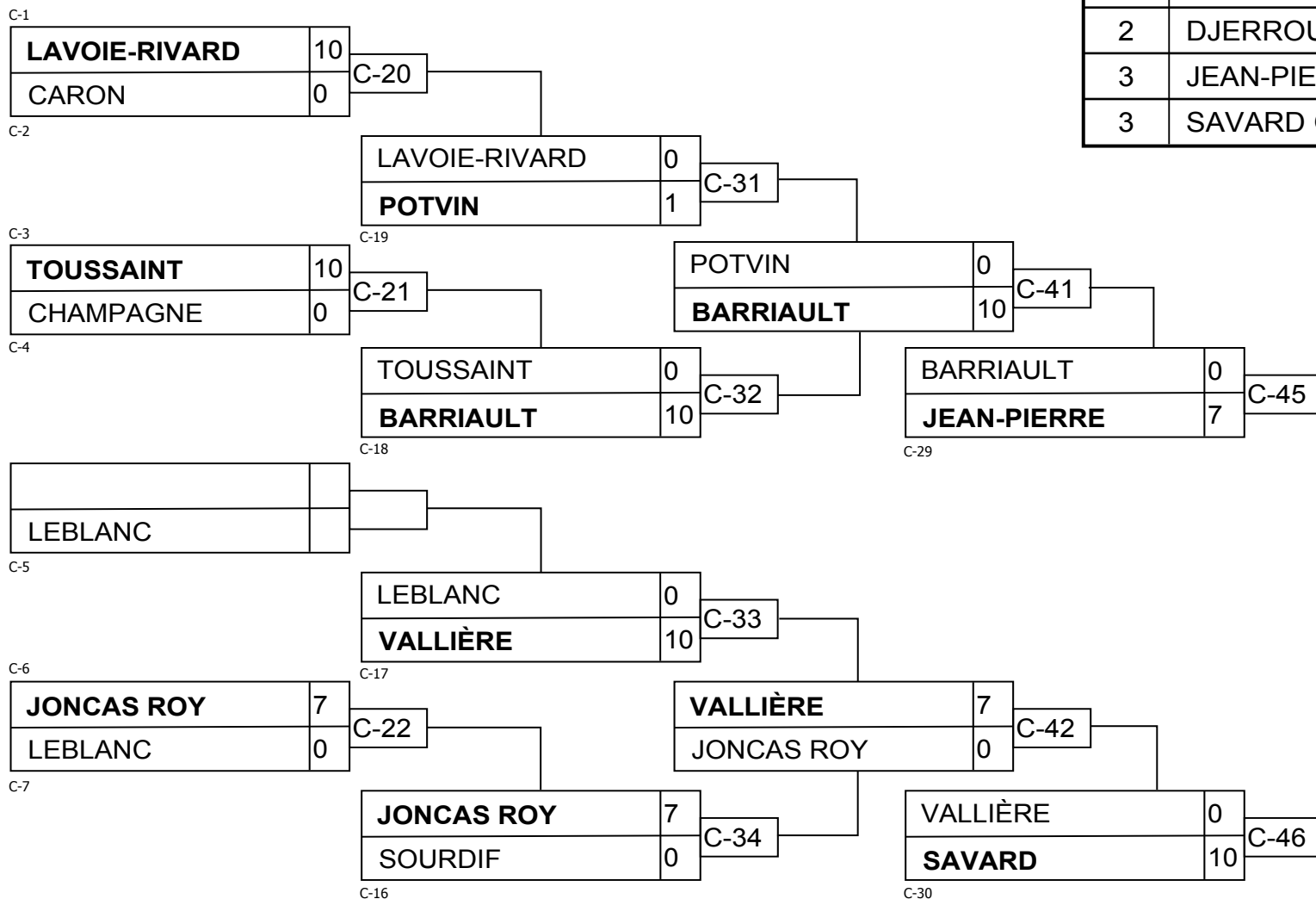

U16M -73VBM

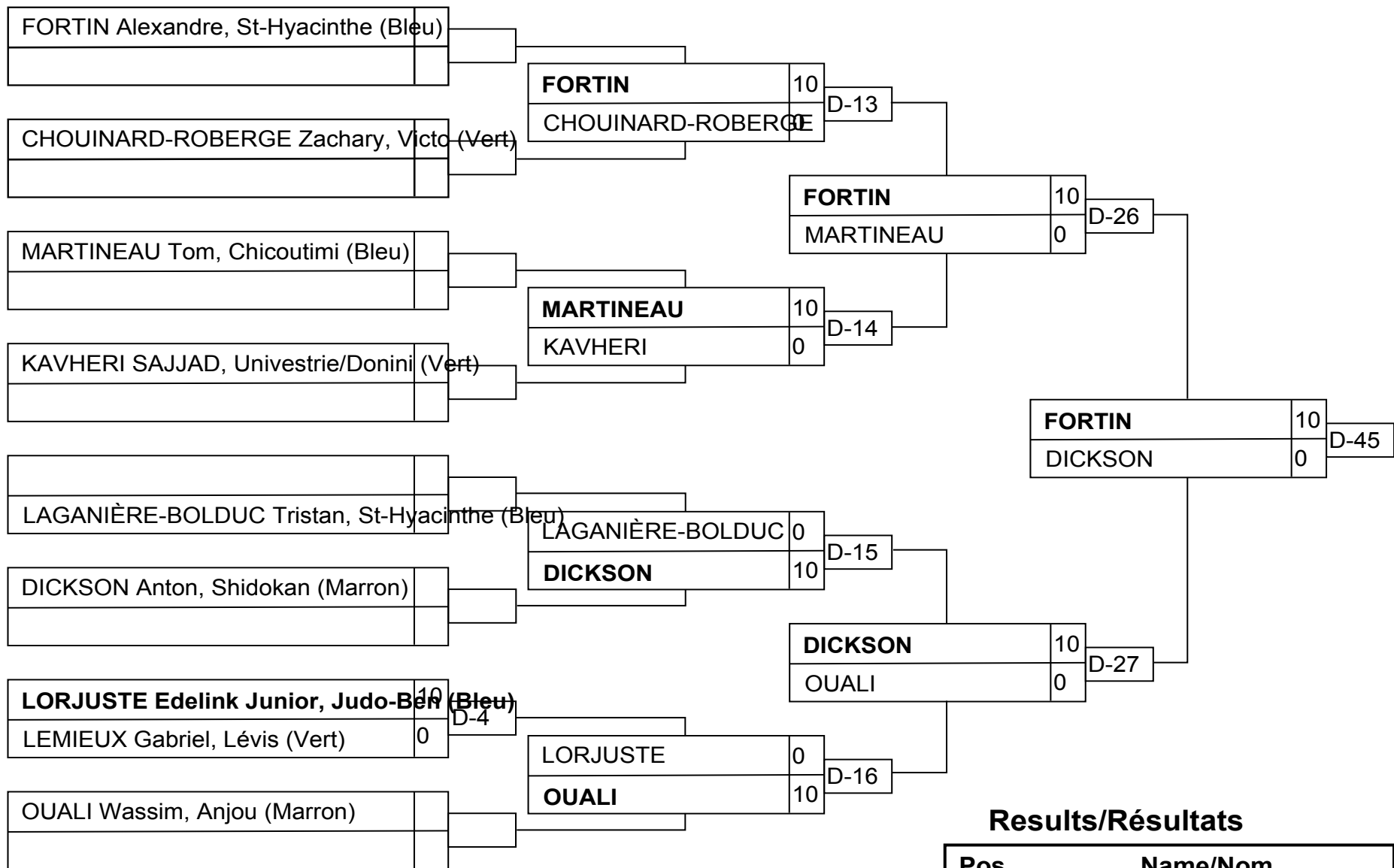

Results/Résultats

Pos	Name/Nom
1	FORTIN Alexandre, St-Hyacinthe (Bleu)
2	DICKSON Anton, Shidokan (Marron)
3	MARTINEAU Tom, Chicoutimi (Bleu)
3	OUALI Wassim, Anjou (Marron)

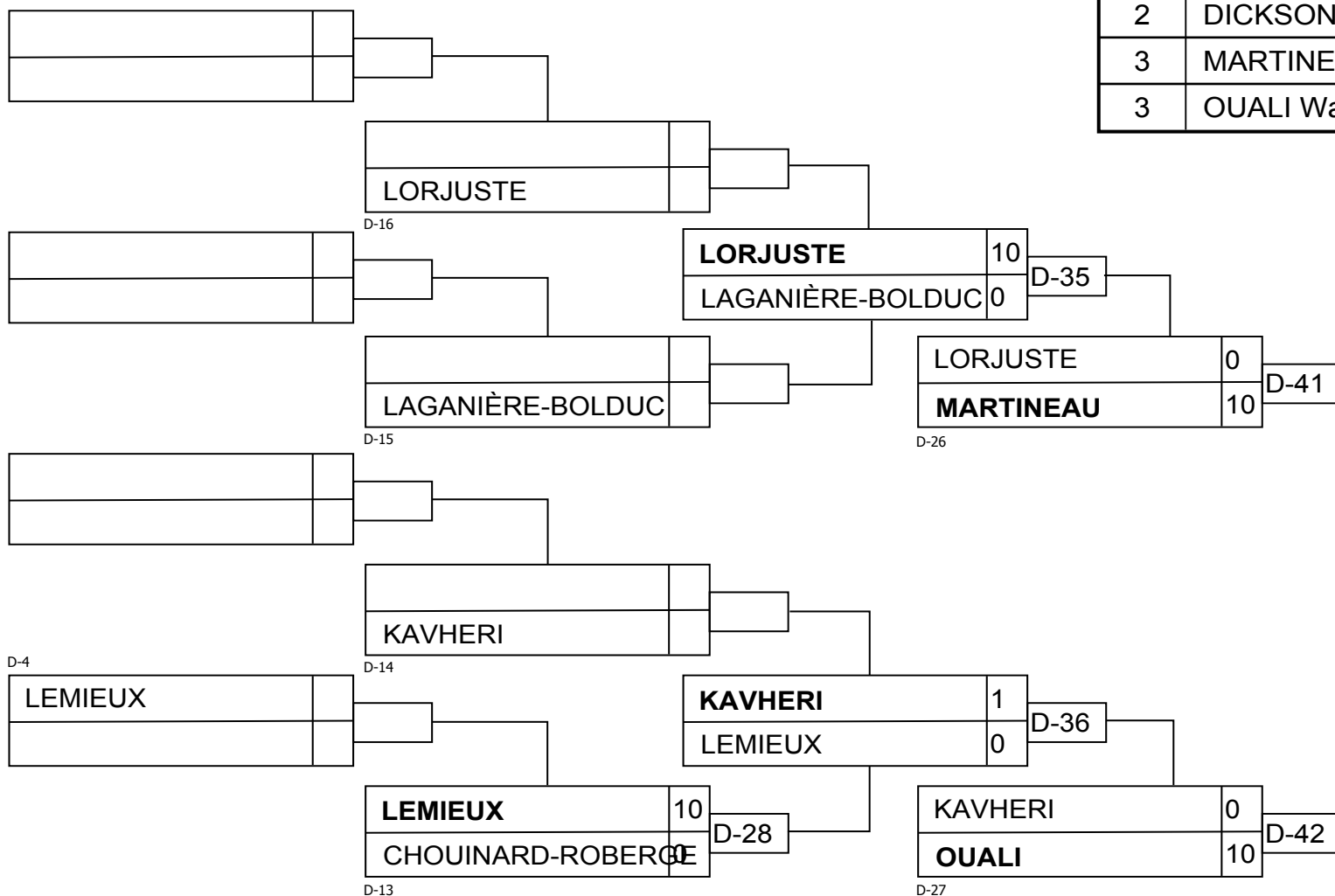

U16M +73VBM

Competitors/Compétiteurs

#	Name/Nom	Grade	Club	1	2	3	W/G	Pts	Pos
1	SEYE Norman	Vert	Olympique				0	0	3
2	OANCEA Sebastien	Orange	Olympique	10			1	10	2
3	COUTU xavier	Bleu	Métropolitain	10	10		2	20	1

Matches/Matches

Match	White/Blanc			Blue/Bleu	Res/Rés	Tim/Tmp	Code
B-16	SEYE Norman	1	2	OANCEA Sebastien	0 - 10	1:06	IPO
B-32	SEYE Norman	1	3	COUTU xavier	0 - 10	0:23	WIP
B-40	OANCEA Sebastien	2	3	COUTU xavier	0 - 10	1:35	IPO

Results/Résultats

Pos	Name/Nom
1	COUTU xavier, Métropolitain
2	OANCEA Sebastien, Olympique