

U18M -46

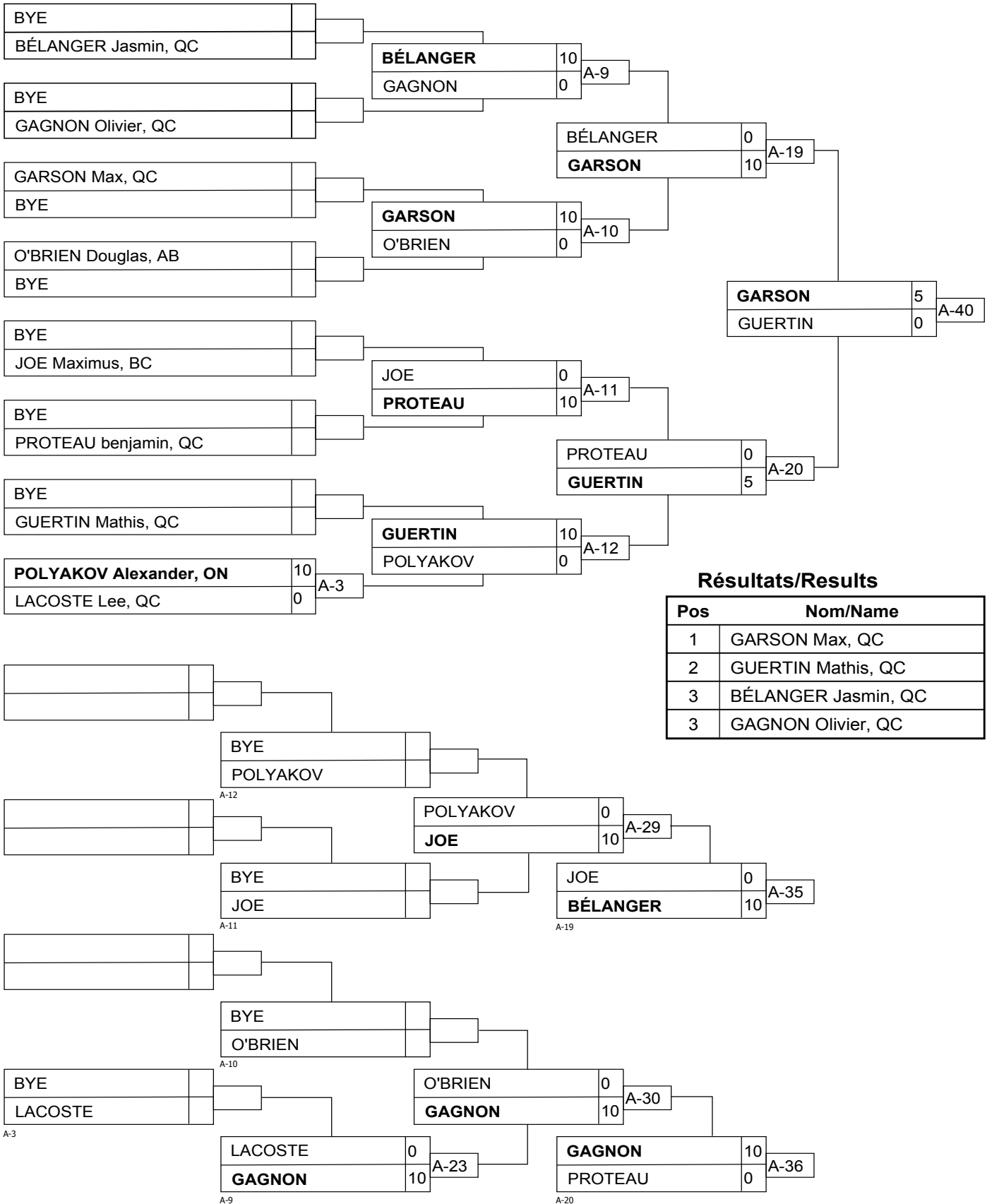

Résultats/Results

Pos	Nom/Name
1	GARSON Max, QC
2	GUERTIN Mathis, QC
3	BÉLANGER Jasmin, QC
3	GAGNON Olivier, QC

U18M -50

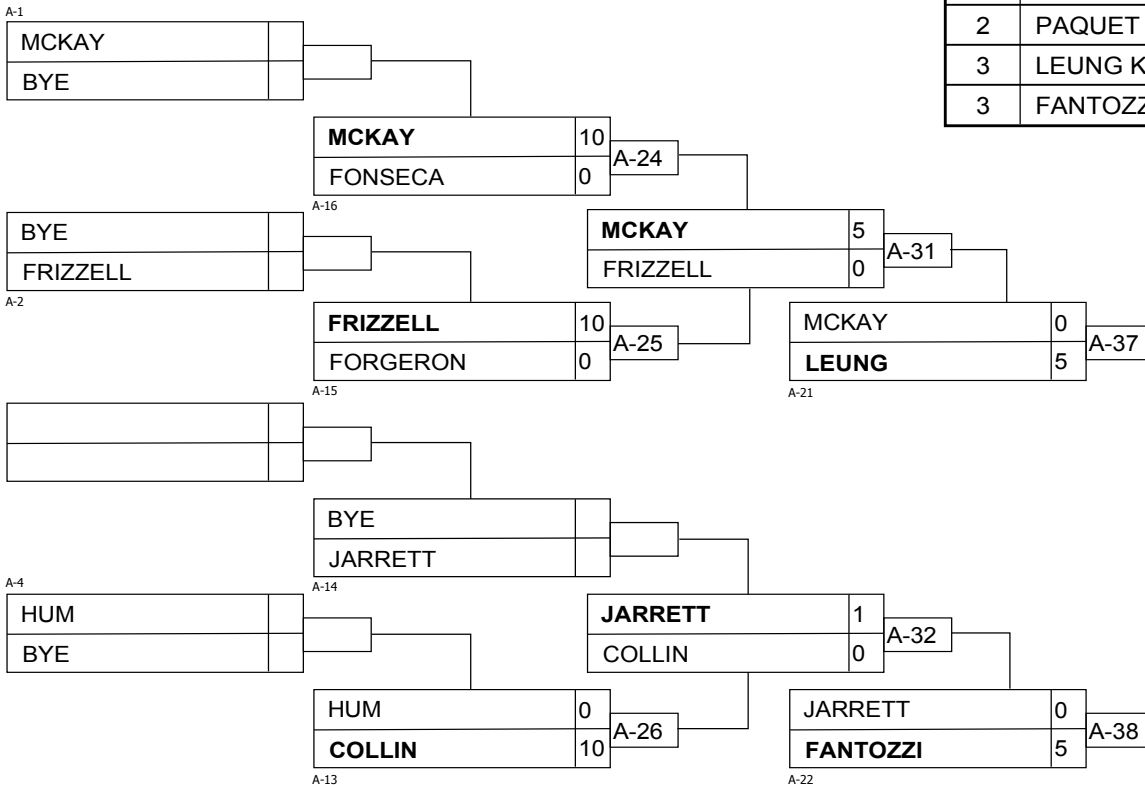
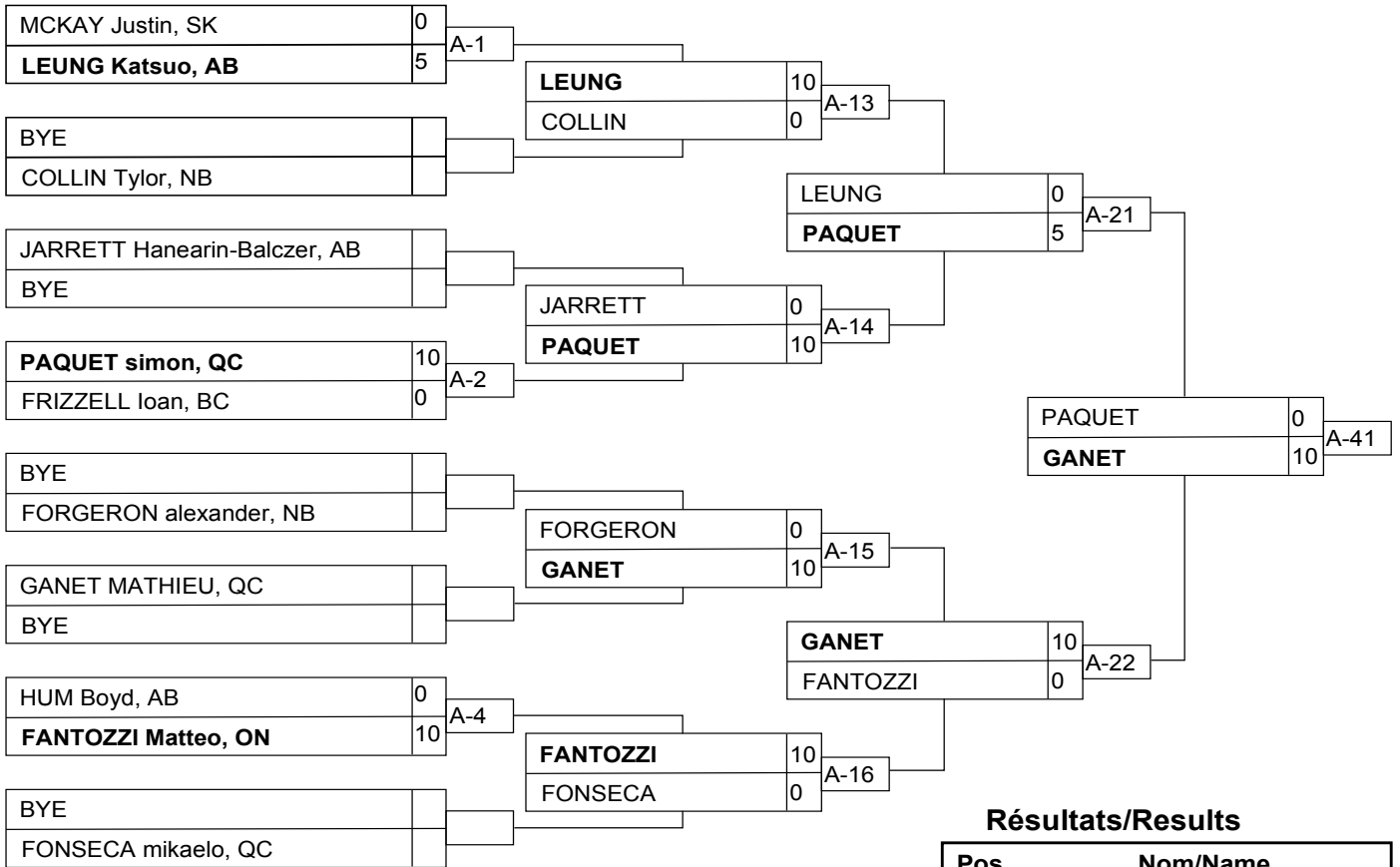

U18M -66

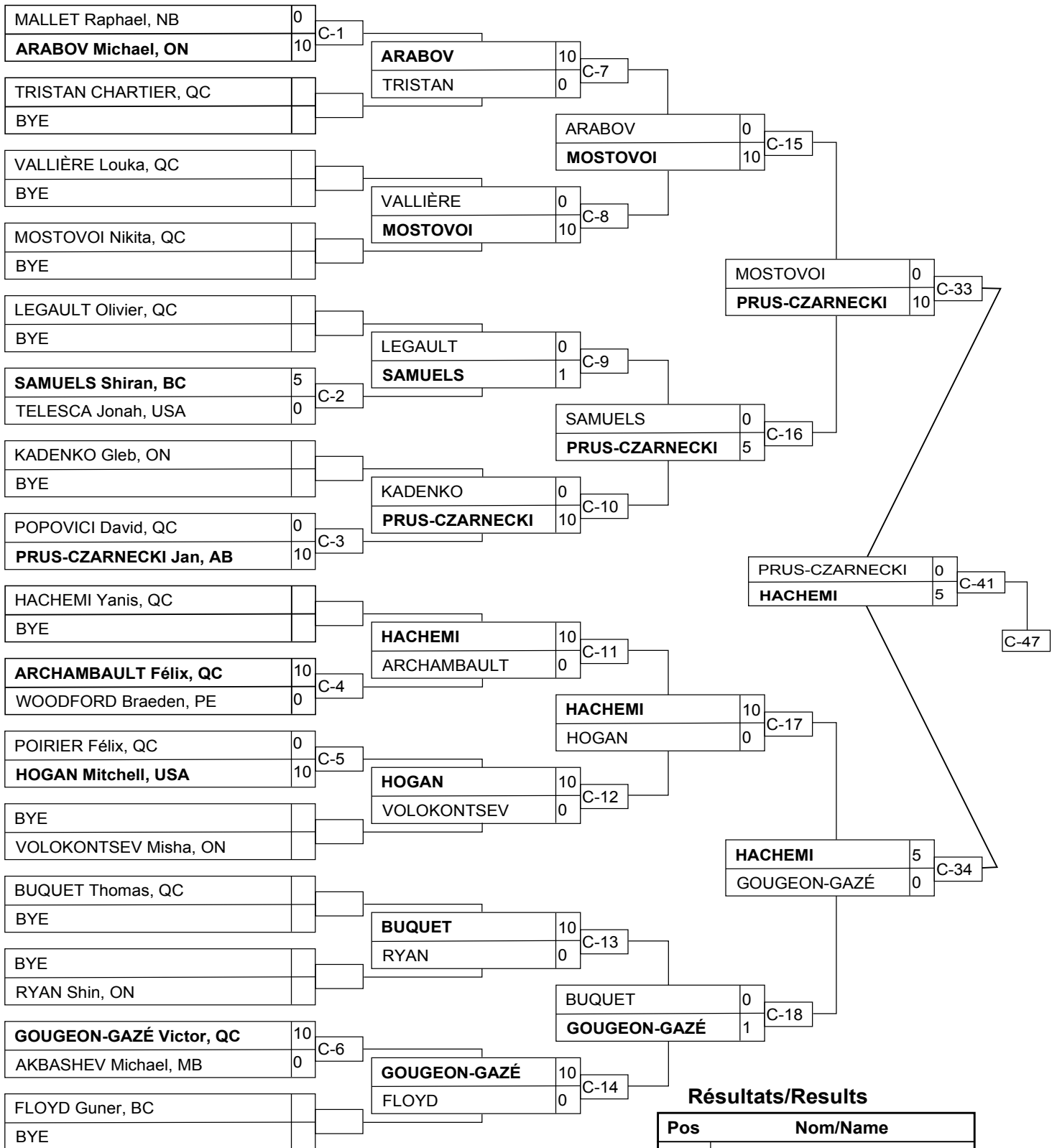

Résultats/Results

Pos	Nom/Name
1	YOUNG Keagan, ON
2	HACHEMI Yanis, QC
3	MICHAELSON tyler, USA
3	GOUGEON-GAZÉ Victor, QC

U18M -66

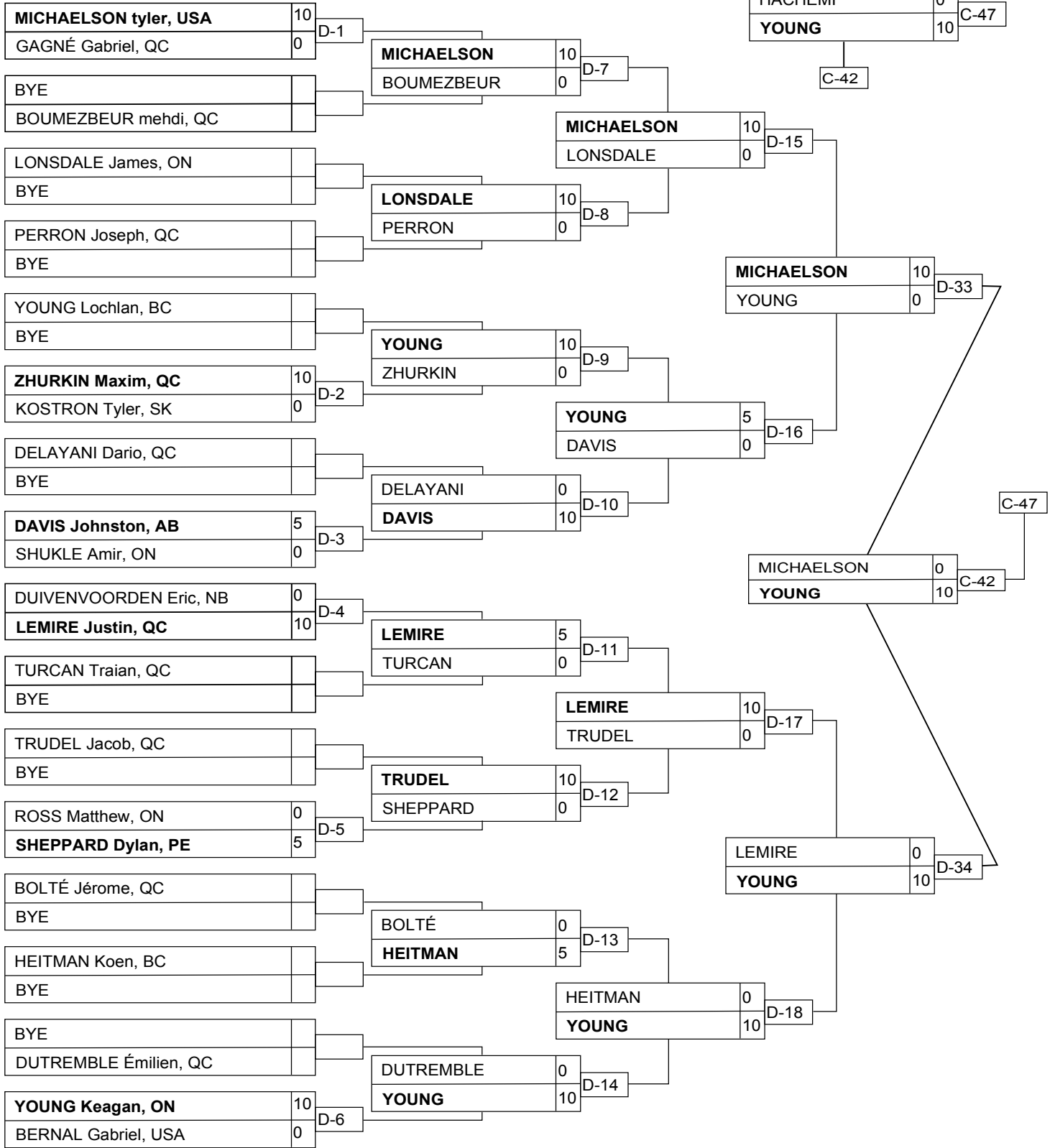

U18M -66

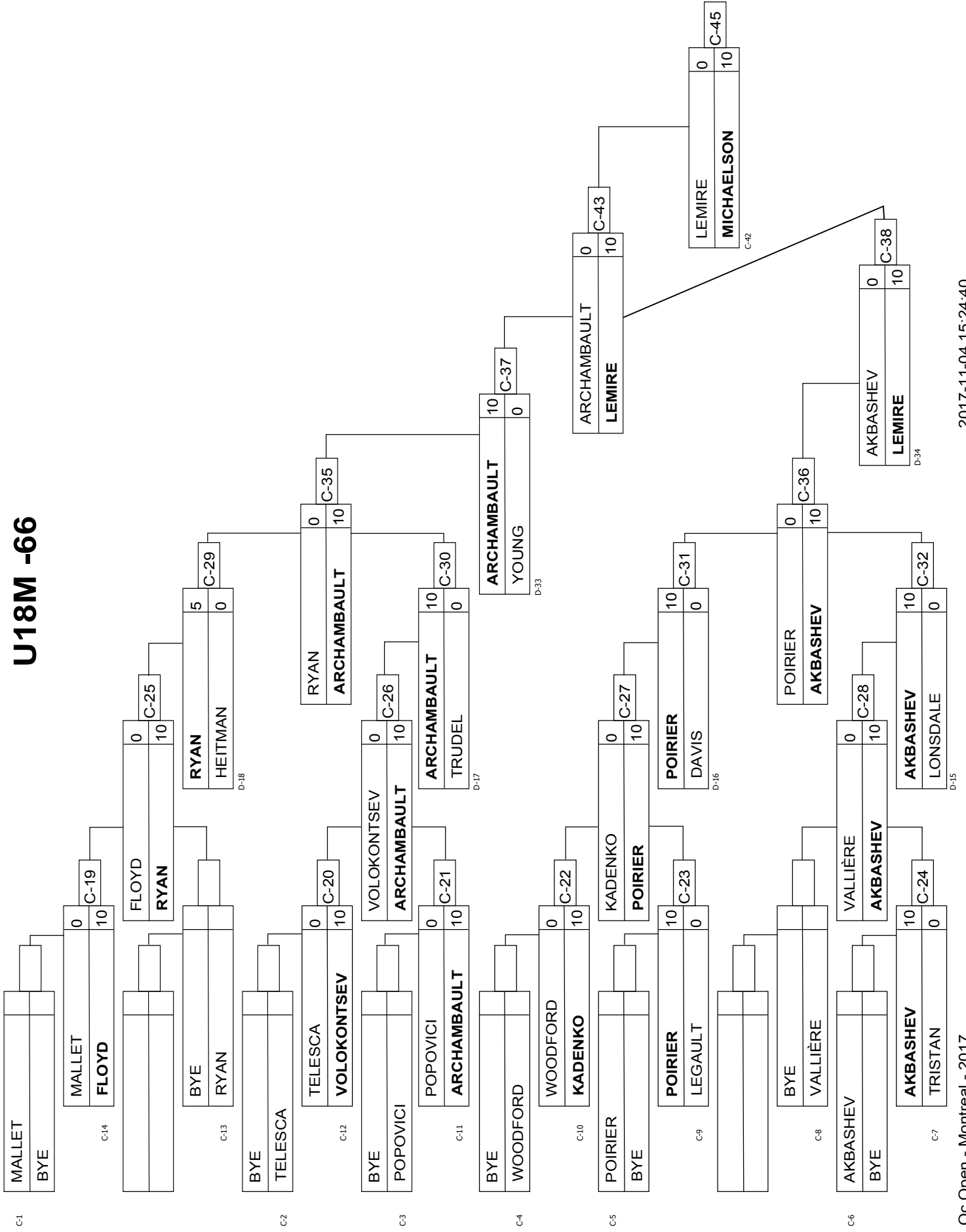

U18M -66

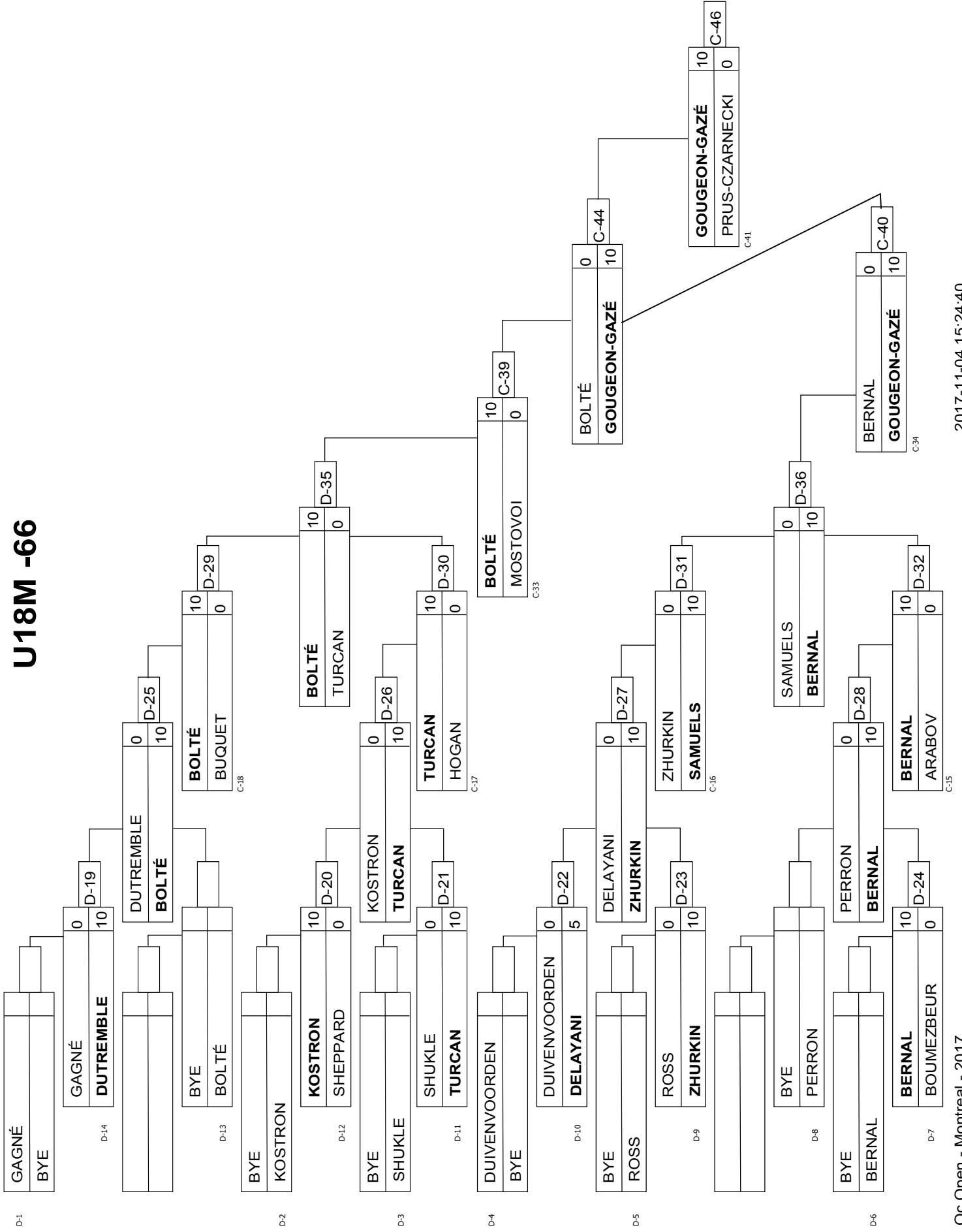

U18M -73

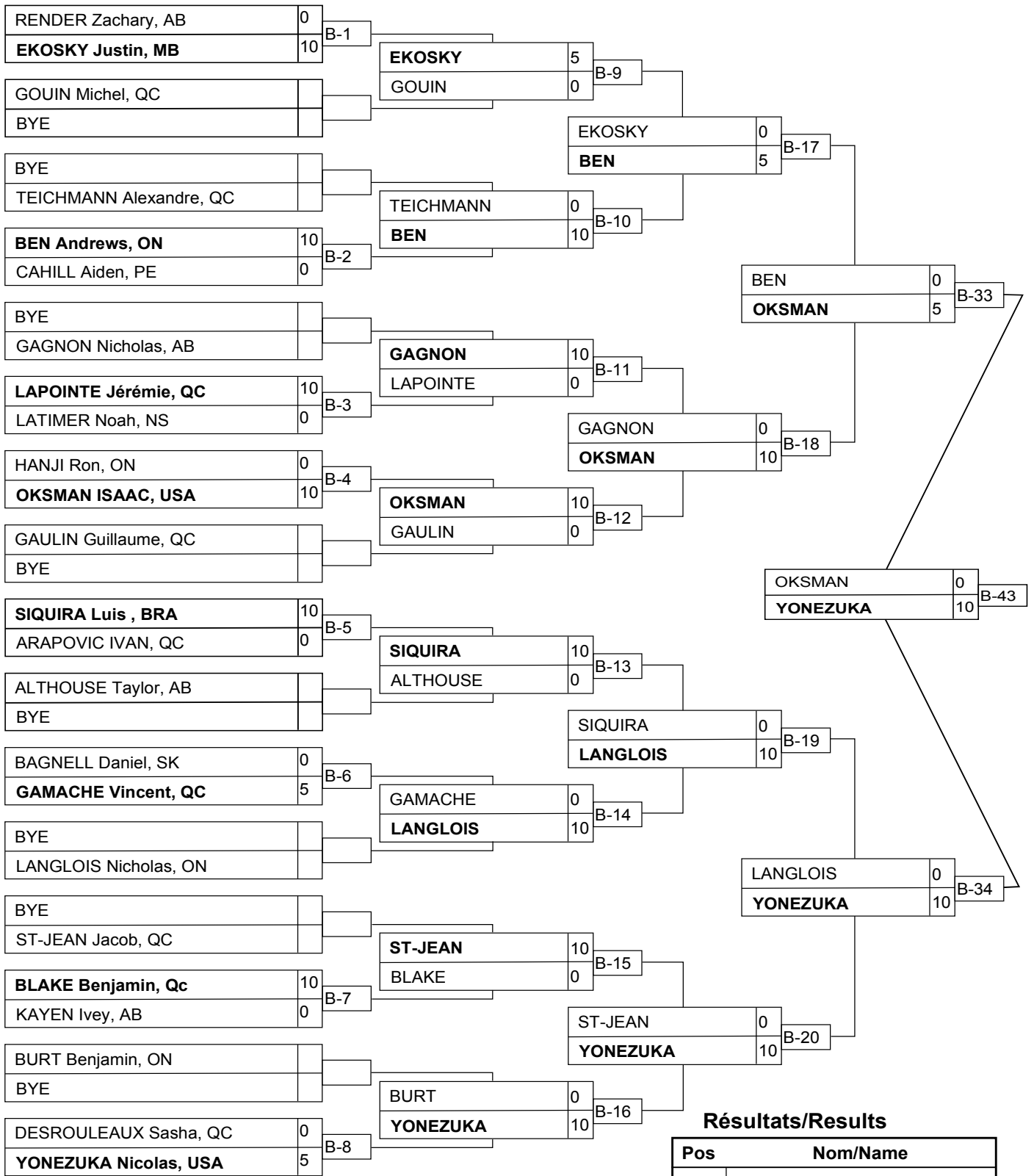

Résultats/Results

Pos	Nom/Name
1	YONEZUKA Nicolas, USA
2	OKSMAN ISAAC, USA
3	BEN Andrews, ON
3	LANGLOIS Nicholas, ON

U18M -73

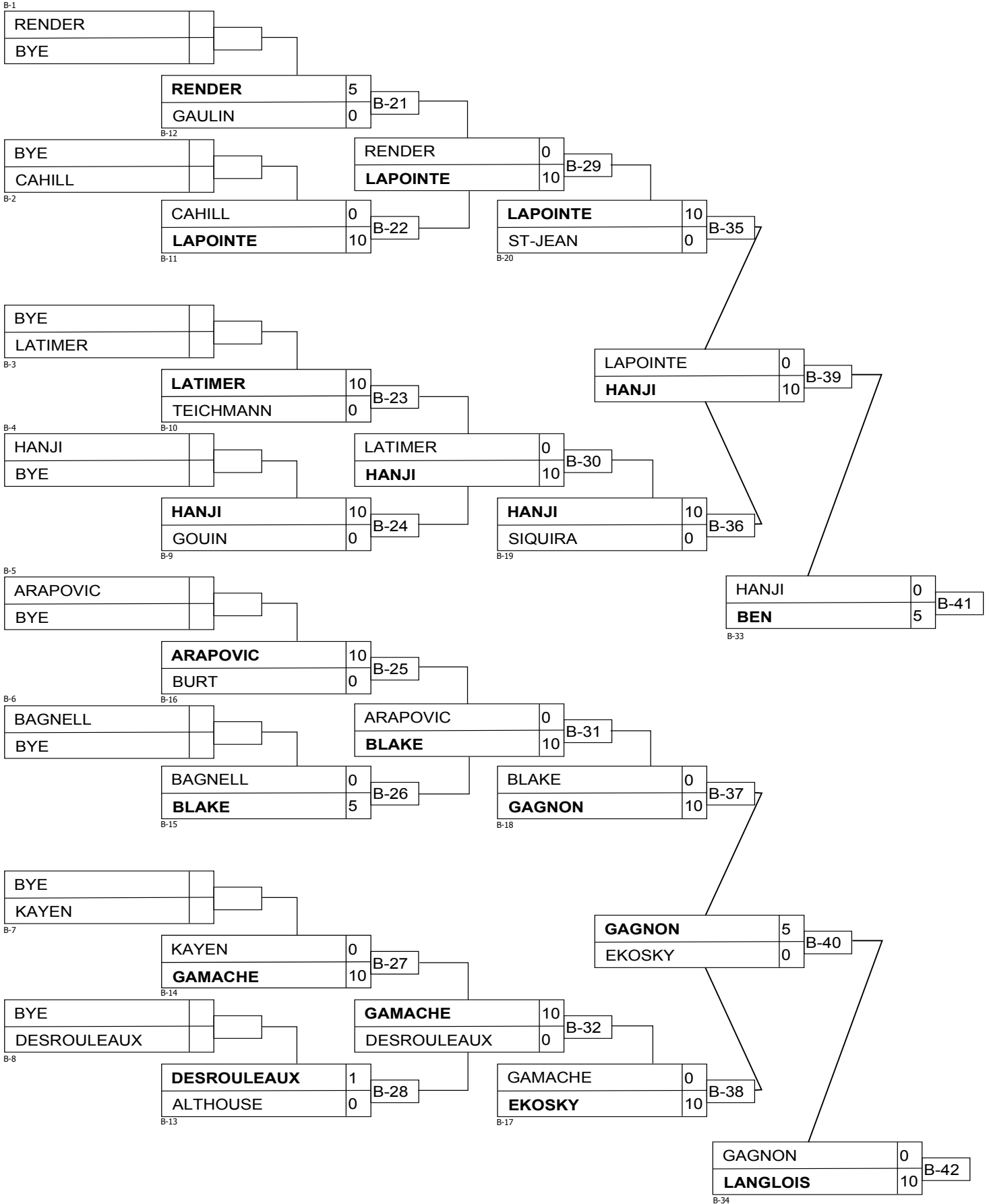

U18M -90

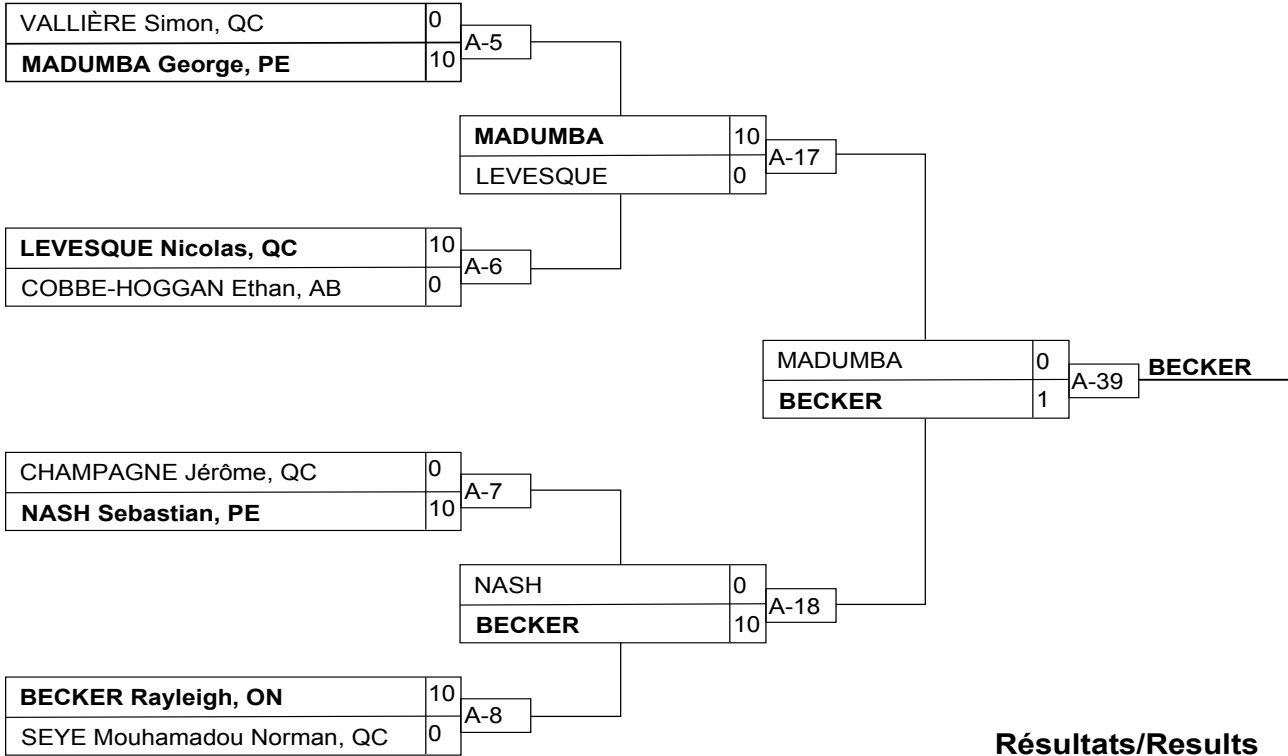

Résultats/Results

Pos	Nom/Name
1	BECKER Rayleigh, ON
2	MADUMBA George, PE
3	CHAMPAGNE Jérôme, QC
3	NASH Sebastian, PE

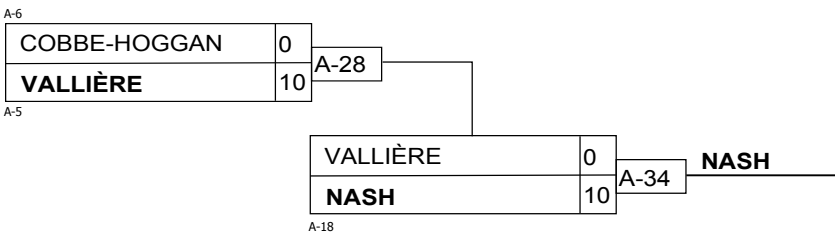
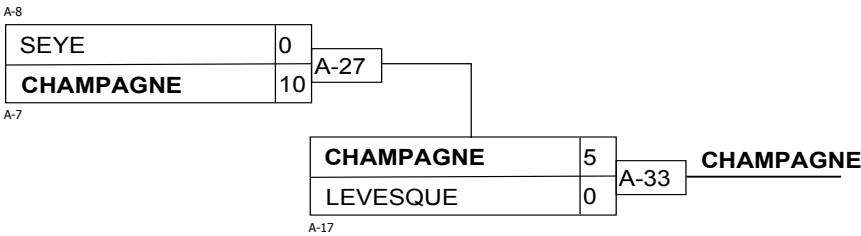

U18M -55

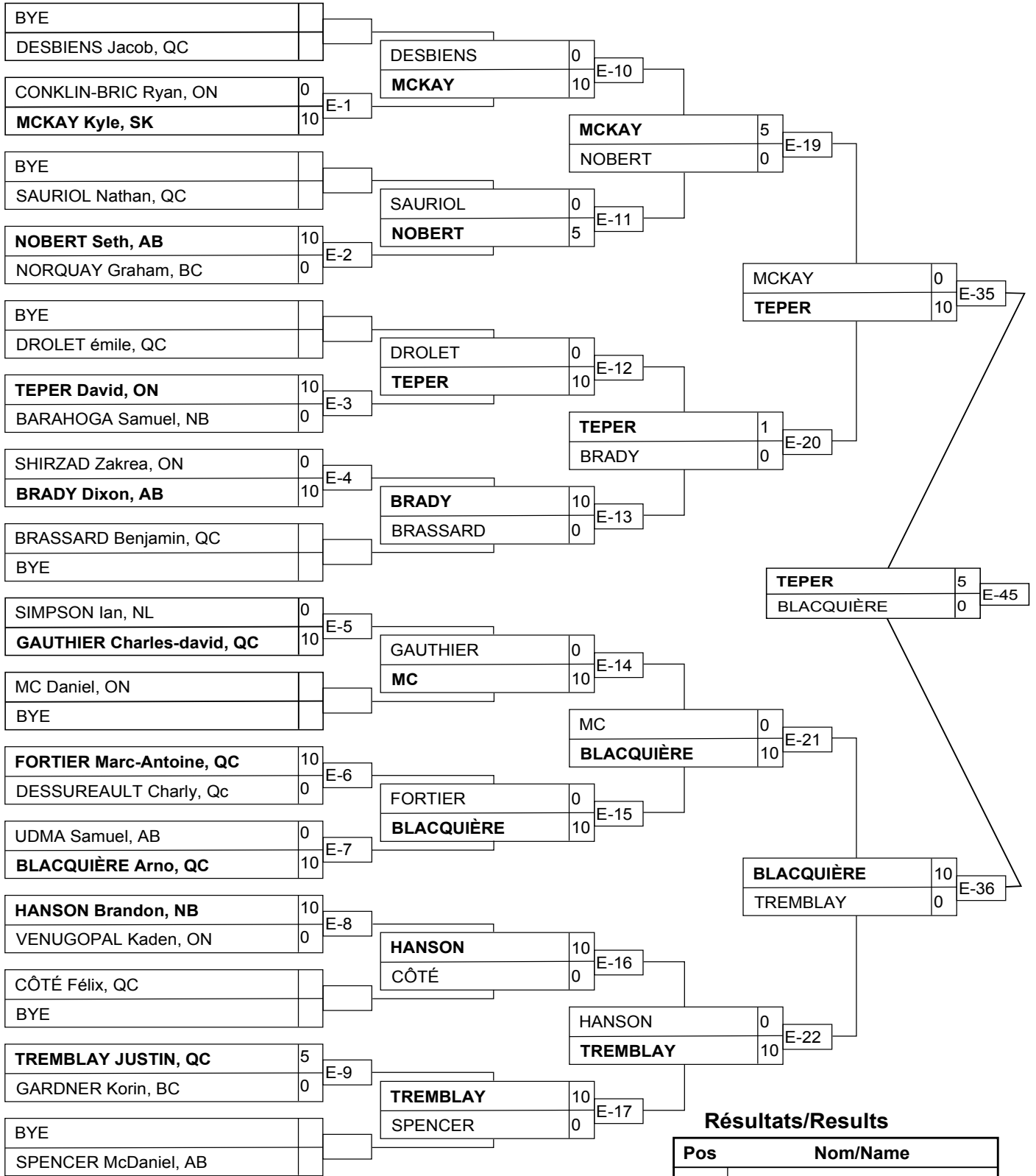

Résultats/Results

Pos	Nom/Name
1	TEPER David, ON
2	BLACQUIÈRE Arno, QC
3	MC Daniel, ON
3	TREMBLAY JUSTIN, QC

U18M -55

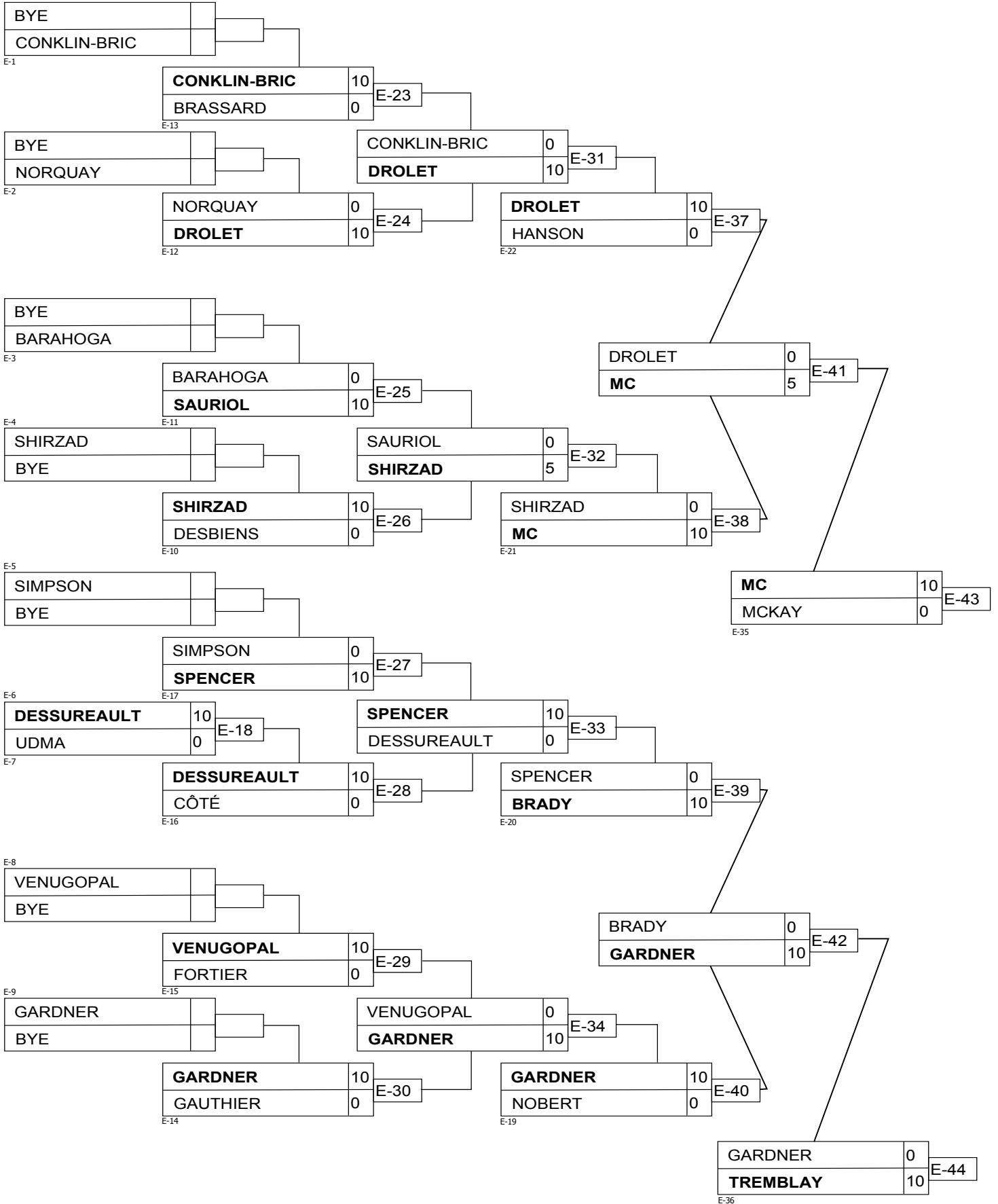

U18M -60

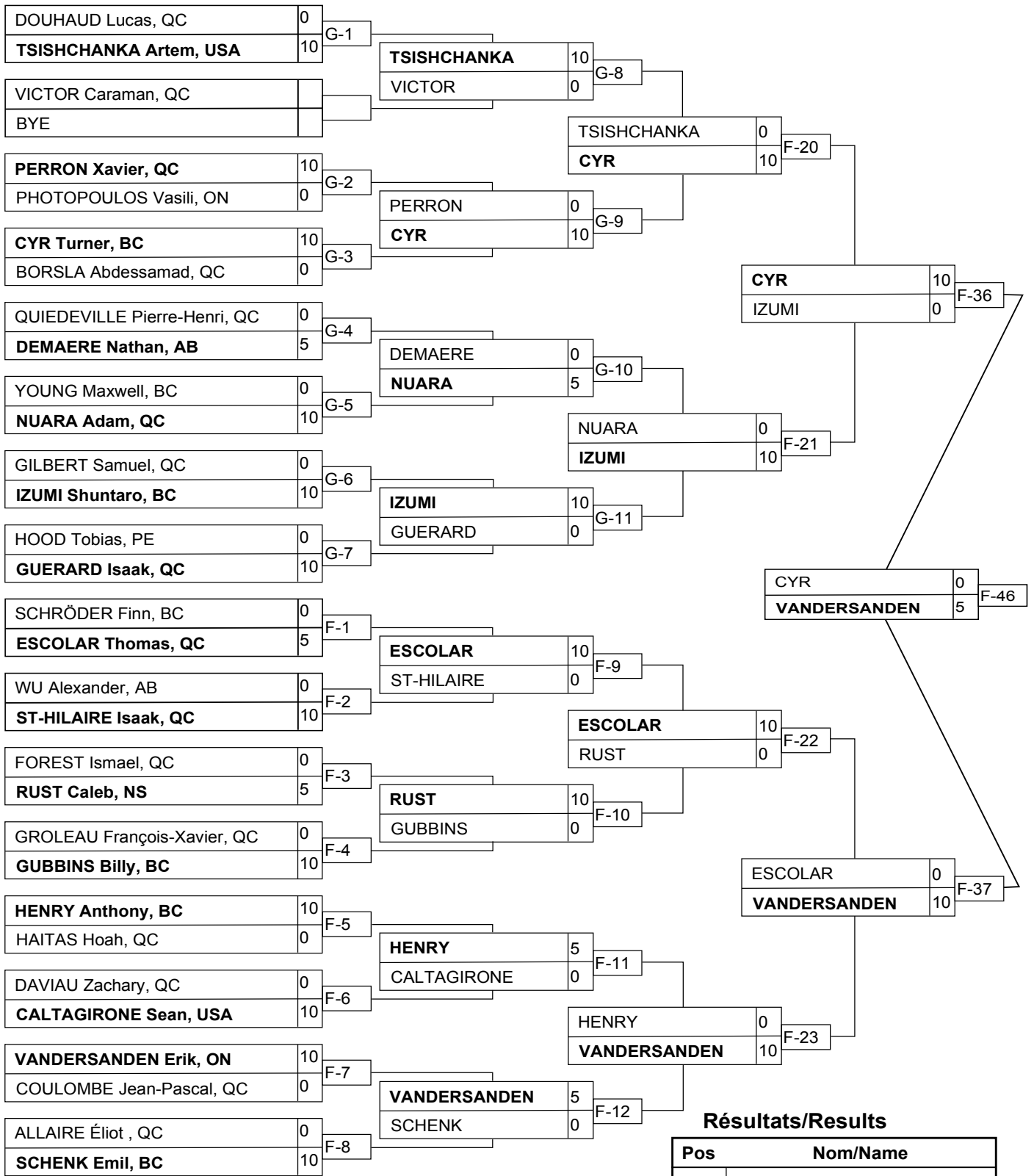

Résultats/Results

Pos	Nom/Name
1	VANDERSANDEN Erik, ON
2	CYR Turner, BC
3	HENRY Anthony, BC
3	SCHRÖDER Finn, BC

U18M -60

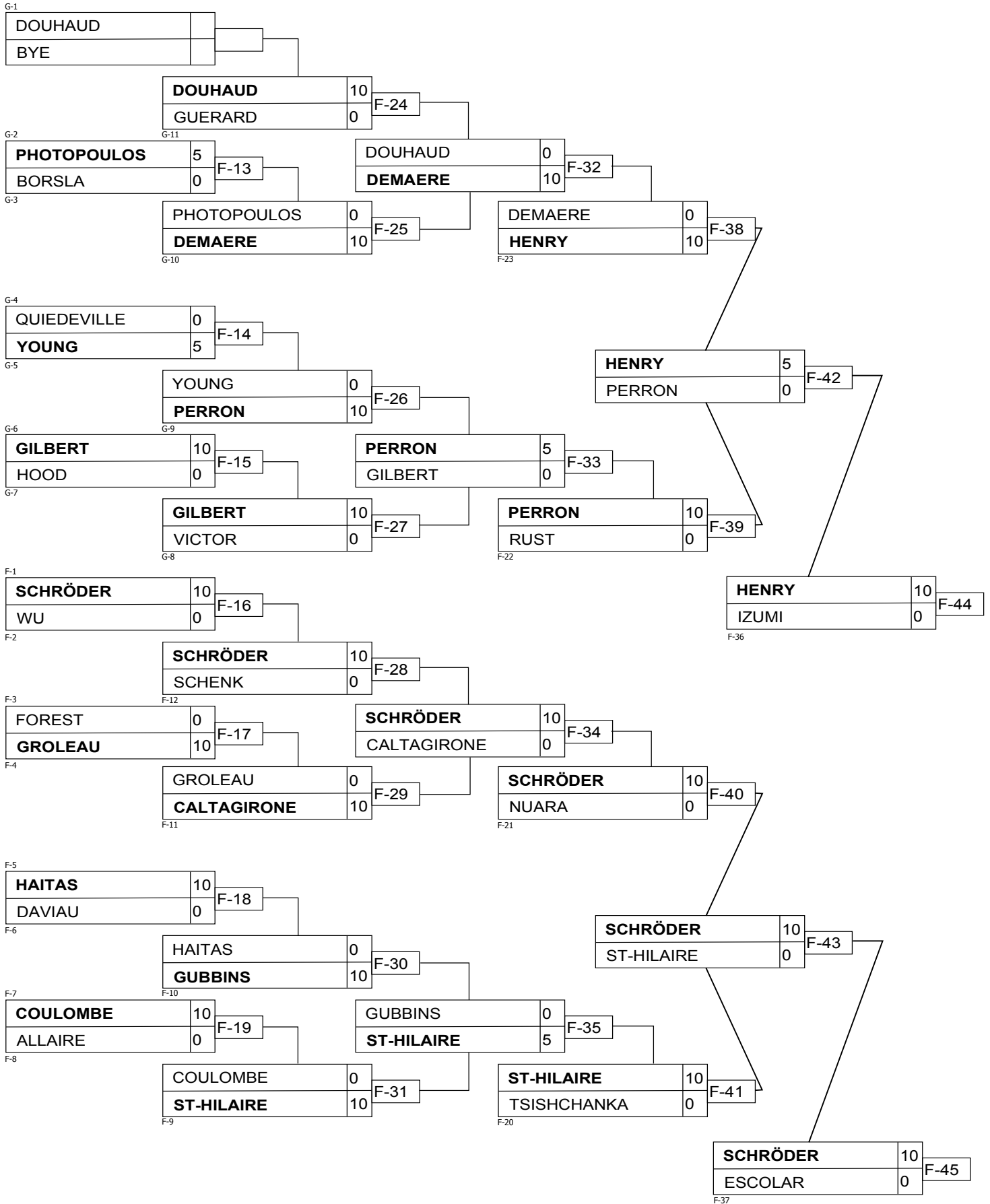

U18M -81

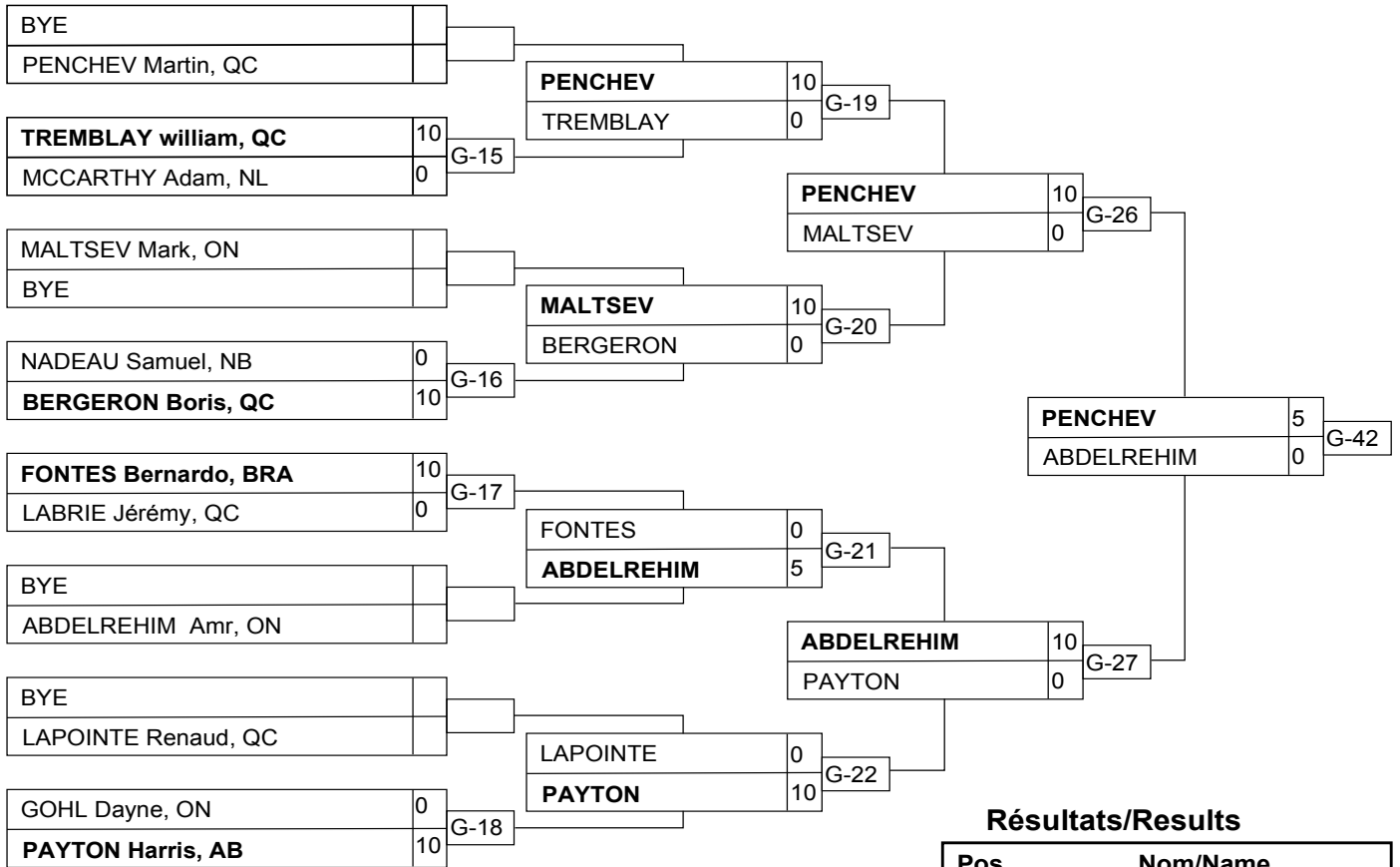

Résultats/Results

Pos	Nom/Name
1	PENCHEV Martin, QC
2	ABDELREHIM Amr, ON
3	MALTSEV Mark, ON
3	BERGERON Boris, QC

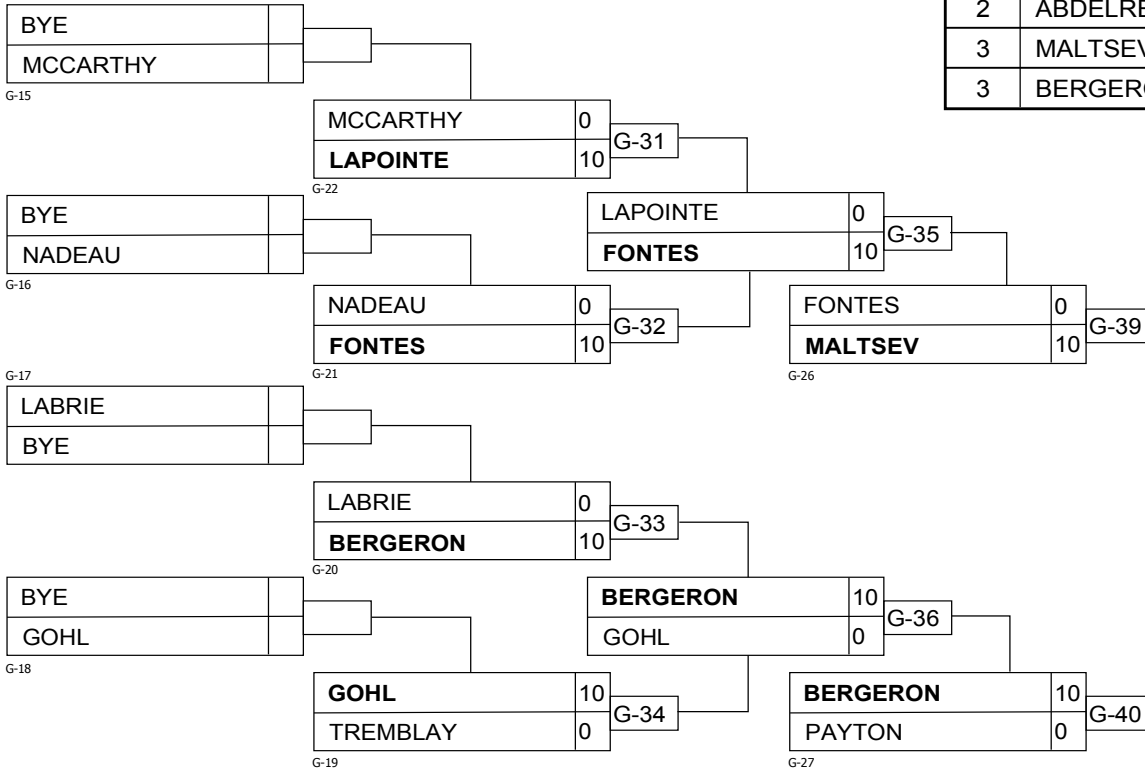

U18M +90

Compétiteurs/Competitors A

#	Nom/Name	Club	1	2	3	4	G/W	Pts	Pos
1	WHEATON Marcus	NB	XX				0	0	4
2	POPOV Simon	ON	10	XX	10	10	3	30	1
3	ABA Ramy	QC	10		XX	10	2	20	2
4	CHELFI Kevin	QC	5			XX	1	5	3

Matches/Matches A

Match	Blanc/White			Bleu/Blue	Rés/Res	Tmp/Tim	Code
G-12	WHEATON Marcus	1	2	POPOV Simon	0 - 10	0:44	IPO
G-13	ABA Ramy	3	4	CHELFI Kevin	10 - 0	1:57	IPO
G-23	WHEATON Marcus	1	3	ABA Ramy	0 - 10	0:38	IPO
G-24	POPOV Simon	2	4	CHELFI Kevin	10 - 0	0:30	IPO
G-28	WHEATON Marcus	1	4	CHELFI Kevin	0 - 5	4:00	WAZ
G-29	POPOV Simon	2	3	ABA Ramy	10 - 0	1:01	IPO

Compétiteurs/Competitors B

#	Nom/Name	Club	5	6	7	G/W	Pts	Pos
5	COUTU Xavier	QC	XX	10	10	2	20	1
6	HUDSON Jack	NL		XX		0	0	3
7	ELLIOT Wilson	NT		10	XX	1	10	2

Matches/Matches B

Match	Blanc/White			Bleu/Blue	Rés/Res	Tmp/Tim	Code
G-14	COUTU Xavier	5	6	HUDSON Jack	10 - 0	0:49	IPO
G-25	COUTU Xavier	5	7	ELLIOT Wilson	10 - 0	2:36	HAN
G-30	HUDSON Jack	6	7	ELLIOT Wilson	0 - 10	0:34	IPO

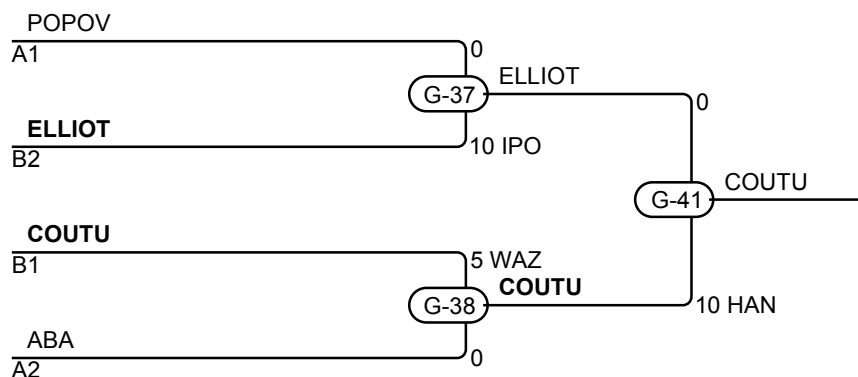

Résultats/Results

Pos	Nom/Name
1	COUTU Xavier, QC
2	ELLIOT Wilson, NT
3	POPOV Simon, ON
3	ABA Ramy, QC