

CDH 2016 15 octobre PEPS FO U16 -42

Competitors: 2

Competitors

#	Name	Grade	Club	1	2	Wins	Pts	Pos
1	BLOUIN GAMACHE Gael	2k	CVJR			0	0	2
2	LACHANCE Claude-André	2k	jjonquiere	10		1	10	1

Matches

Match	White			Blue	Result	Time	Code
1	BLOUIN GAMACHE Gael	1	2	LACHANCE Claude-André	0 - 10	0:00	IPO

Results

Pos	Name
1	LACHANCE Claude-André, jjonquiere
2	BLOUIN GAMACHE Gael, CVJR

CDH 2016 15 octobre PEPS FO U16 -60

Competitors: 2

Competitors

#	Name	Grade	Club	1	2	Wins	Pts	Pos
1	ZUZUNAGA Santiago	3k+	Perrot-Shima			0	0	2
2	DUTREMBLE Émilien	3k	St-Hyacinthe	10		1	10	1

Matches

Match	White			Blue	Result	Time	Code
1	ZUZUNAGA Santiago	1	2	DUTREMBLE Émilien	0 - 10	0:00	IPO

Results

Pos	Name
1	DUTREMBLE Émilien, St-Hyacinthe
2	ZUZUNAGA Santiago, Perrot-Shima

CDH 2016 15 octobre PEPS FO U16 -66

Competitors: 2

Competitors

#	Name	Grade	Club	1	2	Wins	Pts	Pos
1	GOUIN Michel	1k	Blainville		5	1	5	1
2	FORTIN Kyle	3k	Univestrie			0	0	2

Matches

Match	White			Blue	Result	Time	Code
1	GOUIN Michel	1	2	FORTIN Kyle	5 - 0	0:00	YUK

Results

Pos	Name
1	GOUIN Michel, Blainville
2	FORTIN Kyle, Univestrie

CDH 2016 15 octobre PEPS FO U16F -57

Competitors: 2

Competitors

#	Name	Grade	Club	1	2	Wins	Pts	Pos
1	ROUX Marianne	2k	St-Jean-Bosco		10	1	10	1
2	MANIL Cassandra	3k+	jjonquière			0	0	2

Matches

Match	White			Blue	Result	Time	Code
1	ROUX Marianne	1	2	MANIL Cassandra	10 - 0	0:00	IPO

Results

Pos	Name
1	ROUX Marianne, St-Jean-Bosco
2	MANIL Cassandra, jjonquière

CDH 2016 15 octobre PEPS FO U16M -55

Competitors: 2

Competitors

#	Name	Grade	Club	1	2	Wins	Pts	Pos
1	GILBERT Samuel	2k	Rikidokan			0	0	2
2	QUIEDVILLE Pierre Henri	1k	Vieille Capitale	10		1	10	1

Matches

Match	White			Blue	Result	Time	Code
1	GILBERT Samuel	1	2	QUIEDVILLE Pierre Henri	0 - 10	0:00	IPO

Results

Pos	Name
1	QUIEDVILLE Pierre Henri, Vieille Capitale
2	GILBERT Samuel, Rikidokan

CDH 2016 15 octobre PEPS U16F +70

Competitors: 2

Competitors

#	Name	Grade	Club	1	2	1	2	1	2	Wins	Pts	Pos
1	ARCHAMBAULT Audrey	2k+	Asbestos		10		10			2	20	1
2	DESBIENS Sara	3k	JSK Laterrière							0	0	2

Matches

Match	White			Blue	Result	Time	Code
A-18	ARCHAMBAULT Audrey	1	2	DESBIENS Sara	10 - 0	2:29	WIP
A-24	ARCHAMBAULT Audrey	1	2	DESBIENS Sara	10 - 0	1:51	IPO
A-32	ARCHAMBAULT Audrey	1	2	DESBIENS Sara			

Results

Pos	Name
1	ARCHAMBAULT Audrey, Asbestos
2	DESBIENS Sara, JSK Laterrière

CDH 2016 15 octobre PEPS U16F -44

Competitors: 2

Competitors

#	Name	Grade	Club	1	2	1	2	1	2	Wins	Pts	Pos
1	TURCOTTE Béatrice	3k	Varenes		5		10			2	15	1
2	FOREST Iana	2k+	Beauport							0	0	2

Matches

Match	White			Blue	Result	Time	Code
A-22	TURCOTTE Béatrice	1	2	FOREST Iana	5 - 0	3:00	YUK
A-30	TURCOTTE Béatrice	1	2	FOREST Iana	10 - 0	1:26	IPO
A-36	TURCOTTE Béatrice	1	2	FOREST Iana			

Results

Pos	Name
1	TURCOTTE Béatrice, Varenes
2	FOREST Iana, Beauport

CDH 2016 15 octobre PEPS U16F -48

Competitors: 2

Competitors

#	Name	Grade	Club	1	2	1	2	1	2	Wins	Pts	Pos
1	CÔTÉ Éléonore	2k	budokwai		10		10			2	20	1
2	MICHAUD-DUGUAY Naomi	3k	Sept-iles							0	0	2

Matches

Match	White			Blue	Result	Time	Code
A-21	CÔTÉ Éléonore	1	2	MICHAUD-DUGUAY Naomi	10 - 0	2:13	IPO
A-29	CÔTÉ Éléonore	1	2	MICHAUD-DUGUAY Naomi	10 - 0	1:00	IPO
A-35	CÔTÉ Éléonore	1	2	MICHAUD-DUGUAY Naomi			

Results

Pos	Name
1	CÔTÉ Éléonore, budokwai
2	MICHAUD-DUGUAY Naomi, Sept-iles

CDH 2016 15 octobre PEPS U16F -52

Competitors: 5

Competitors

#	Name	Grade	Club	1	2	3	4	5	Wins	Pts	Pos
1	PORLIER Léa	2k	Sept-iles			7	7	10	3	24	2
2	GRENIER Amélie	2k+	JSK Laterrière	10		10	10	10	4	40	1
3	TARDIF Annabelle	2k	To hakukan						0	0	5
4	LAROUCHE Amélie	2k	Sakura			10		10	2	20	3
5	SALVAS Florence	3k	Varenes			10			1	10	4

Matches

Match	White			Blue	Result	Time	Code
D-9	LAROUCHE Amélie	4	5	SALVAS Florence	10 - 0	0:33	IPO
D-10	PORLIER Léa	1	2	GRENIER Amélie	0 - 10	0:22	WIP
D-17	TARDIF Annabelle	3	4	LAROUCHE Amélie	0 - 10	0:55	IPO
D-18	PORLIER Léa	1	5	SALVAS Florence	10 - 0	1:10	WIP
D-25	GRENIER Amélie	2	3	TARDIF Annabelle	10 - 0	0:32	IPO
D-26	PORLIER Léa	1	4	LAROUCHE Amélie	7 - 0	3:00	WAZ
D-33	TARDIF Annabelle	3	5	SALVAS Florence	0 - 10	0:23	WIP
D-34	GRENIER Amélie	2	4	LAROUCHE Amélie	10 - 0	1:41	WIP
D-39	PORLIER Léa	1	3	TARDIF Annabelle	7 - 0	4:45	GSW
D-40	GRENIER Amélie	2	5	SALVAS Florence	10 - 0	0:03	IPO

Results

Pos	Name
1	GRENIER Amélie, JSK Laterrière
2	PORLIER Léa, Sept-iles
3	LAROUCHE Amélie, Sakura
4	SALVAS Florence, Varenes
5	TARDIF Annabelle, To hakukan

U16F -57

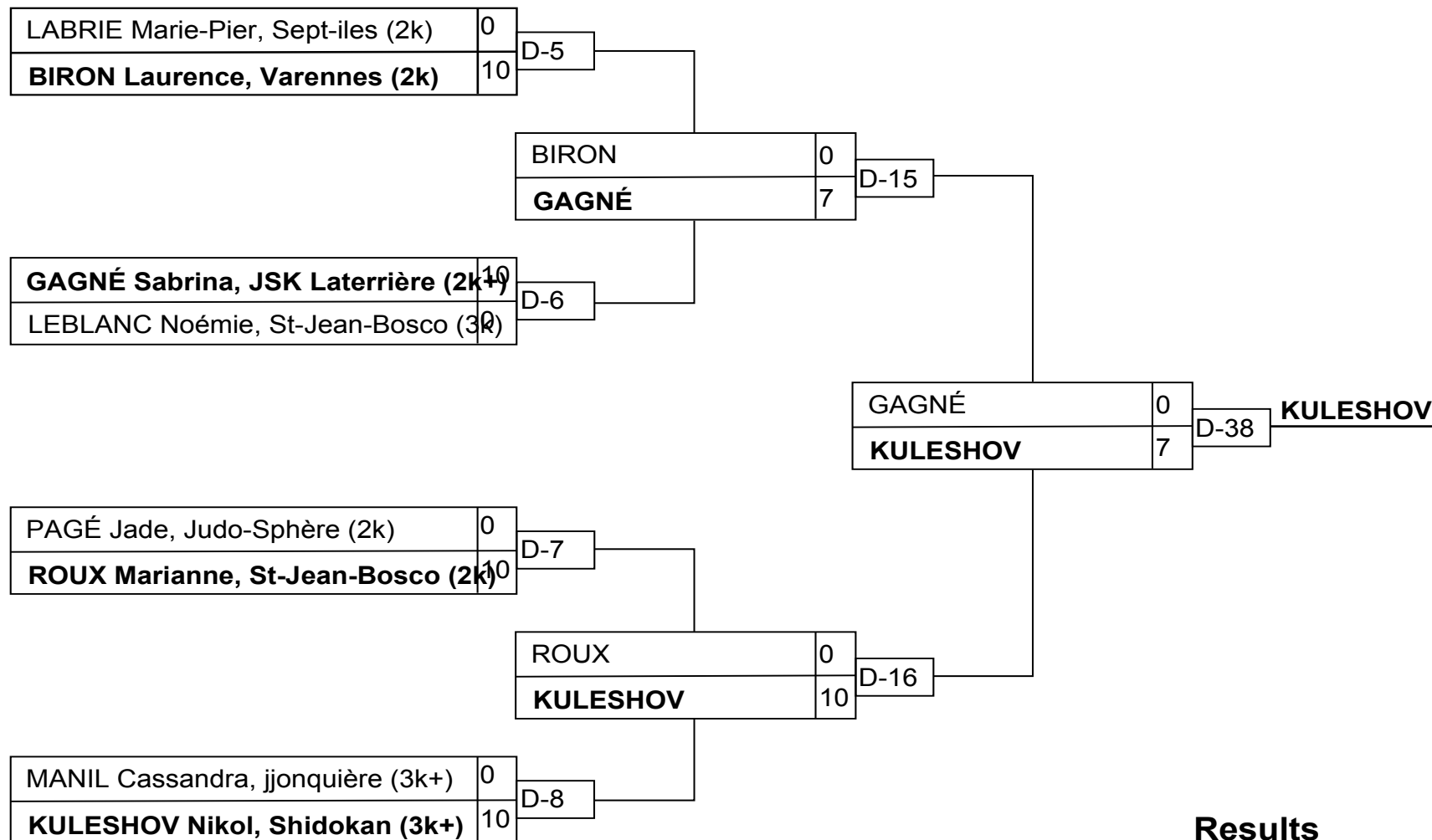

Results

Pos	Name
1	KULESHOV Nikol, Shidokan (3k+)
2	GAGNÉ Sabrina, JSK Laterrière (2k+)
3	MANIL Cassandra, jjonquière (3k+)
3	ROUX Marianne, St-Jean-Bosco (2k)

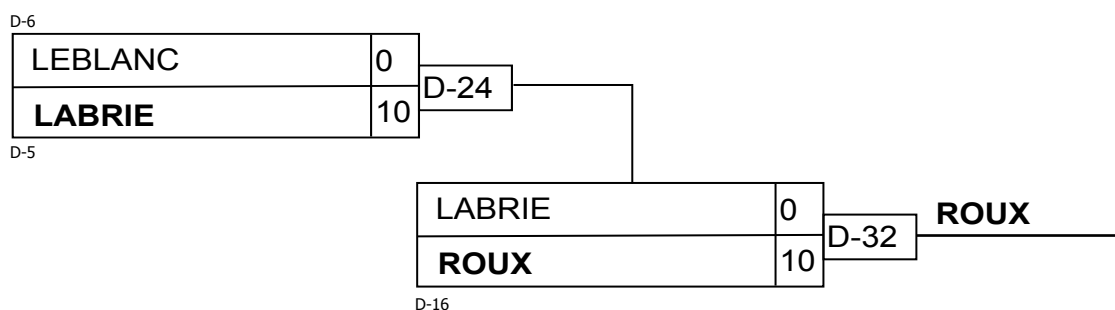
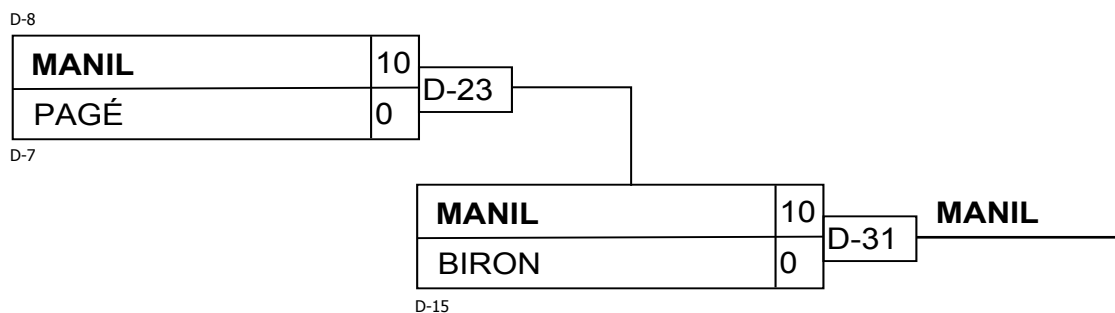

CDH 2016 15 octobre PEPS U16F -63

Competitors: 5

Competitors

#	Name	Grade	Club	1	2	3	4	5	Wins	Pts	Pos
1	GARNEAU Anne	3k	Lévis				10		1	10	4
2	RIOUX Karianne	3k	Zenshin	10			10		2	20	2
3	GÉLINAS Sara	2k	olympique	10	10		10	10	4	40	1
4	FONTAINE Shandra	2k	Kime-waza					10	1	10	5
5	PARADIS Laurence	3k	Judo tani	10	5				2	15	3

Matches

Match	White			Blue	Result	Time	Code
C-3	FONTAINE Shandra	4	5	PARADIS Laurence	10 - 0	1:02	IPO
C-4	GARNEAU Anne	1	2	RIOUX Karianne	0 - 10	2:38	WIP
C-7	GÉLINAS Sara	3	4	FONTAINE Shandra	10 - 0	0:26	WIP
C-8	GARNEAU Anne	1	5	PARADIS Laurence	0 - 10	1:16	WIP
C-14	RIOUX Karianne	2	3	GÉLINAS Sara	0 - 10	1:28	IPO
C-15	GARNEAU Anne	1	4	FONTAINE Shandra	10 - 0	1:50	IPO
C-19	GÉLINAS Sara	3	5	PARADIS Laurence	10 - 0	0:42	IPO
C-20	RIOUX Karianne	2	4	FONTAINE Shandra	10 - 0	0:38	IPO
C-26	GARNEAU Anne	1	3	GÉLINAS Sara	0 - 10	0:53	IPO
C-27	RIOUX Karianne	2	5	PARADIS Laurence	0 - 5	4:16	GSY

Results

Pos	Name
1	GÉLINAS Sara, olympique
2	RIOUX Karianne, Zenshin
3	PARADIS Laurence, Judo tani
4	GARNEAU Anne, Lévis
5	FONTAINE Shandra, Kime-waza

CDH 2016 15 octobre PEPS U16F -70

Competitors: 1

Competitors

#	Name	Grade	Club	1	Wins	Pts	Pos
1	CLOUTIER Alyson	3k	Seikidokan		0	0	1

Matches

Match	White	Blue	Result	Time	Code
-------	-------	------	--------	------	------

Results

Pos	Name
1	CLOUTIER Alyson, Seikidokan

CDH 2016 15 octobre PEPS U16M +73

Competitors: 2

Competitors

#	Name	Grade	Club	1	2	1	2	1	2	Wins	Pts	Pos
1	AUDET Jean-Sébastien	2k	la pocatière							0	0	2
2	ABA Rami	3k	St-Paul-l'ermite	10		10				2	20	1

Matches

Match	White			Blue	Result	Time	Code
A-17	AUDET Jean-Sébastien	1	2	ABA Rami	0 - 10	0:25	WIP
A-23	AUDET Jean-Sébastien	1	2	ABA Rami	0 - 10	0:00	FUS
A-31	AUDET Jean-Sébastien	1	2	ABA Rami			

Results

Pos	Name
1	ABA Rami, St-Paul-l'ermite
2	AUDET Jean-Sébastien, la pocatière

CDH 2016 15 octobre PEPS U16M -38

Competitors: 4

Competitors

#	Name	Grade	Club	1	2	3	4	Wins	Pts	Pos
1	BERTRAND Félix-Olivier	2k	st-jean-bosco		10	7	10	3	27	1
2	RIOUX Mavrick	3k	zenshin				10	1	10	3
3	PASSELANDE Mathieu	3k+	varenes		10		10	2	20	2
4	ROY Victor	3k	asbestos					0	0	4

Matches

Match	White			Blue	Result	Time	Code
B-15	BERTRAND Félix-Olivier	1	2	RIOUX Mavrick	10 - 0	0:47	WIP
B-16	PASSELANDE Mathieu	3	4	ROY Victor	10 - 0	0:19	IPO
B-23	BERTRAND Félix-Olivier	1	3	PASSELANDE Mathieu	7 - 0	3:00	WAZ
B-24	RIOUX Mavrick	2	4	ROY Victor	10 - 0	0:20	IPO
B-27	BERTRAND Félix-Olivier	1	4	ROY Victor	10 - 0	1:07	IPO
B-28	RIOUX Mavrick	2	3	PASSELANDE Mathieu	0 - 10	1:09	IPO

Results

Pos	Name
1	BERTRAND Félix-Olivier, st-jean-bosco
2	PASSELANDE Mathieu, varenes
3	RIOUX Mavrick, zenshin
4	ROY Victor, asbestos

U16M -42

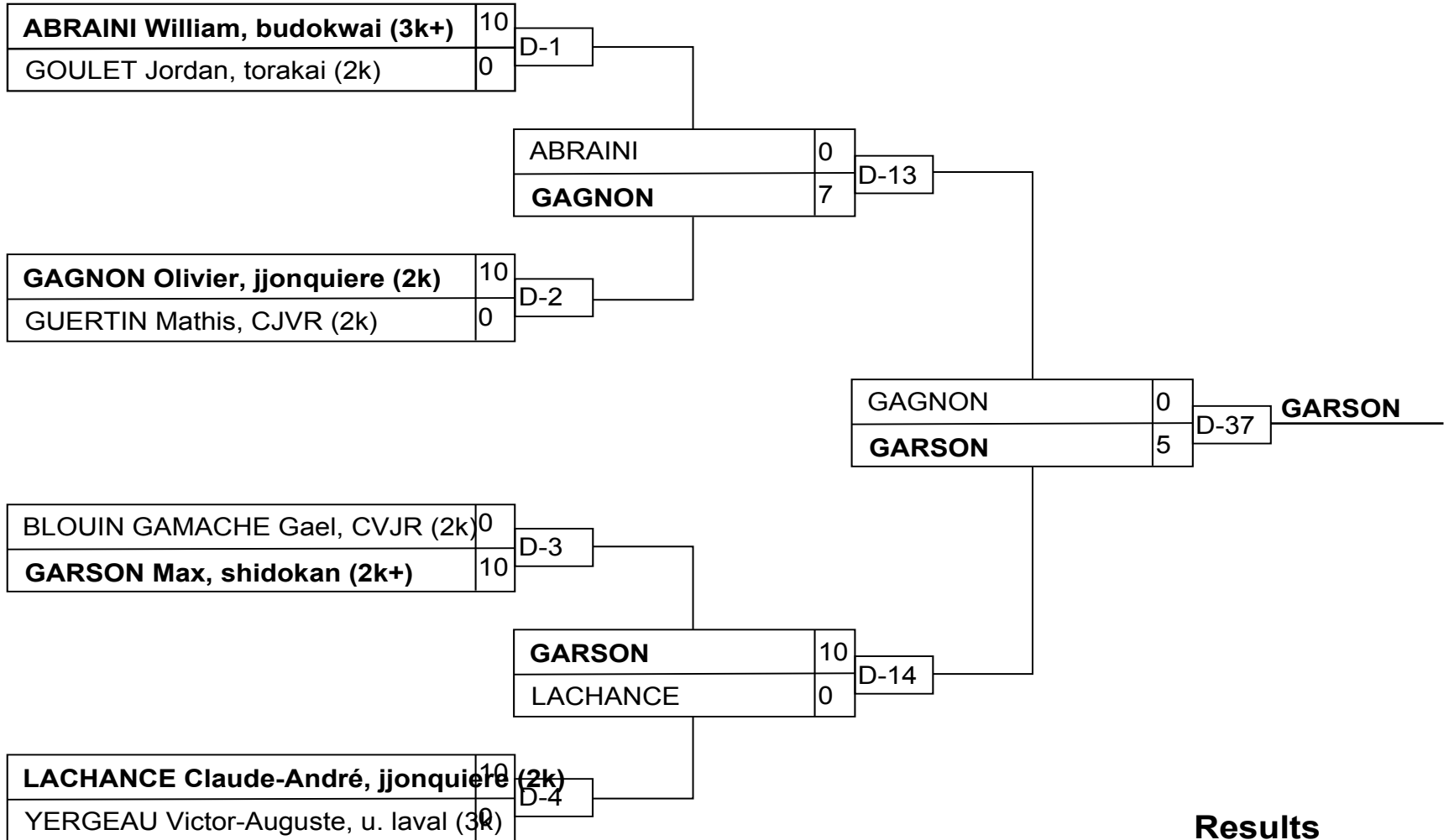

Results

Pos	Name
1	GARSON Max, shidokan (2k+)
2	GAGNON Olivier, jjonquiere (2k)
3	BLOUIN GAMACHE Gael, CVJR (2k)
3	LACHANCE Claude-André, jjonquiere (2k)

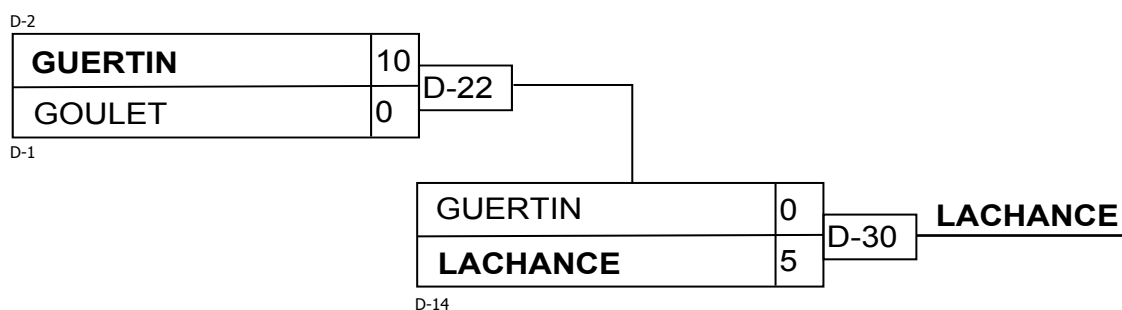
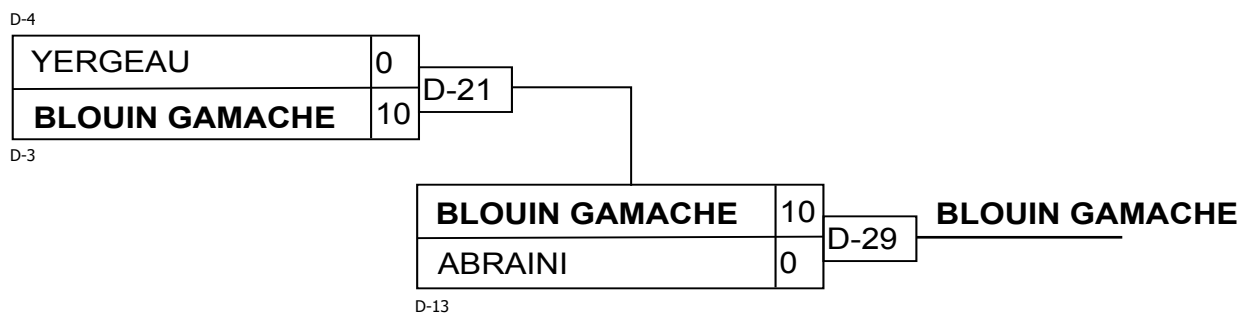

U16M -46

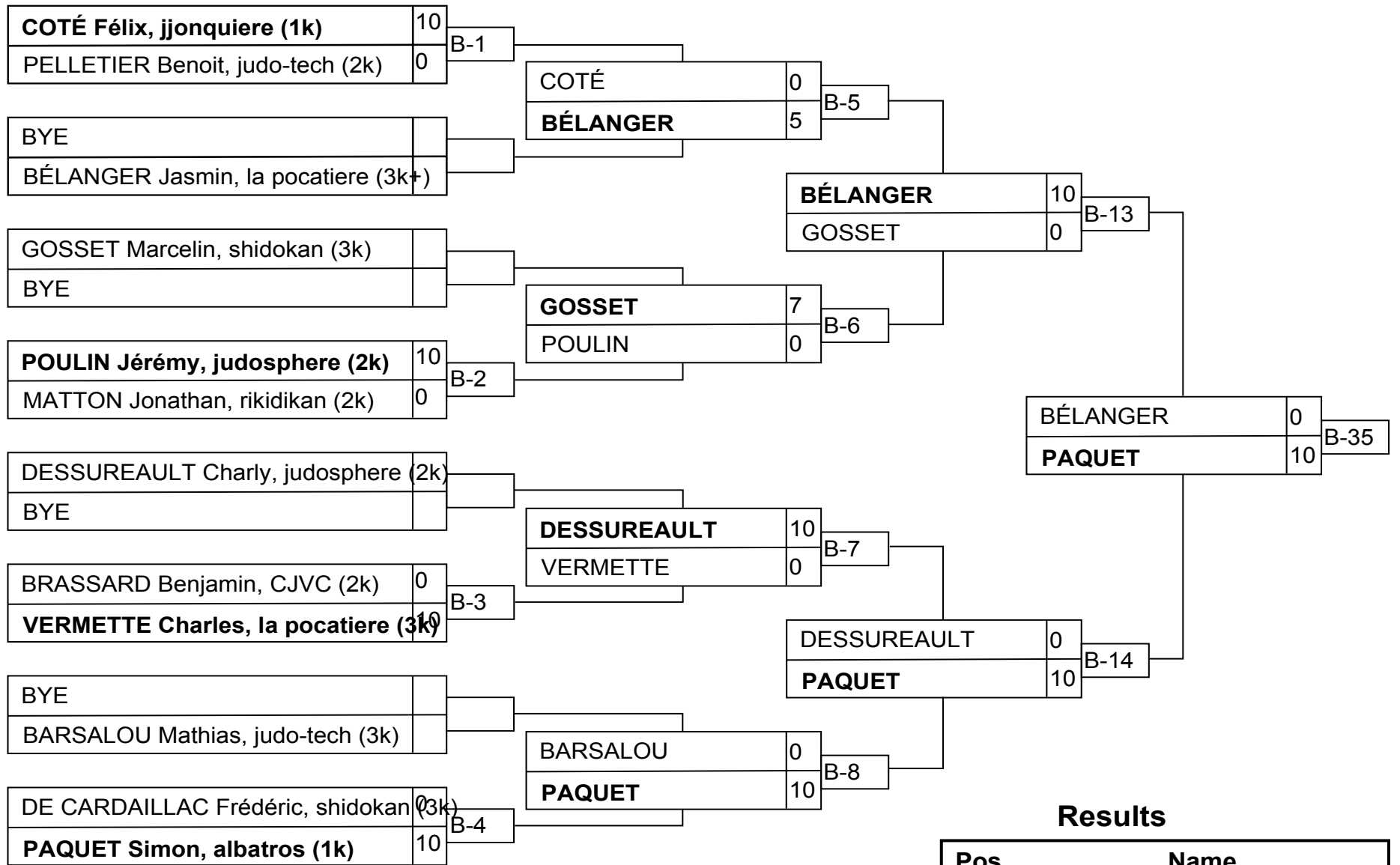

Results

Pos	Name
1	PAQUET Simon, albatros (1k)
2	BÉLANGER Jasmin, la pocatiere (3k+)
3	VERMETTE Charles, la pocatiere (3k)
3	DESSUREAULT Charly, judosphere (2k)

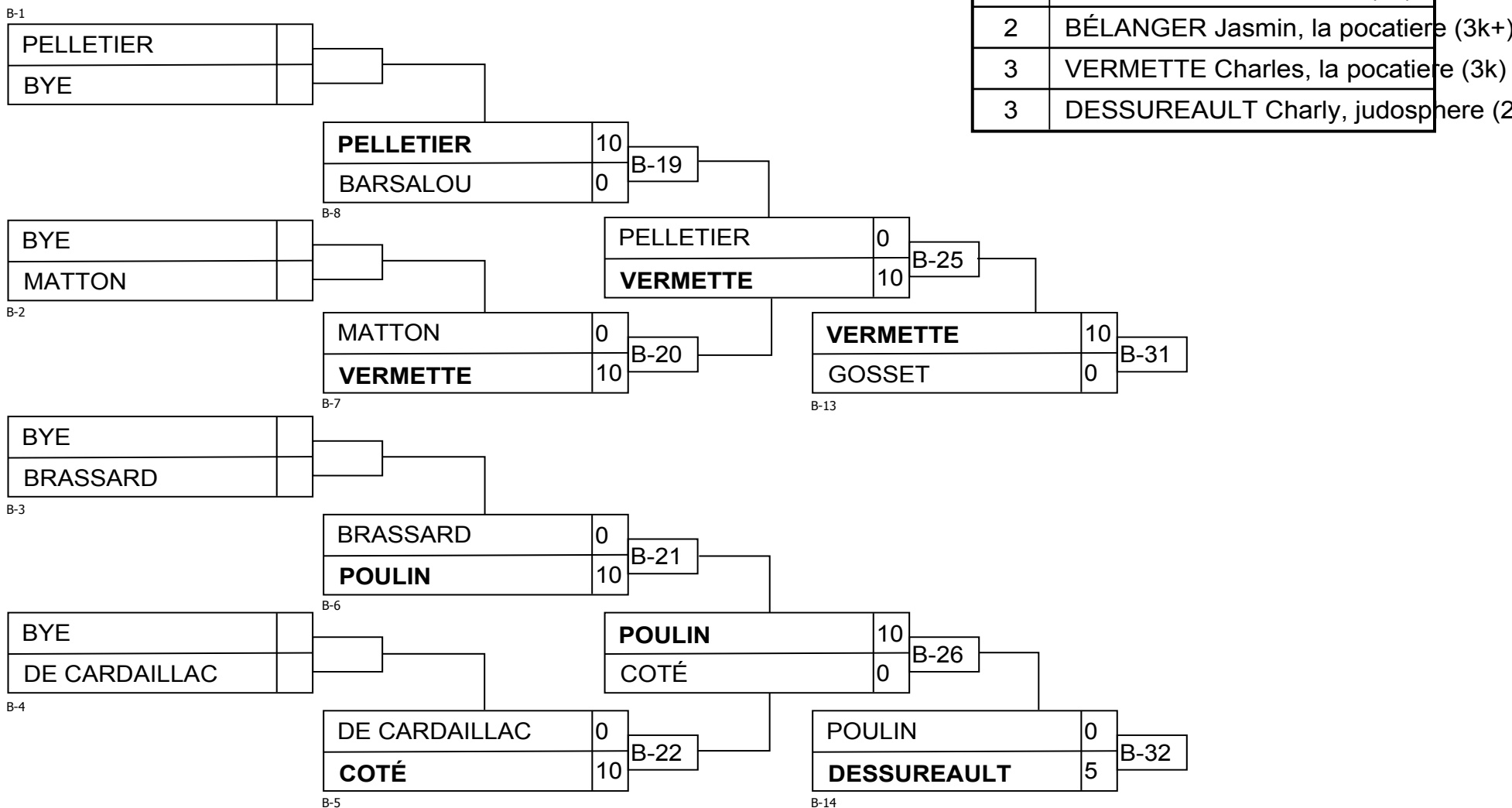

CDH 2016 15 octobre PEPS U16M -50

Competitors: 7

Competitors A

#	Name	Grade	Club	1	2	3	4	Wins	Pts	Pos
1	THIBODEAU Philippe	2k	blainville		10	1	10	3	21	1
2	DESROSIERS Nicolas	3k	st-hyacinthe					0	0	4
3	ALVAN ARENCIBIA Madai	3k	shidokan		10		10	2	20	2
4	LEMIRE Justin	3k	tohakukan		10			1	10	3

Matches A

Match	White	Blue	Result	Time	Code
C-9	THIBODEAU Philippe 1 2	DESROSIERS Nicolas	10 - 0	0:28	WIP
C-10	ALVAN ARENCIBIA Madai 3 4	LEMIRE Justin	10 - 0	0:12	IPO
C-16	THIBODEAU Philippe 1 3	ALVAN ARENCIBIA Madai	1 - 0	3:00	YUS
C-17	DESROSIERS Nicolas 2 4	LEMIRE Justin	0 - 10	1:36	IPO
C-21	THIBODEAU Philippe 1 4	LEMIRE Justin	10 - 0	1:23	WIP
C-22	DESROSIERS Nicolas 2 3	ALVAN ARENCIBIA Madai	0 - 10	2:16	WIP

Competitors B

#	Name	Grade	Club	5	6	7	Wins	Pts	Pos
5	LABRIE Cedric	2k	tohakukan		10		1	10	2
6	ABRAINI John	3k+	budokwai				0	0	3
7	LAMBERT Jason	3k	shawinigan	10	10		2	20	1

Matches B

Match	White	Blue	Result	Time	Code
C-11	LABRIE Cedric 5 6	ABRAINI John	10 - 0	0:36	IPO
C-18	LABRIE Cedric 5 7	LAMBERT Jason	0 - 10	0:10	HAN
C-23	ABRAINI John 6 7	LAMBERT Jason	0 - 10	1:40	HAN

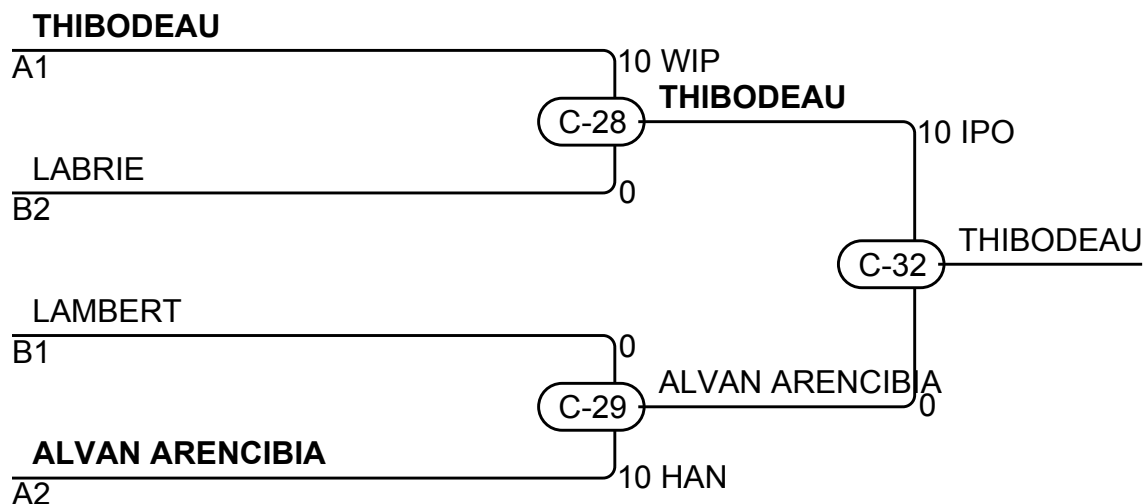

Results

Pos	Name
1	THIBODEAU Philippe, blainville
2	ALVAN ARENCIBIA Madai, shidokan
3	LABRIE Cedric, tohakukan
3	LAMBERT Jason, shawinigan

U16M -55

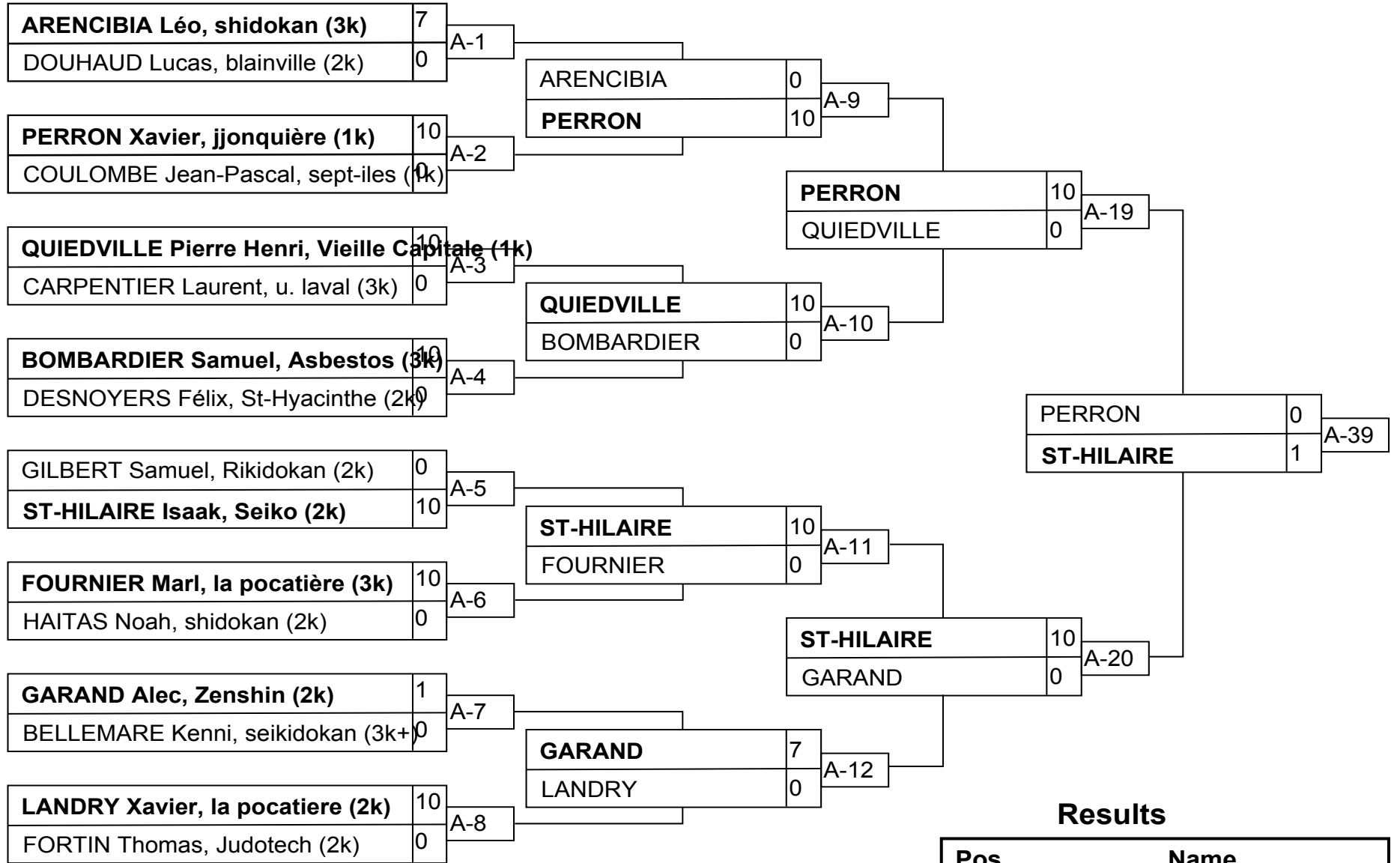

Results

Pos	Name
1	ST-HILAIRE Isaak, Seiko (2k)
2	PERRON Xavier, jjonquière (1k)
3	QUIEDVILLE Pierre Henri, Vieille Capitale (1k)
3	GILBERT Samuel, Rikidokan (2k)

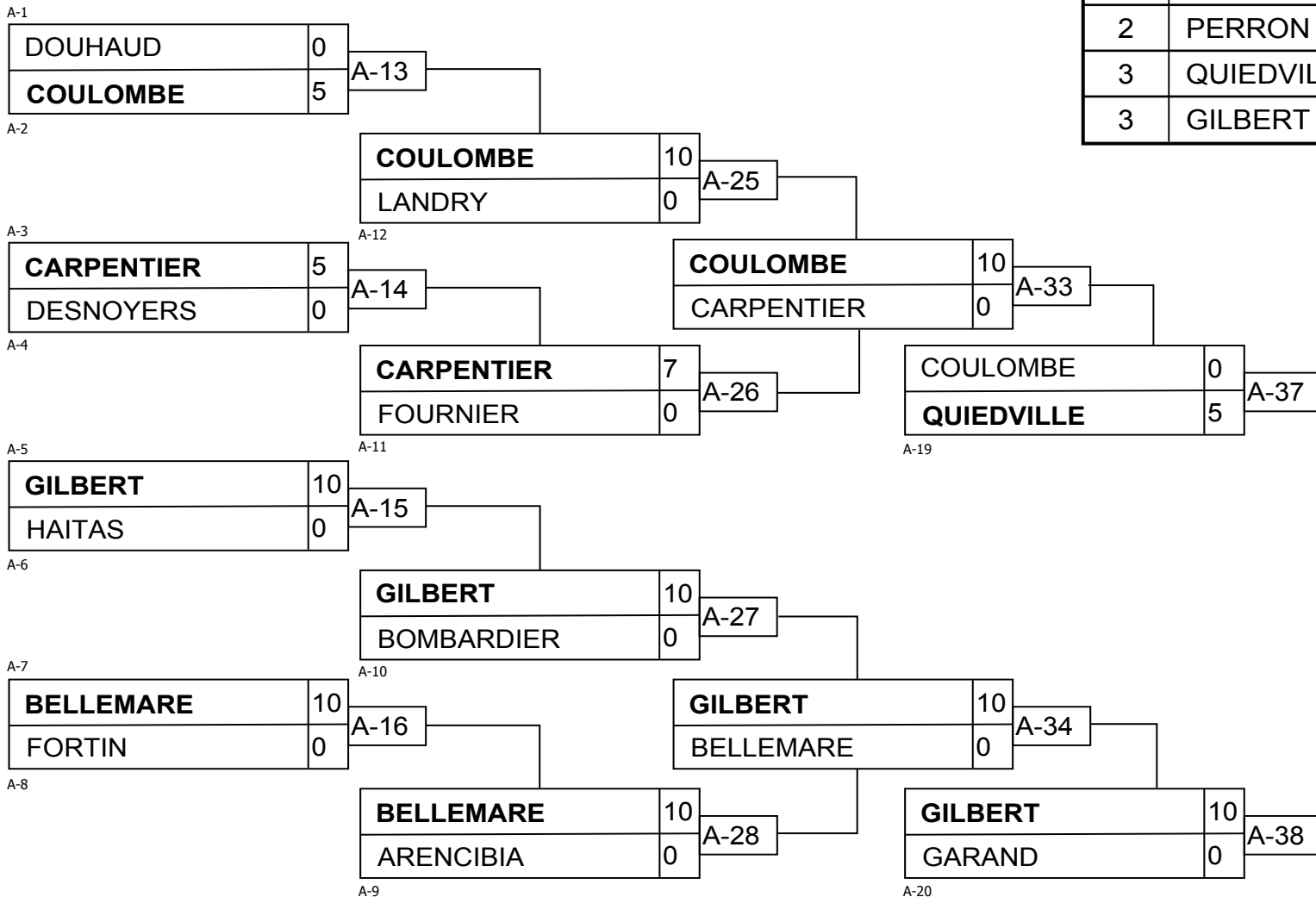

U16M -60

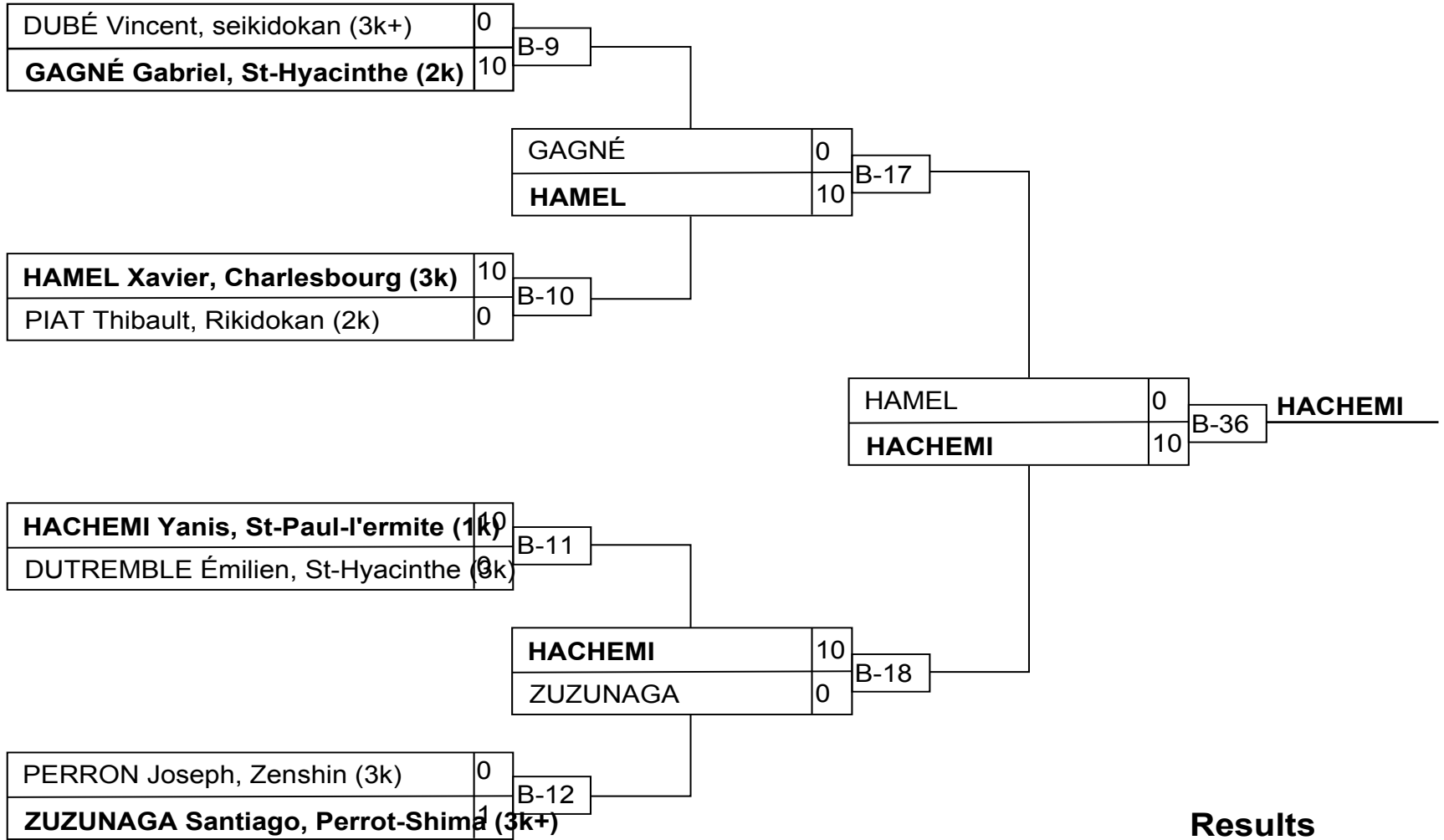

Results

Pos	Name
1	HACHEMI Yanis, St-Paul-l'ermite (1k)
2	HAMEL Xavier, Charlesbourg (3k)
3	DUTREMBLE Émilien, St-Hyacinthe
3	ZUZUNAGA Santiago, Perrot-Shima

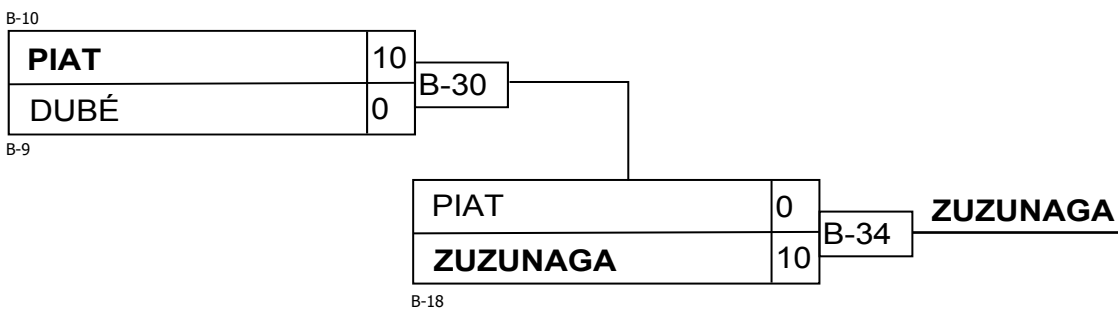
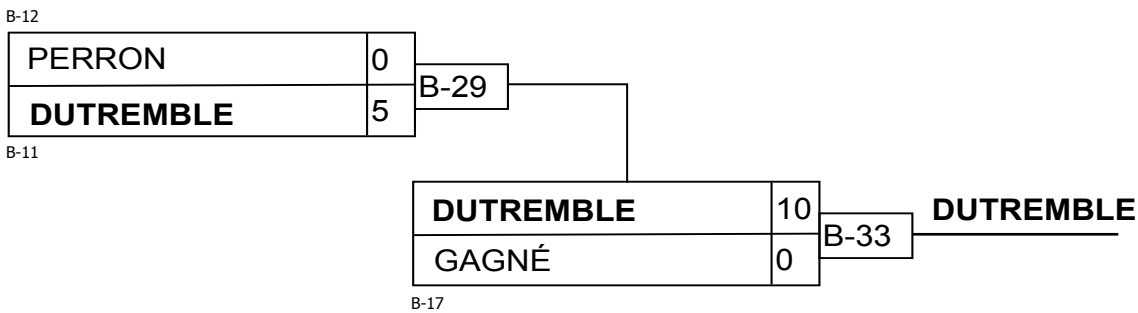

U16M -66

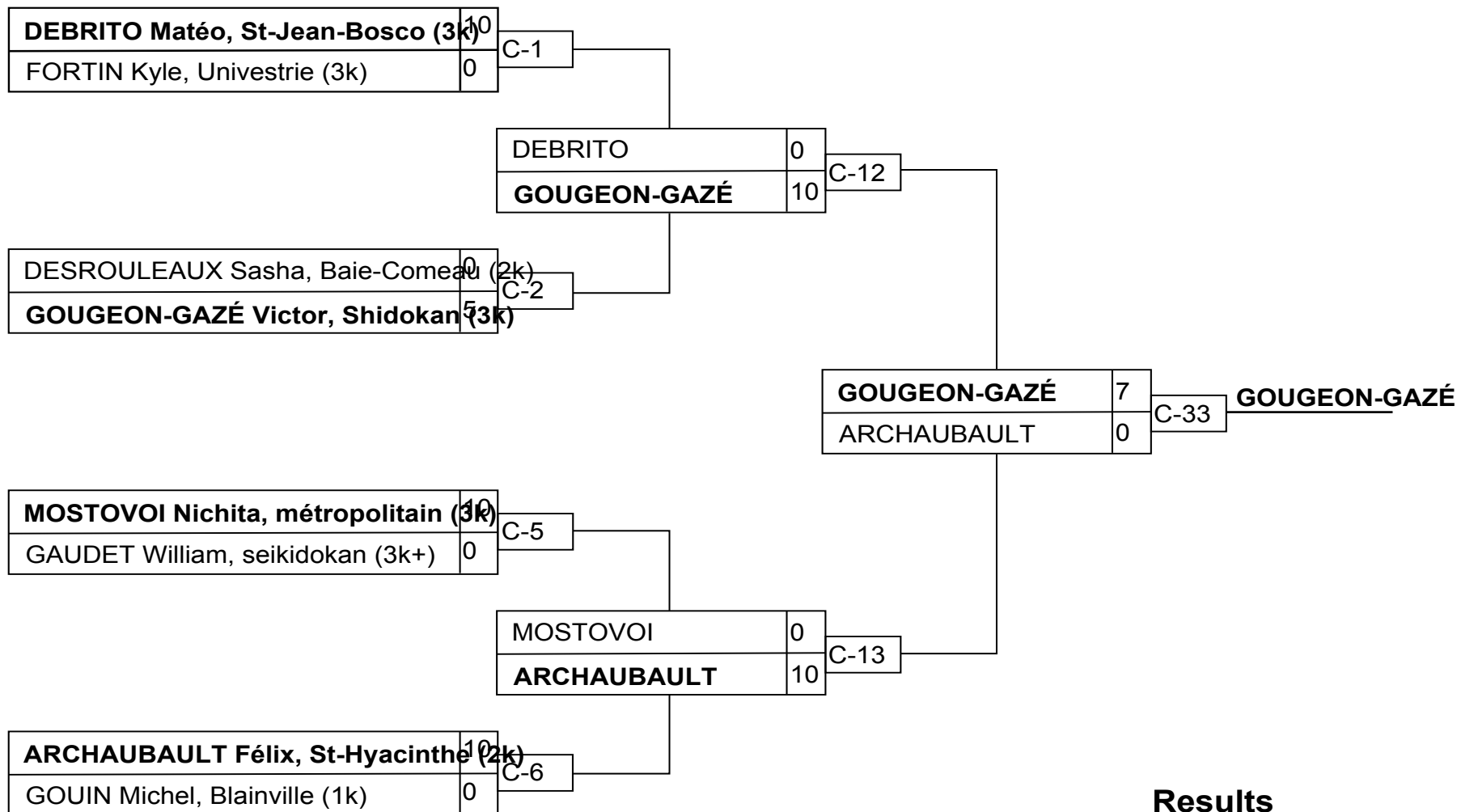

Results

Pos	Name
1	GOUGEON-GAZÉ Victor, Shidokan (3k)
2	ARCHAUBAULT Félix, St-Hyacinthe (2k)
3	GOUIN Michel, Blainville (1k)
3	FORTIN Kyle, Univestrie (3k)

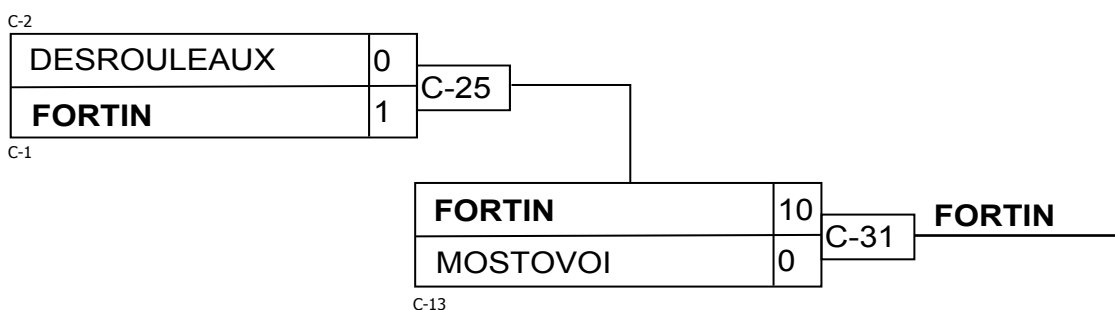
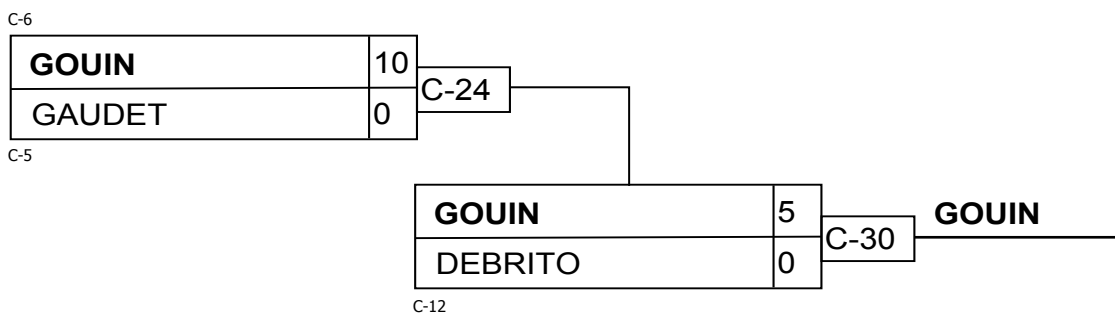

CDH 2016 15 octobre PEPS U16M -73

Competitors: 5

Competitors

#	Name	Grade	Club	1	2	3	4	5	Wins	Pts	Pos
1	BOUTIN Alexis	3k	St-Jean-Bosco					10	1	10	4
2	LABRIE Jeremiy	1k	Sept-iles	10		10	10	10	4	40	1
3	LAPointe Renaud	2k+	jjonquière	10			10	10	3	30	2
4	COTÉ Félix	2k	Albatros	7				10	2	17	3
5	ROY Jim	3k	CJVC						0	0	5

Matches

Match	White			Blue	Result	Time	Code
D-11	COTÉ Félix	4	5	ROY Jim	10 - 0	0:08	IPO
D-12	BOUTIN Alexis	1	2	LABRIE Jeremiy	0 - 10	0:41	WIP
D-19	LAPointe Renaud	3	4	COTÉ Félix	10 - 0	1:30	IPO
D-20	BOUTIN Alexis	1	5	ROY Jim	10 - 0	0:51	IPO
D-27	LABRIE Jeremiy	2	3	LAPointe Renaud	10 - 0	1:04	WIP
D-28	BOUTIN Alexis	1	4	COTÉ Félix	0 - 7	3:00	WAZ
D-35	LAPointe Renaud	3	5	ROY Jim	10 - 0	0:11	IPO
D-36	LABRIE Jeremiy	2	4	COTÉ Félix	10 - 0	0:26	IPO
D-41	BOUTIN Alexis	1	3	LAPointe Renaud	0 - 10	2:26	HAN
D-42	LABRIE Jeremiy	2	5	ROY Jim	10 - 0	0:08	IPO

Results

Pos	Name
1	LABRIE Jeremiy, Sept-iles
2	LAPointe Renaud, jjonquière
3	COTÉ Félix, Albatros
4	BOUTIN Alexis, St-Jean-Bosco
5	ROY Jim, CJVC