

# U16F -44 kg

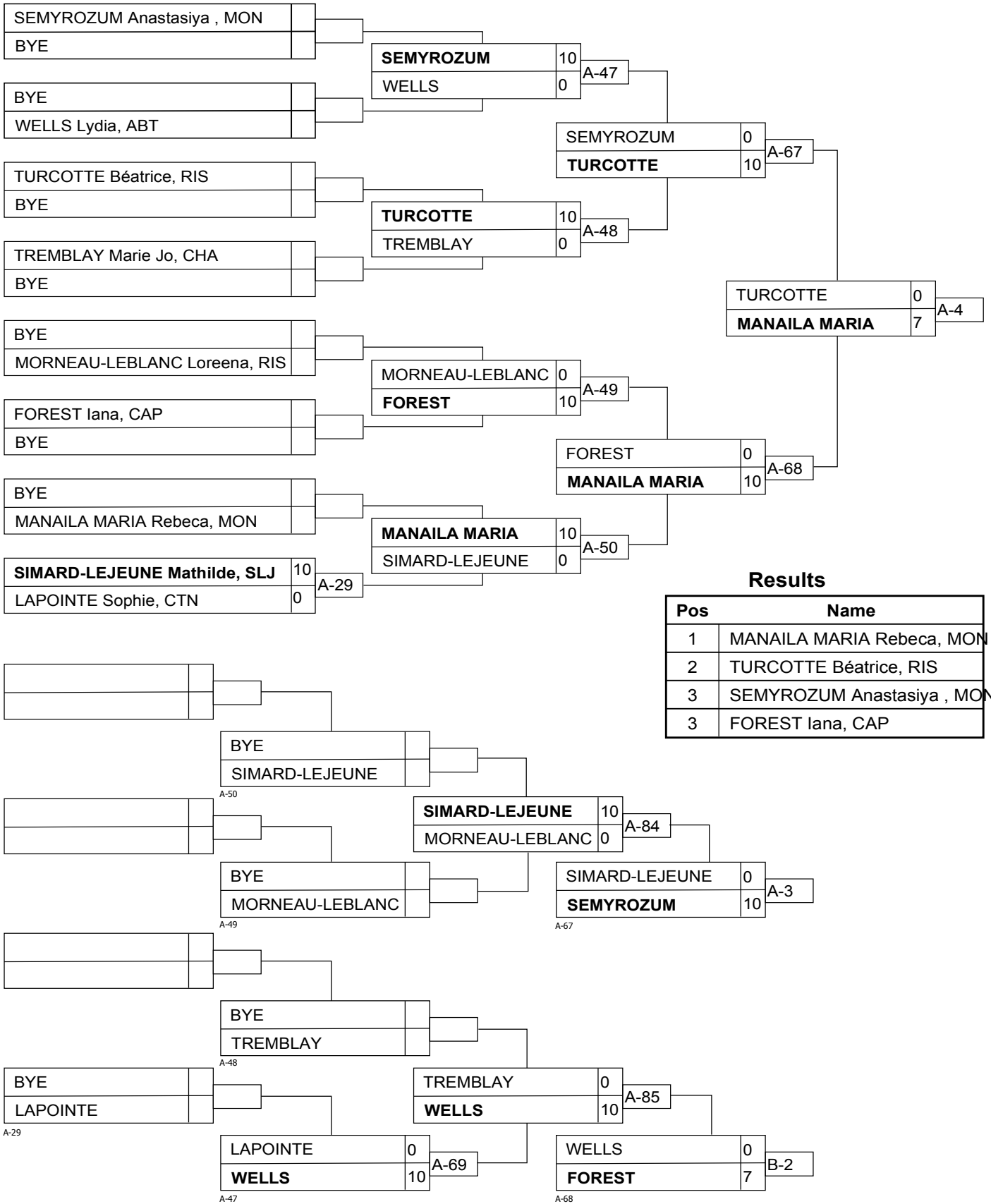

# U16F -48 kg

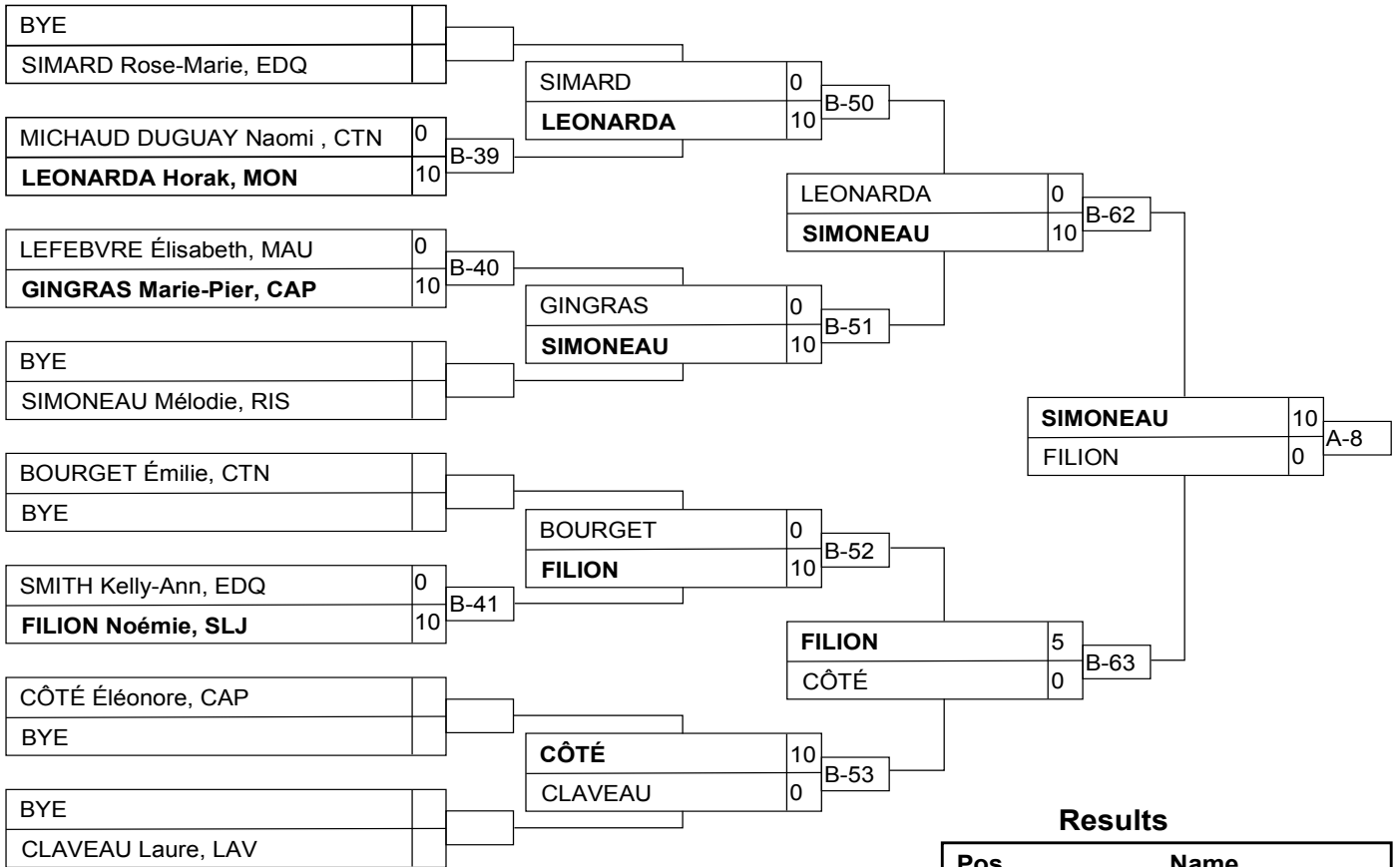

## Results

Pos	Name
1	SIMONEAU Mélodie, RIS
2	FILION Noémie, SLJ
3	LEONARDA Horak, MON
3	GINGRAS Marie-Pier, CAP

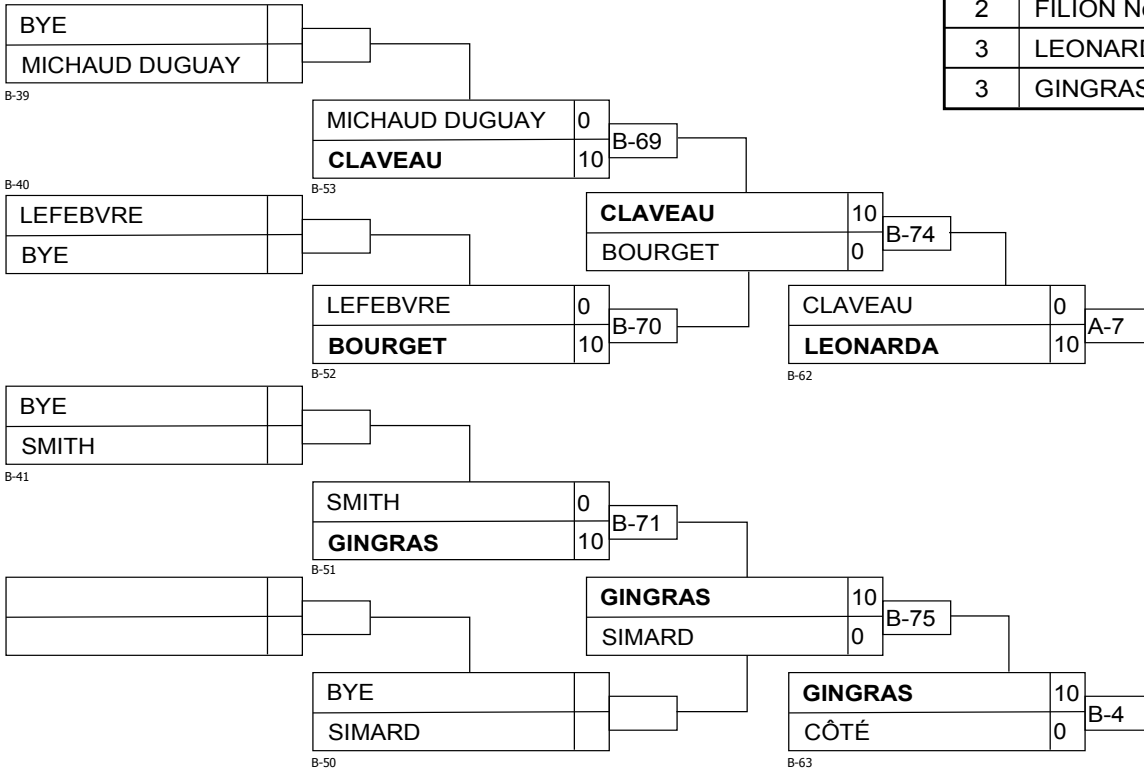

# U16F -52 kg

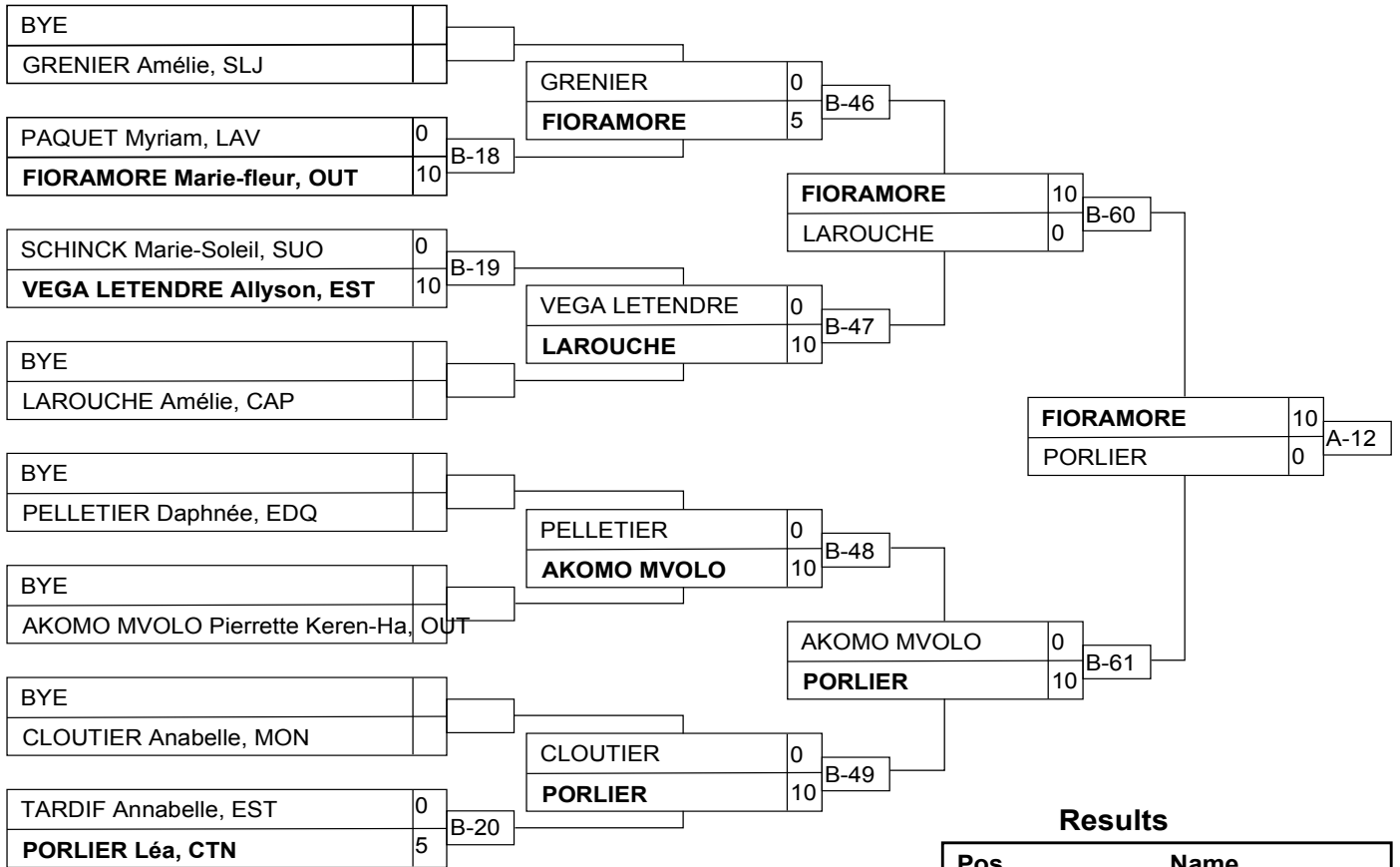

## Results

Pos	Name
1	FIORAMORE Marie-fleur, OUT
2	PORLIER Léa, CTN
3	LAROUCHE Amélie, CAP
3	GRENIER Amélie, SLJ

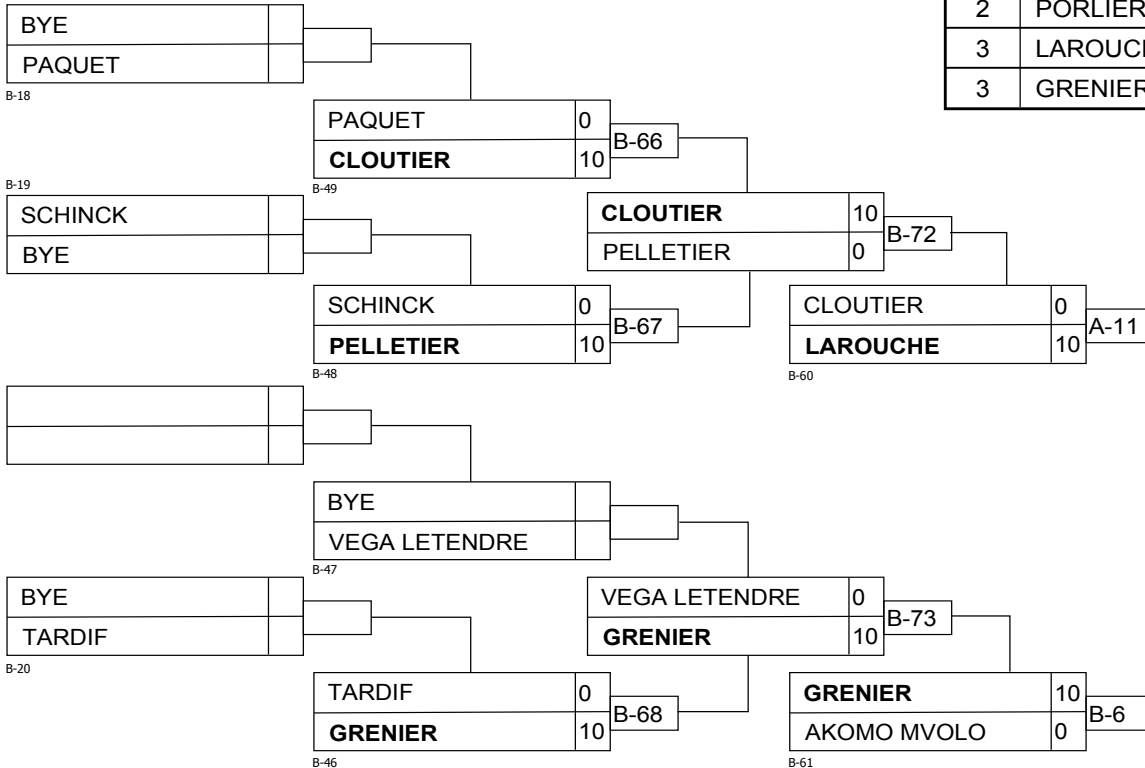

# U16M -42 kg

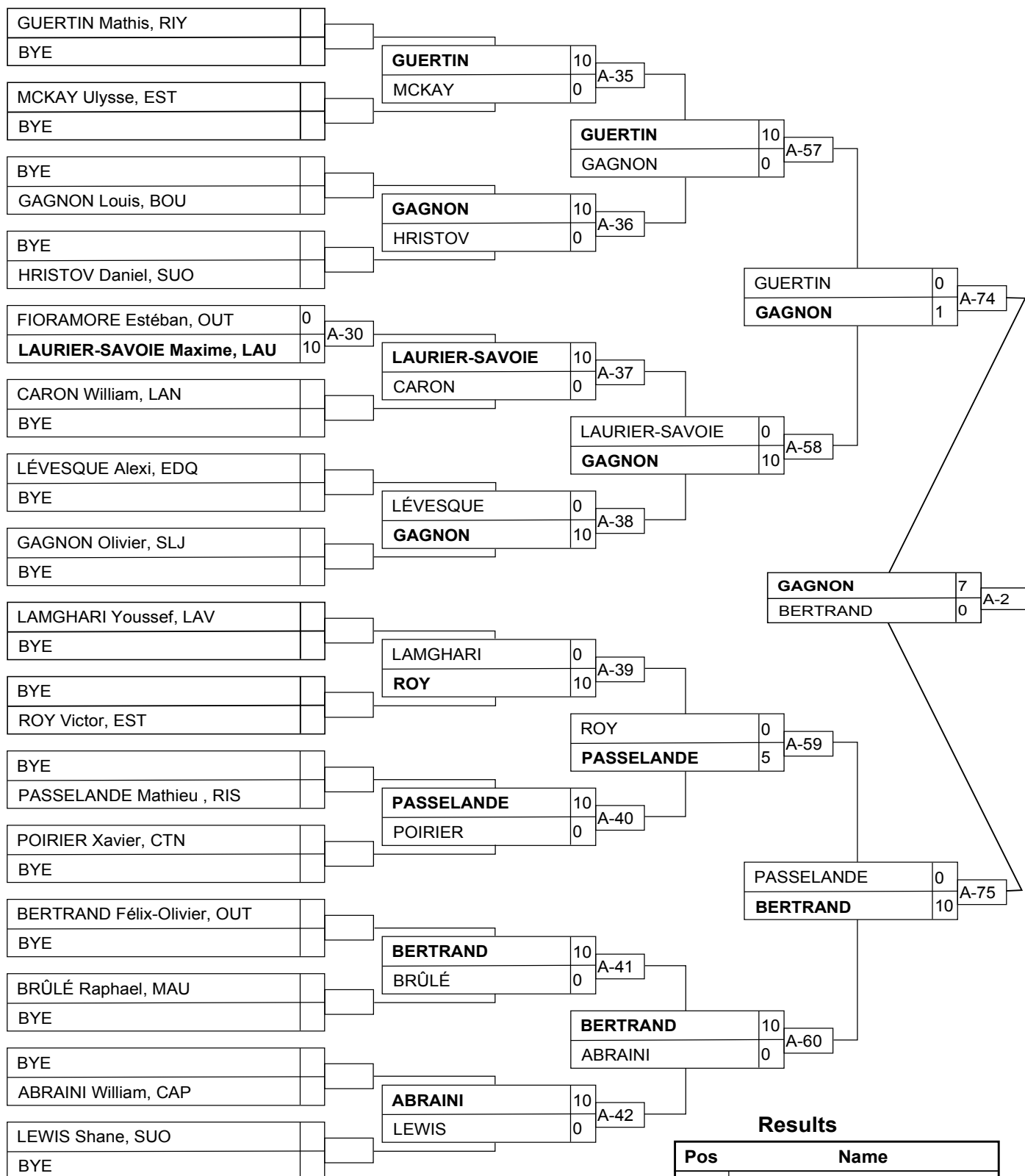

## Results

Pos	Name
1	GAGNON Olivier, SLJ
2	BERTRAND Félix-Olivier, OUT
3	GUERTIN Mathis, RIY
3	PASSELANDE Mathieu, RIS

# U16M -42 kg

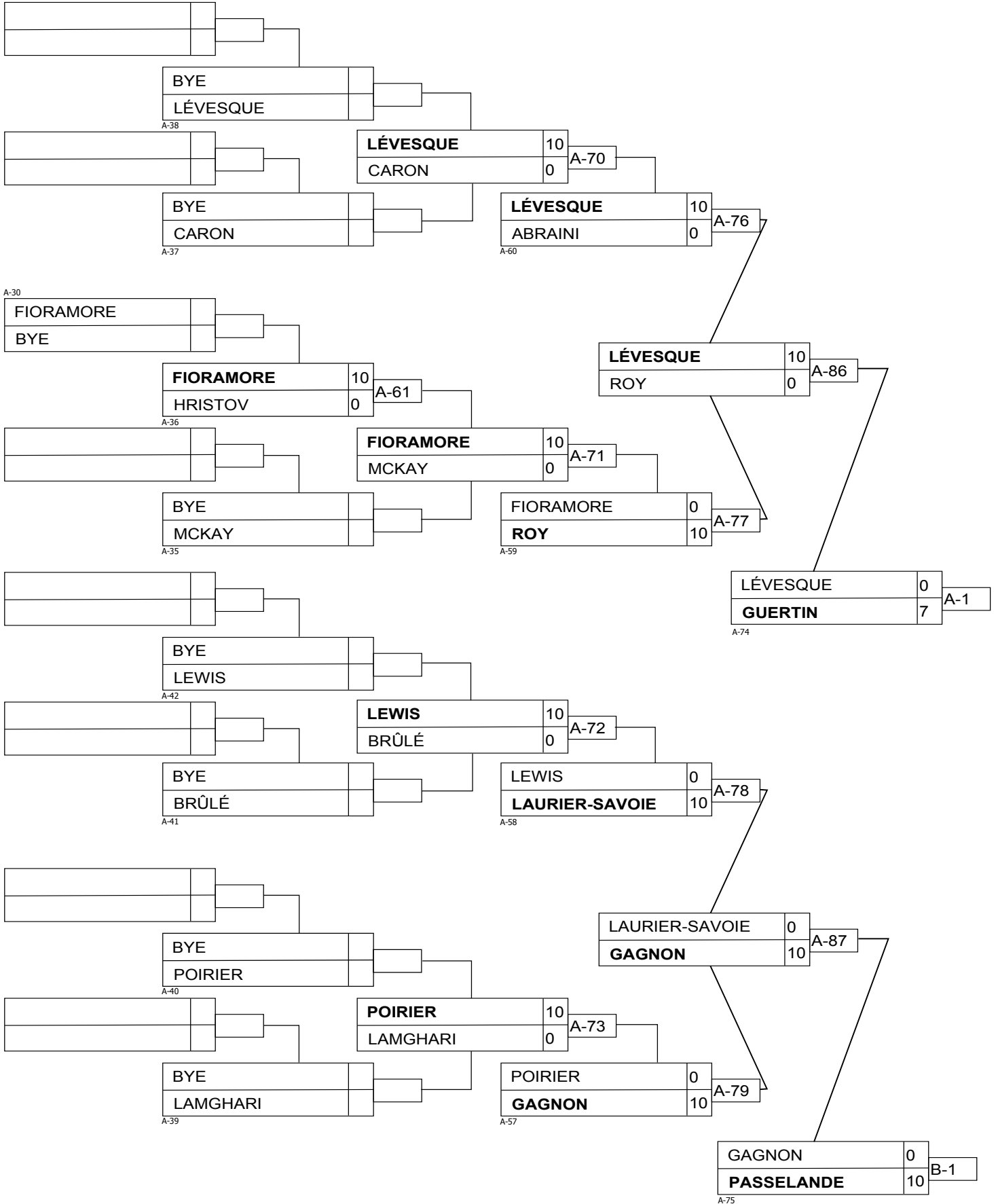

# U16M -46 kg

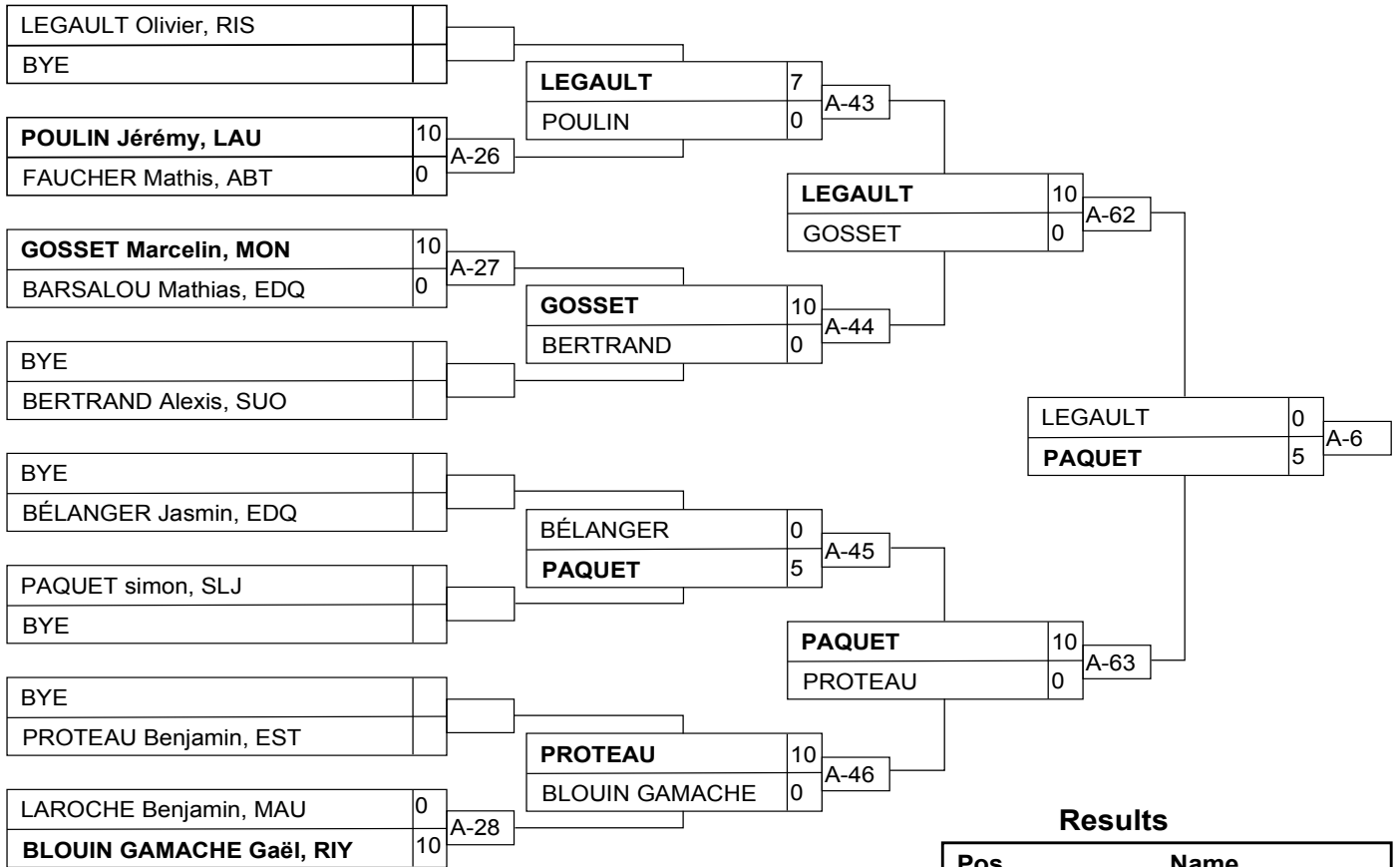

## Results

Pos	Name
1	PAQUET simon, SLJ
2	LEGAULT Olivier, RIS
3	BÉLANGER Jasmin, EDQ
3	PROTEAU Benjamin, EST

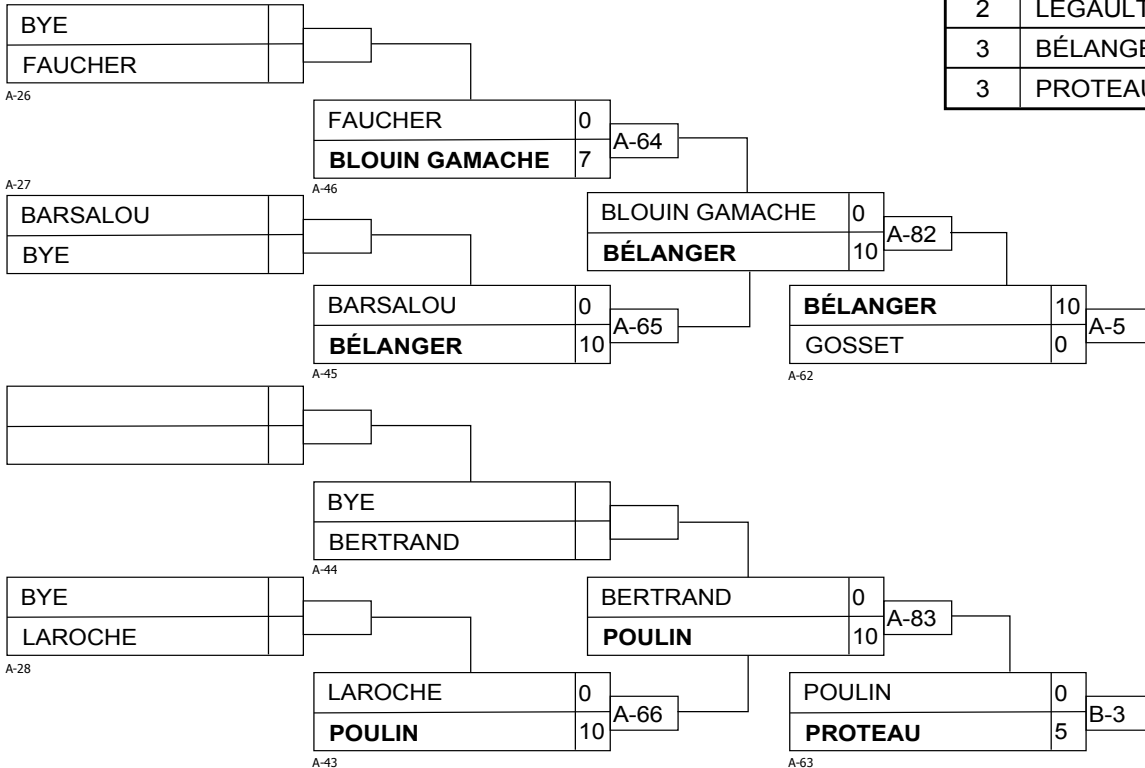

# U16M -50 kg

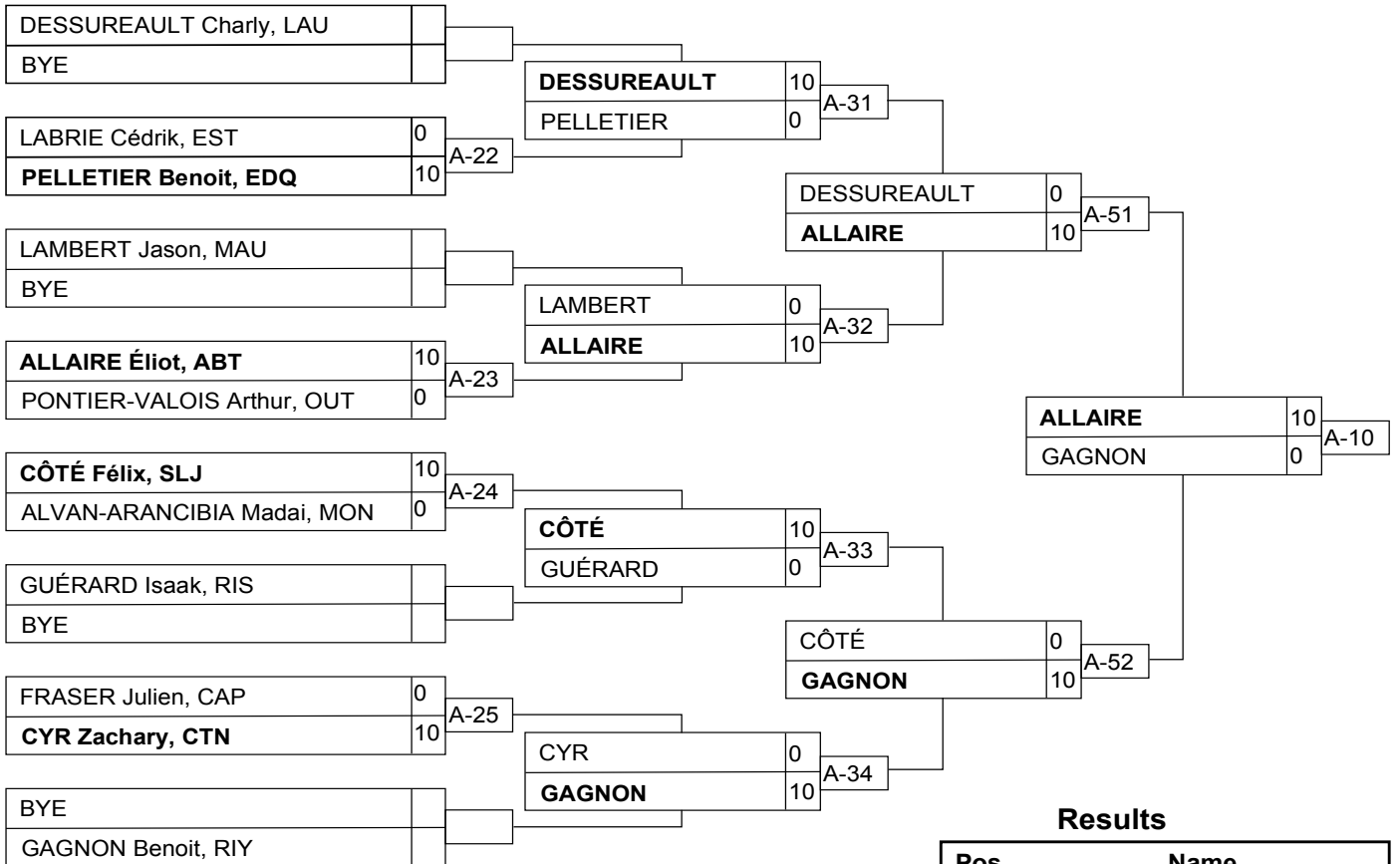

## Results

Pos	Name
1	ALLAIRE Éliot, ABT
2	GAGNON Benoit, RIY
3	GUÉRARD Isaak, RIS
3	CÔTÉ Félix, SLJ

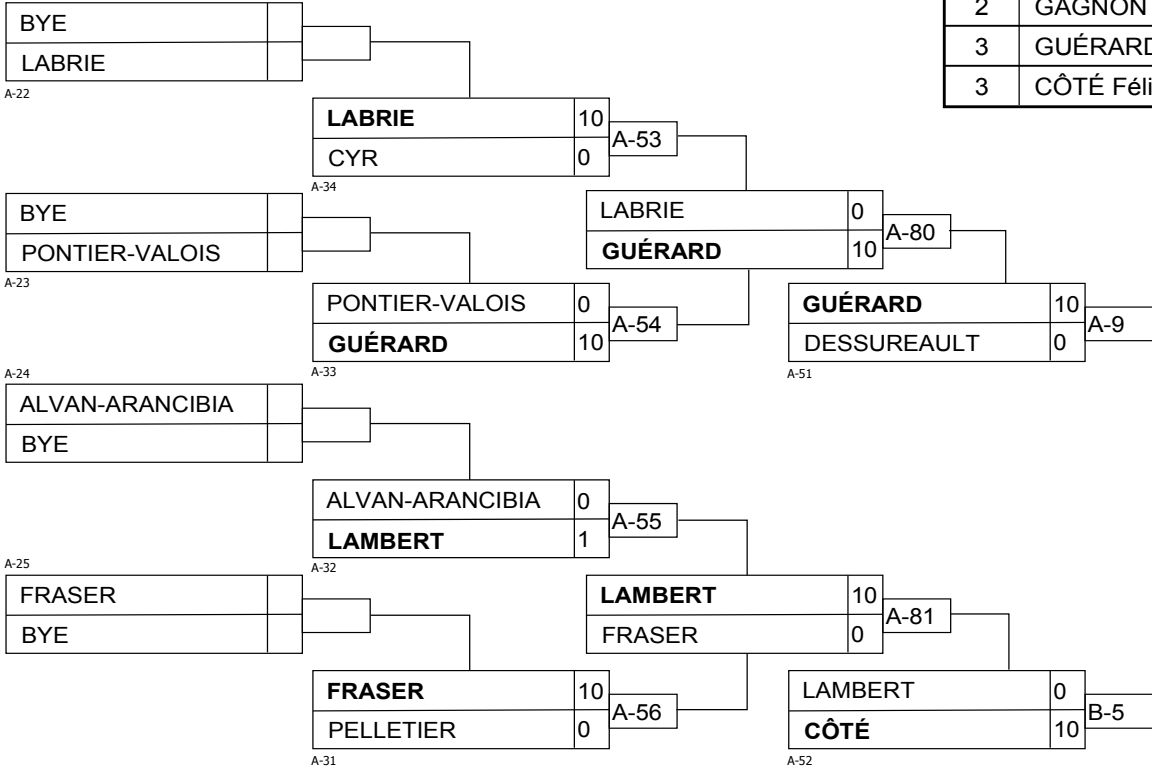

# U16M -55 kg

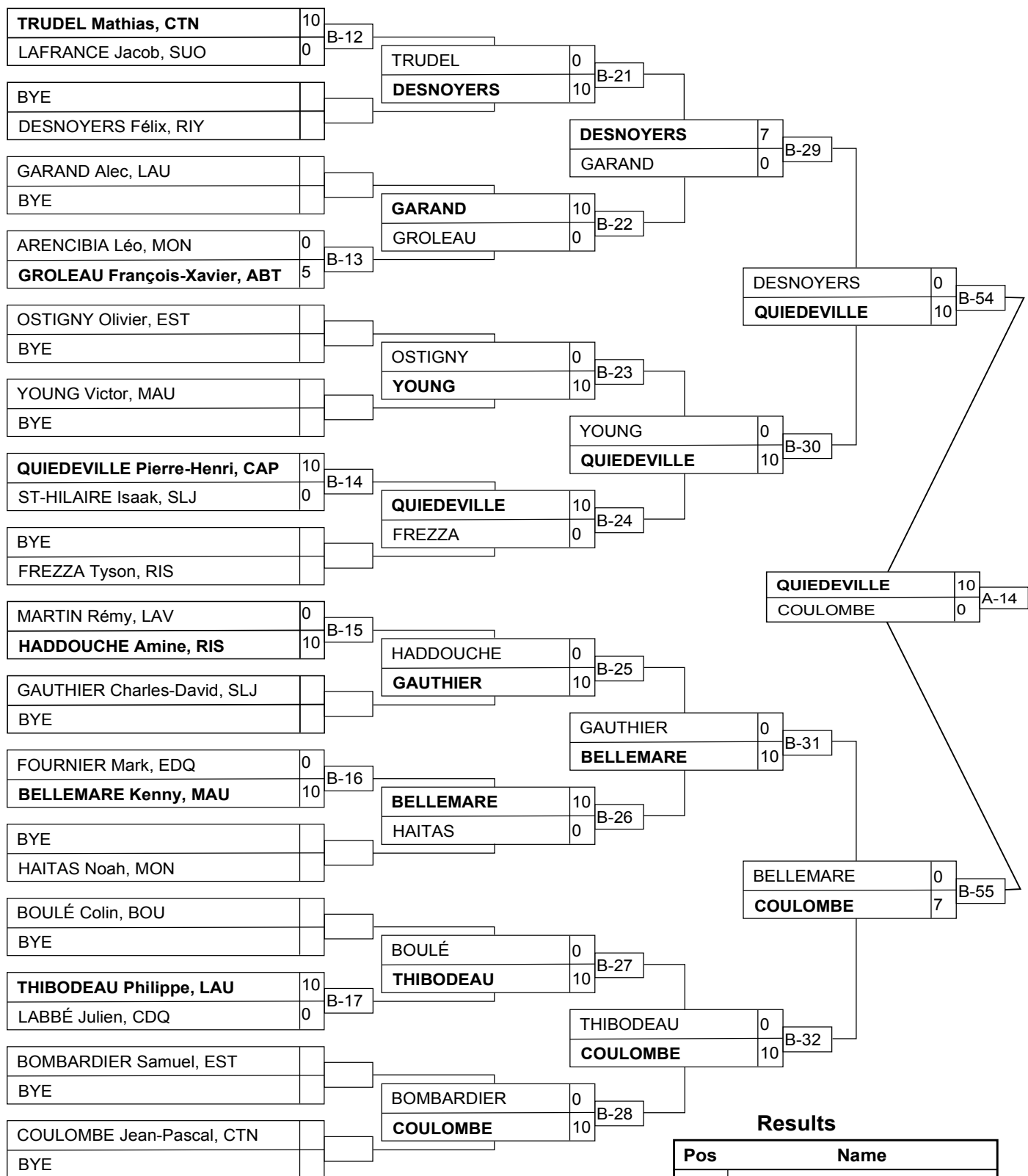



# U16M -55 kg

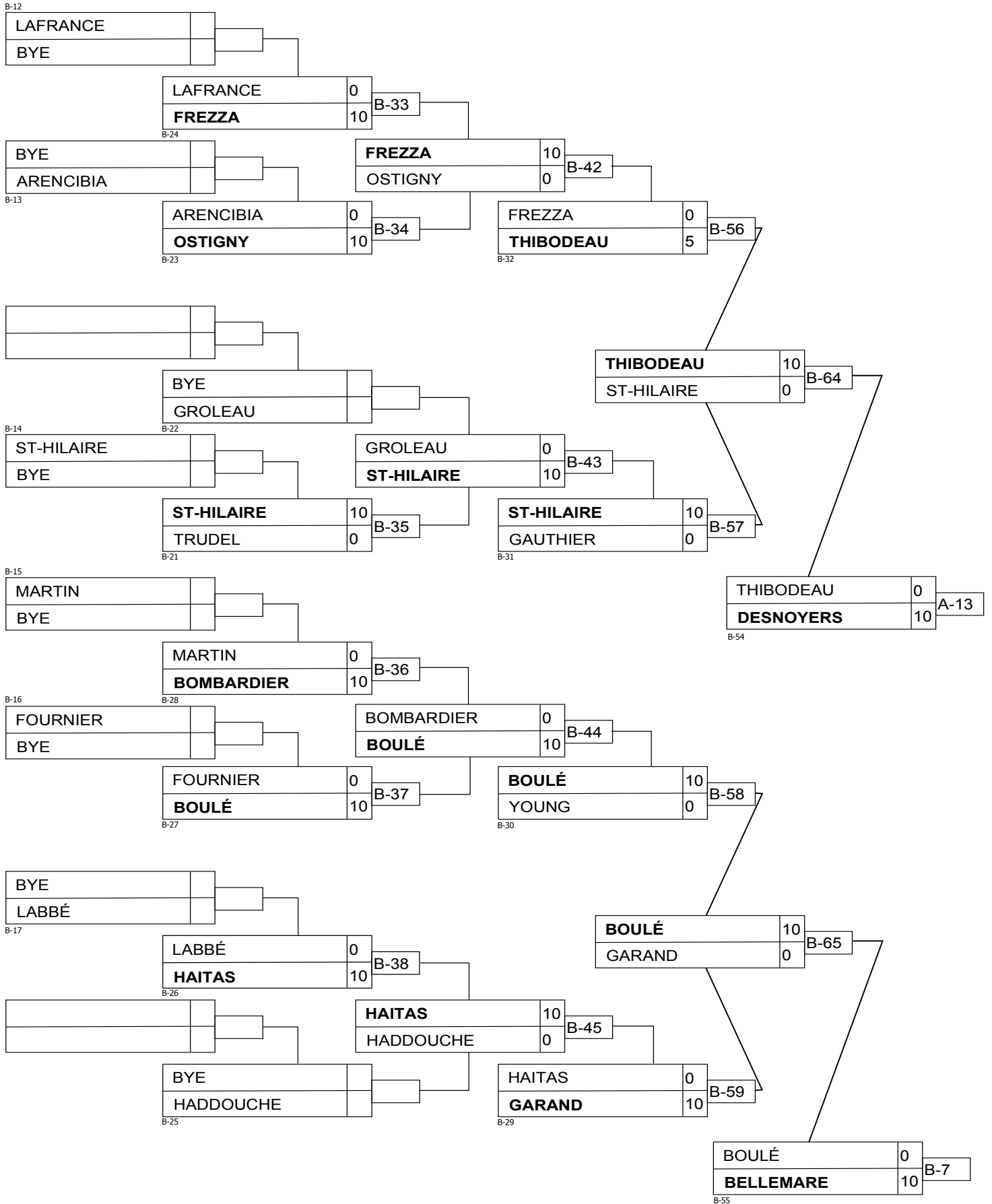

# JEUX du QC 01-03-17 Alma U16F +63 kg

Competitors: 7

## Competitors A

#	Name	Club	1	2	3	4	Wins	Pts	Pos
1	CURADEAU-ROCHEFORT Marie-Noëlle	EDQ					0	0	4
2	DESBIENS Sara	SLJ	10				1	10	3
3	CLOUTIER Alyson	MAU	10	10			2	20	2
4	ARCHAMBAULT Audrey	EST	10	5	10		3	25	1

## Matches A

Match	White	Blue	Result	Time	Code
A-28	CURADEAU-ROCHEFORT Marie-Noëlle 1 2	DESBIENS Sara	0 - 10	0:27	WIP
A-29	CLOUTIER Alyson 3 4	ARCHAMBAULT Audrey	0 - 10	1:30	IPO
A-48	CURADEAU-ROCHEFORT Marie-Noëlle 1 3	CLOUTIER Alyson	0 - 10	1:58	WIP
A-49	DESBIENS Sara 2 4	ARCHAMBAULT Audrey	0 - 5	3:00	YUK
A-63	CURADEAU-ROCHEFORT Marie-Noëlle 1 4	ARCHAMBAULT Audrey	0 - 10	0:01	FUS
A-64	DESBIENS Sara 2 3	CLOUTIER Alyson	0 - 10	2:21	IPO

## Competitors B

#	Name	Club	5	6	7	Wins	Pts	Pos
5	LEFEBVRE Élodie	EST		10	10	2	20	1
6	GENDRON Erica	EDQ				0	0	3
7	GÉLINAS Sara	RIS		10		1	10	2

## Matches B

Match	White	Blue	Result	Time	Code
A-30	LEFEBVRE Élodie 5 6	GENDRON Erica	10 - 0	0:24	WIP
A-50	LEFEBVRE Élodie 5 7	GÉLINAS Sara	10 - 0	0:32	IPO
A-65	GENDRON Erica 6 7	GÉLINAS Sara	0 - 10	0:30	IPO

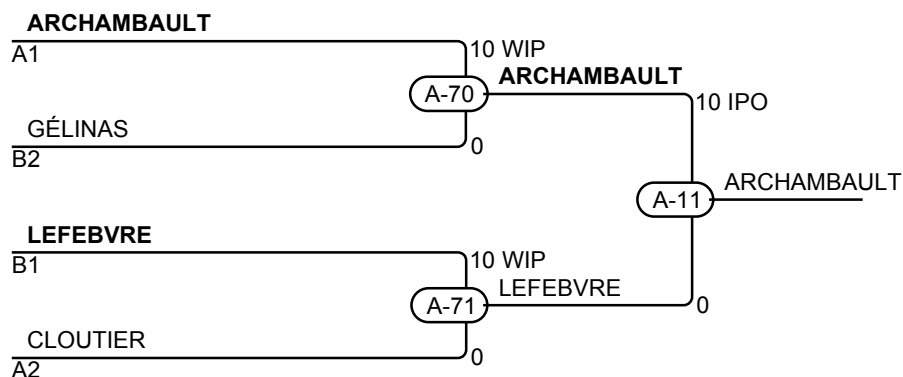

## Results

Pos	Name
1	ARCHAMBAULT Audrey, EST
2	LEFEBVRE Élodie, EST
3	GÉLINAS Sara, RIS
3	CLOUTIER Alyson, MAU

# U16F -57 kg

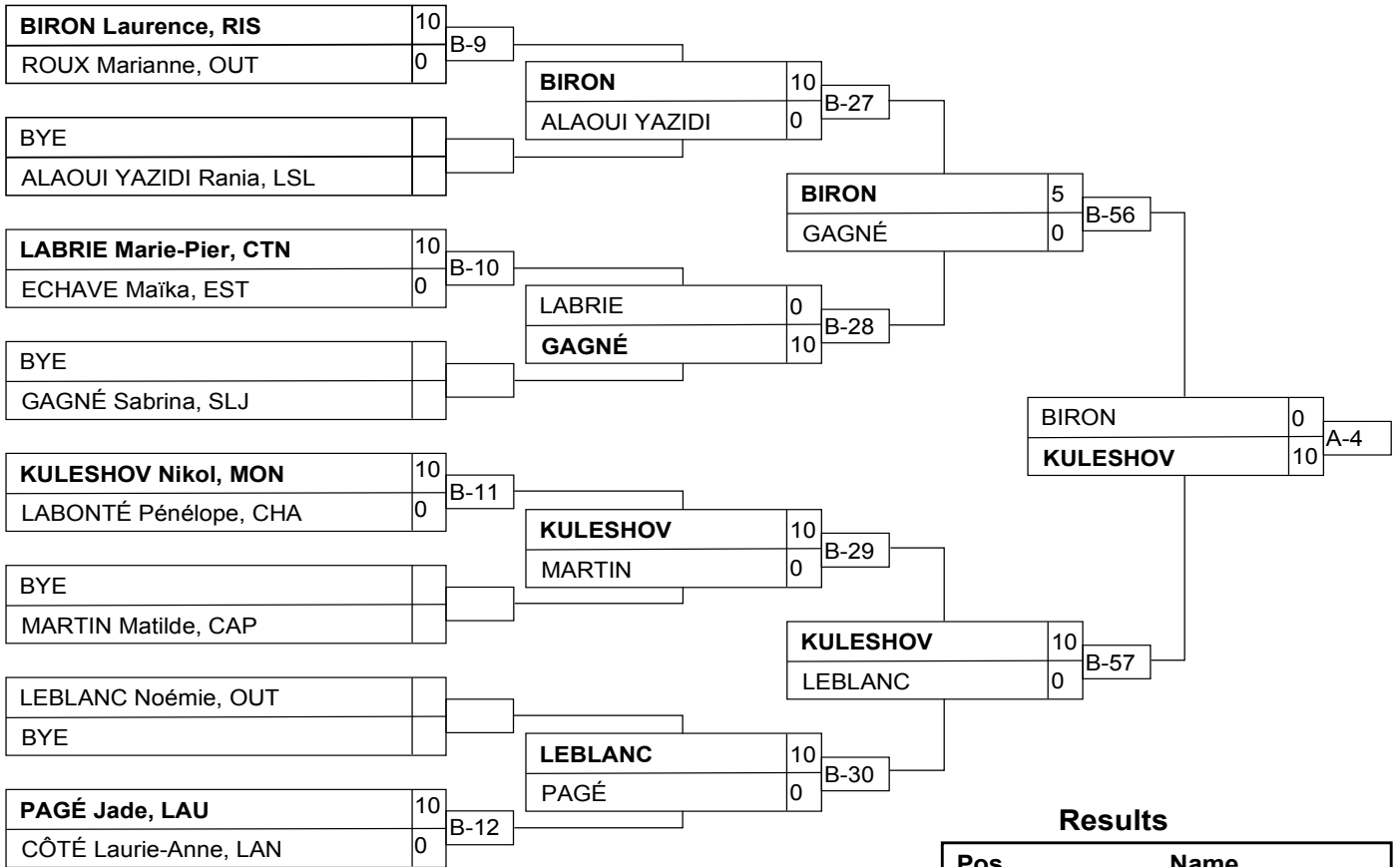

## Results

Pos	Name
1	KULESHOV Nikol, MON
2	BIRON Laurence, RIS
3	ROUX Marianne, OUT
3	LABRIE Marie-Pier, CTN

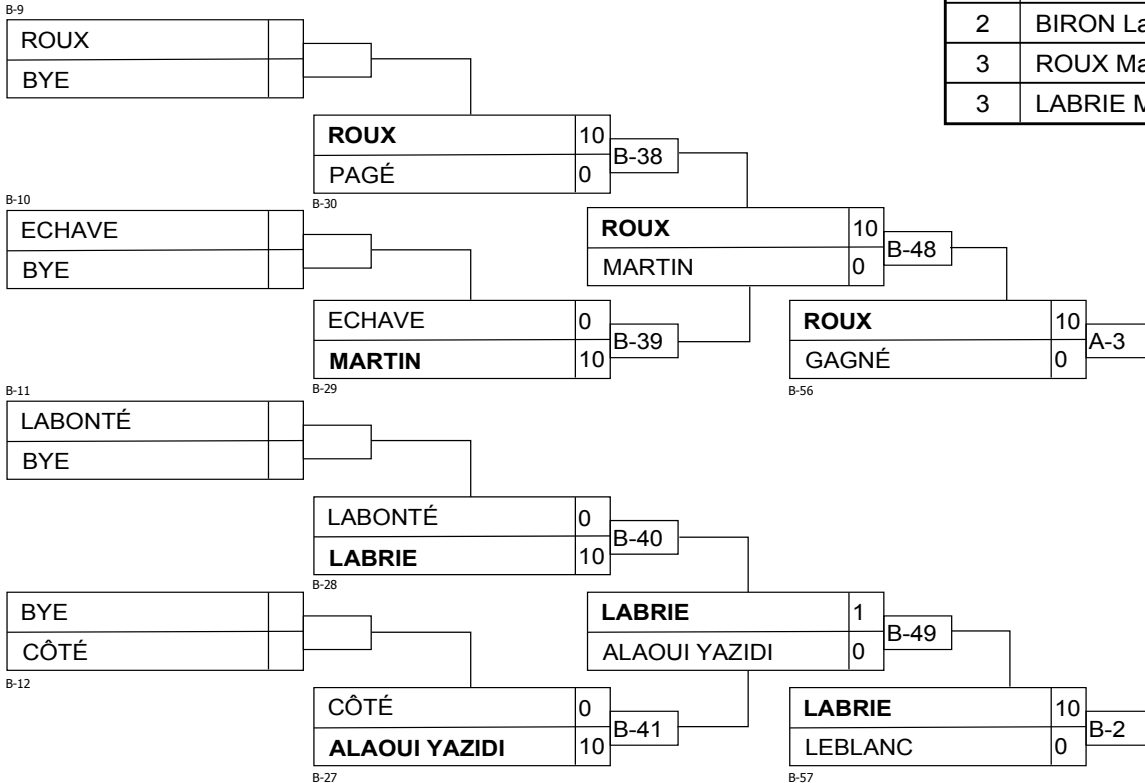

# U16F -63 kg

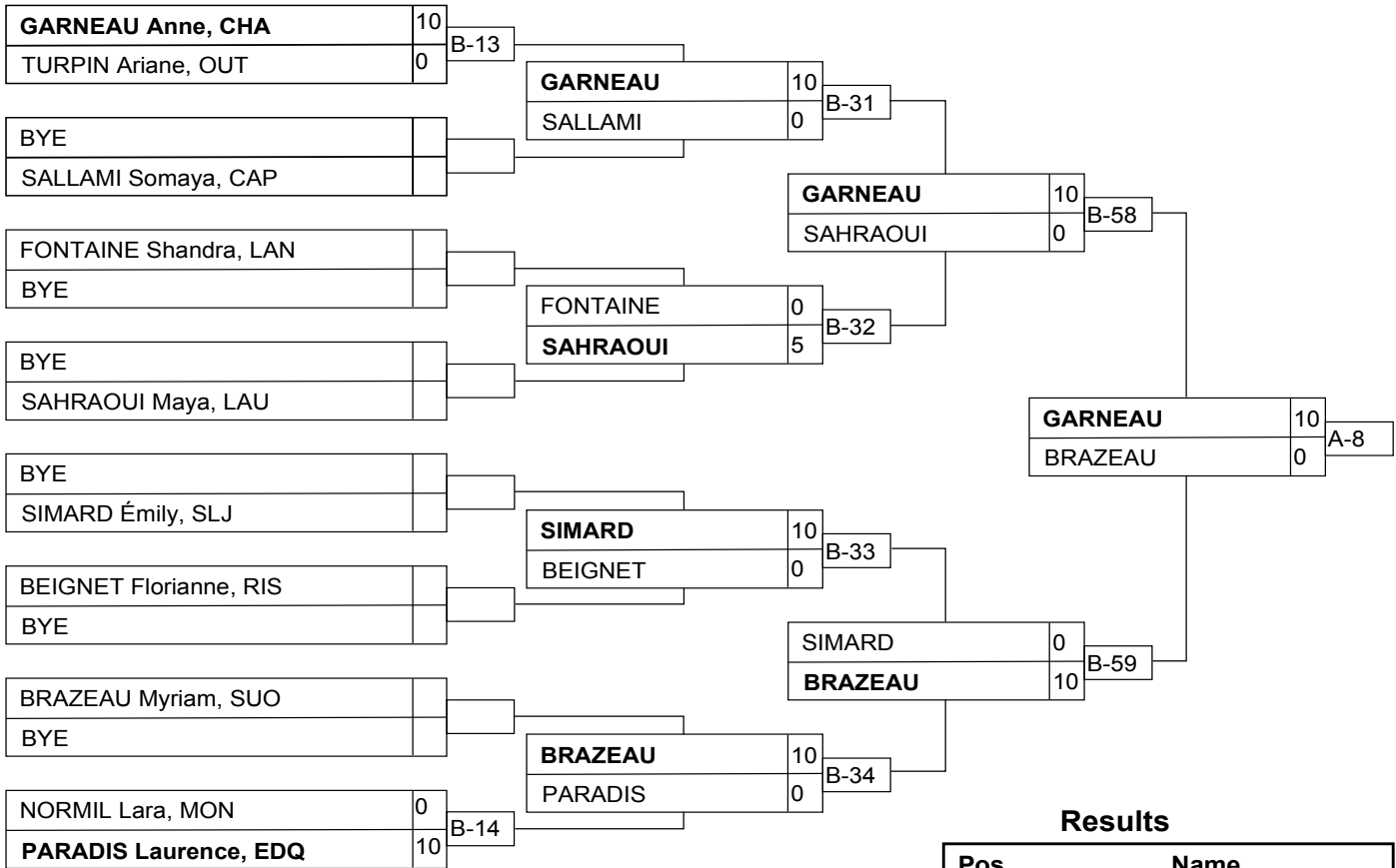

## Results

Pos	Name
1	GARNEAU Anne, CHA
2	BRAZEAU Myriam, SUO
3	PARADIS Laurence, EDQ
3	NORMIL Lara, MON

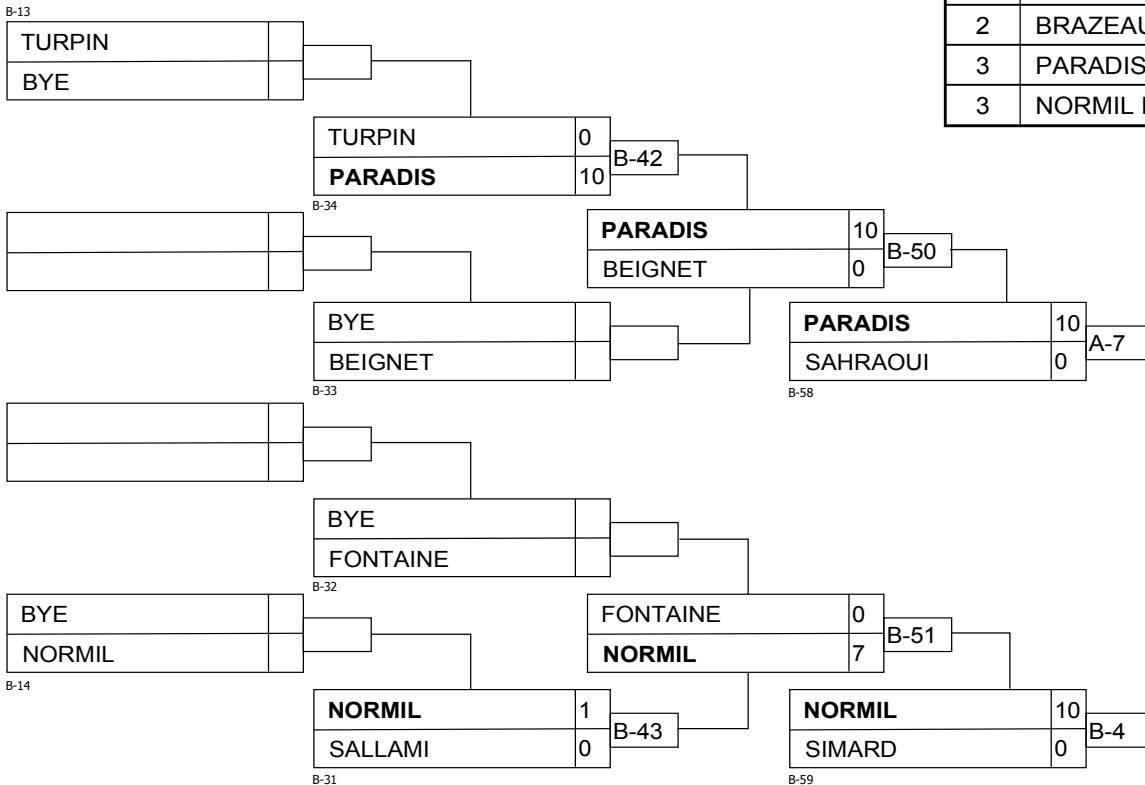

# JEUX du QC 01-03-17 Alma U16M +73 kg

Competitors: 6

## Competitors A

#	Name	Club	1	2	3	Wins	Pts	Pos
1	LAPIERRE Maxim	CDQ		10		1	10	2
2	SARATEANU Peter	SUO				0	0	3
3	ABA Ramy	LAN	10	10		2	20	1

## Matches A

Match	White			Blue	Result	Time	Code
A-18	LAPIERRE Maxim	1	2	SARATEANU Peter	10 - 0	0:31	IPO
A-41	LAPIERRE Maxim	1	3	ABA Ramy	0 - 10	2:03	WIP
A-61	SARATEANU Peter	2	3	ABA Ramy	0 - 10	0:35	IPO

## Competitors B

#	Name	Club	4	5	6	Wins	Pts	Pos
4	CÔTÉ FÉLIX	SLJ		10		1	10	2
5	HAMEL Alex	RIY				0	0	3
6	VALLIÈRE Simon	ABT	10	10		2	20	1

## Matches B

Match	White			Blue	Result	Time	Code
A-19	CÔTÉ FÉLIX	4	5	HAMEL Alex	10 - 0	0:19	IPO
A-42	CÔTÉ FÉLIX	4	6	VALLIÈRE Simon	0 - 10	0:20	IPO
A-62	HAMEL Alex	5	6	VALLIÈRE Simon	0 - 10	0:10	IPO

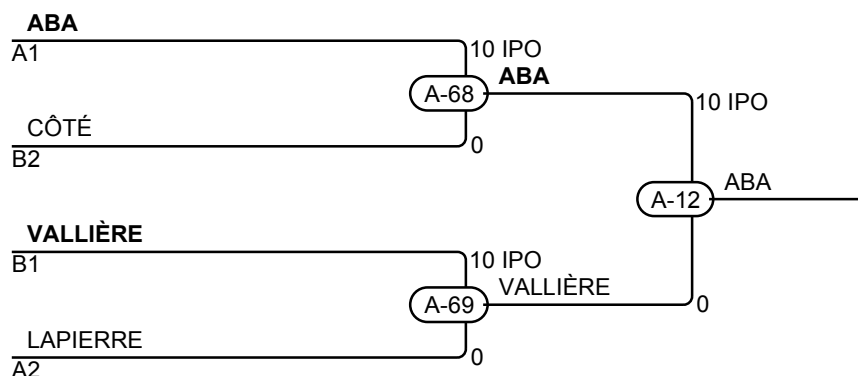

## Results

Pos	Name
1	ABA Ramy, LAN
2	VALLIÈRE Simon, ABT
3	CÔTÉ FÉLIX, SLJ
3	LAPIERRE Maxim, CDQ

# U16M -60 kg

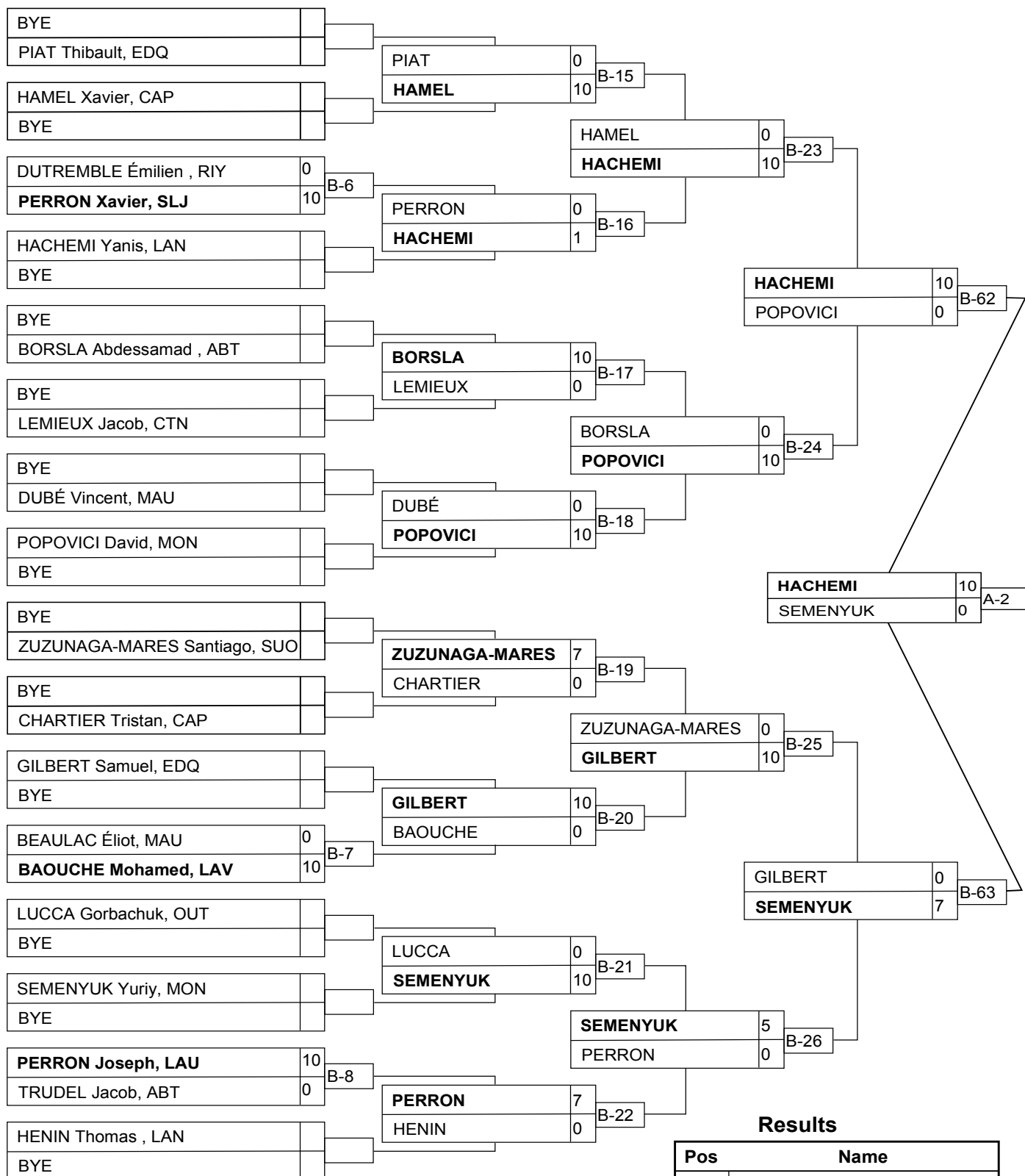

## Results

Pos	Name
1	HACHEMI Yanis, LAN
2	SEMENYUK Yuriy, MON
3	PERRON Xavier, SLJ
3	BAUCHE Mohamed, LAV

# U16M -60 kg

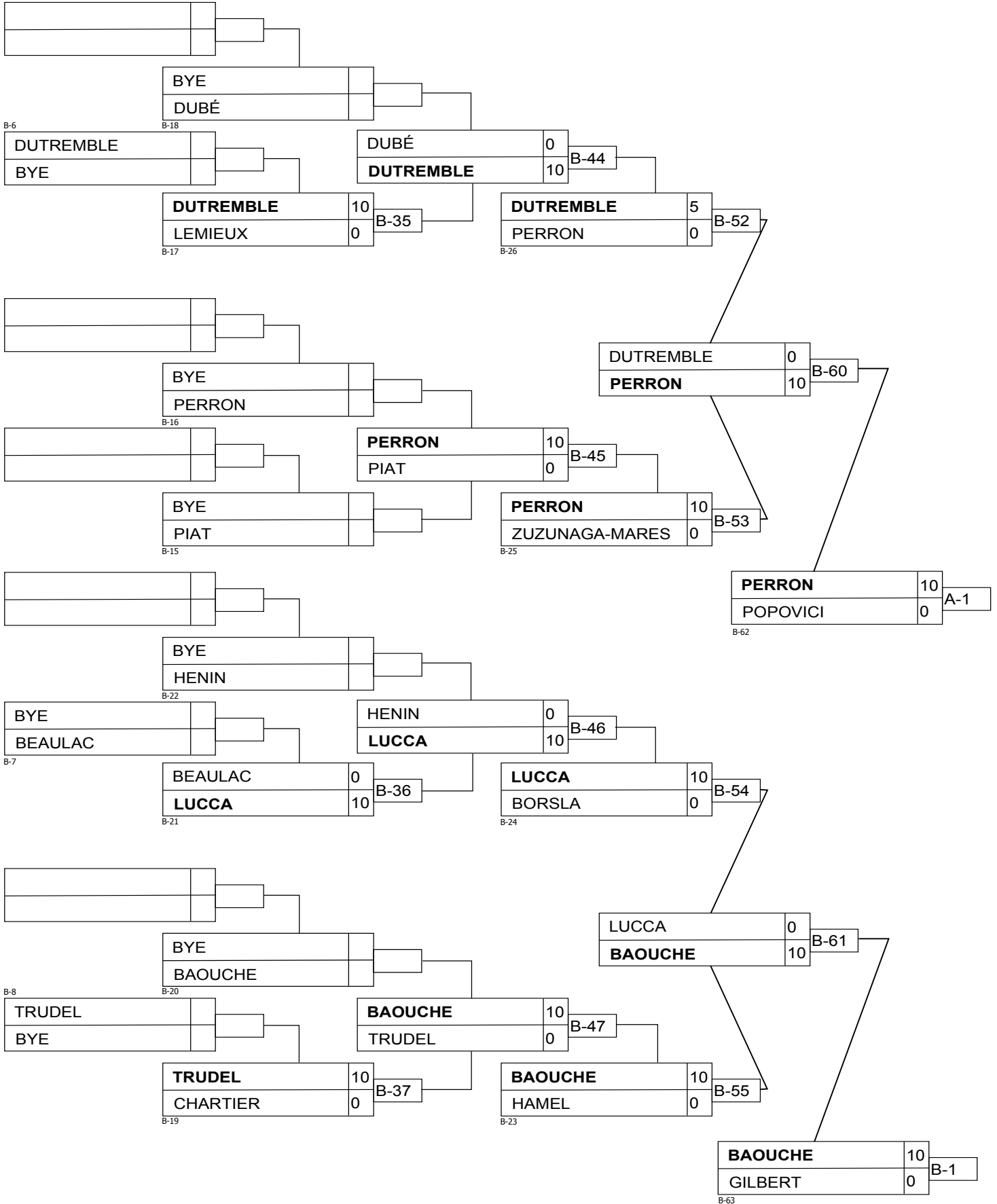

# U16M -66 kg

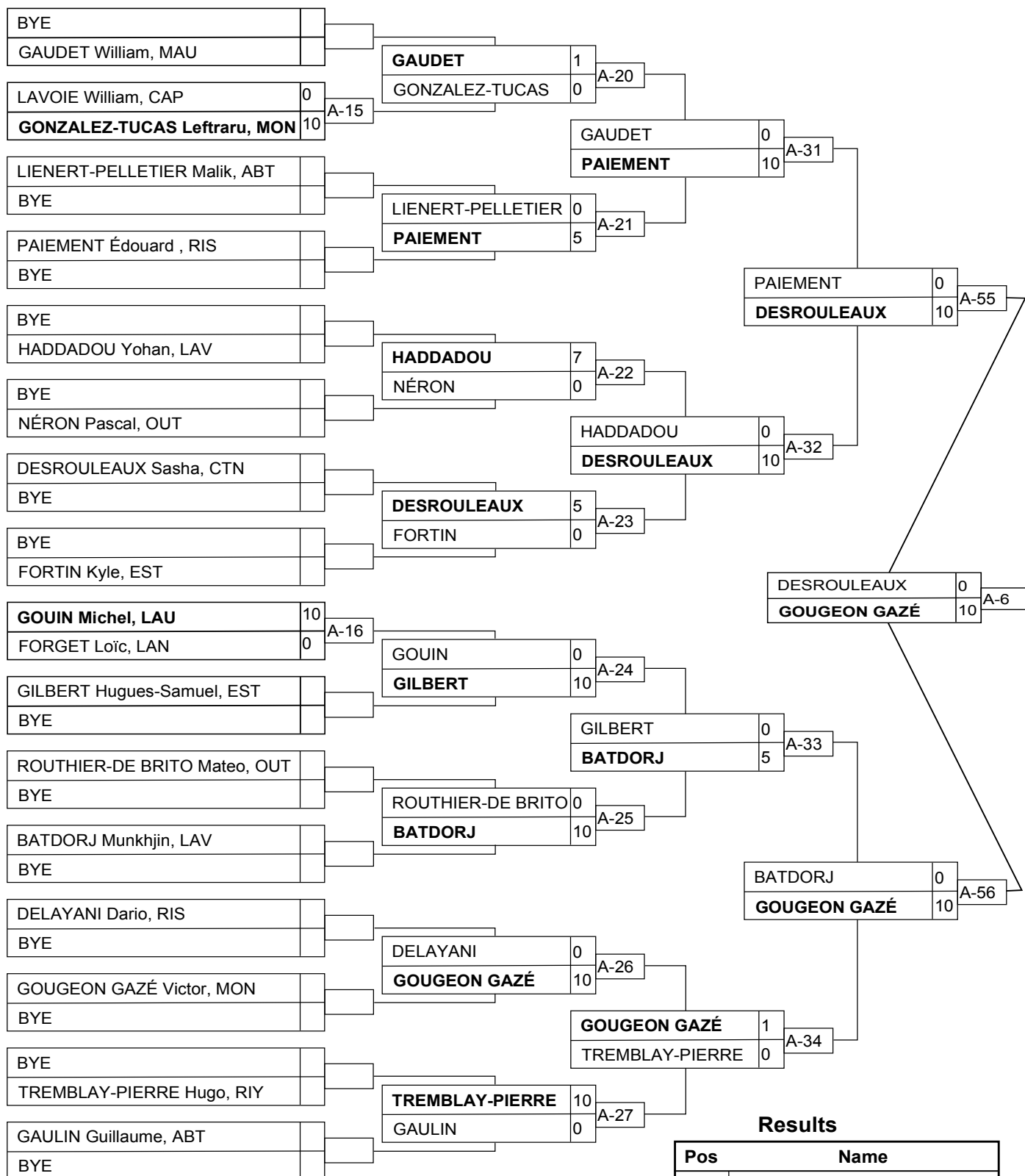



# U16M -66 kg

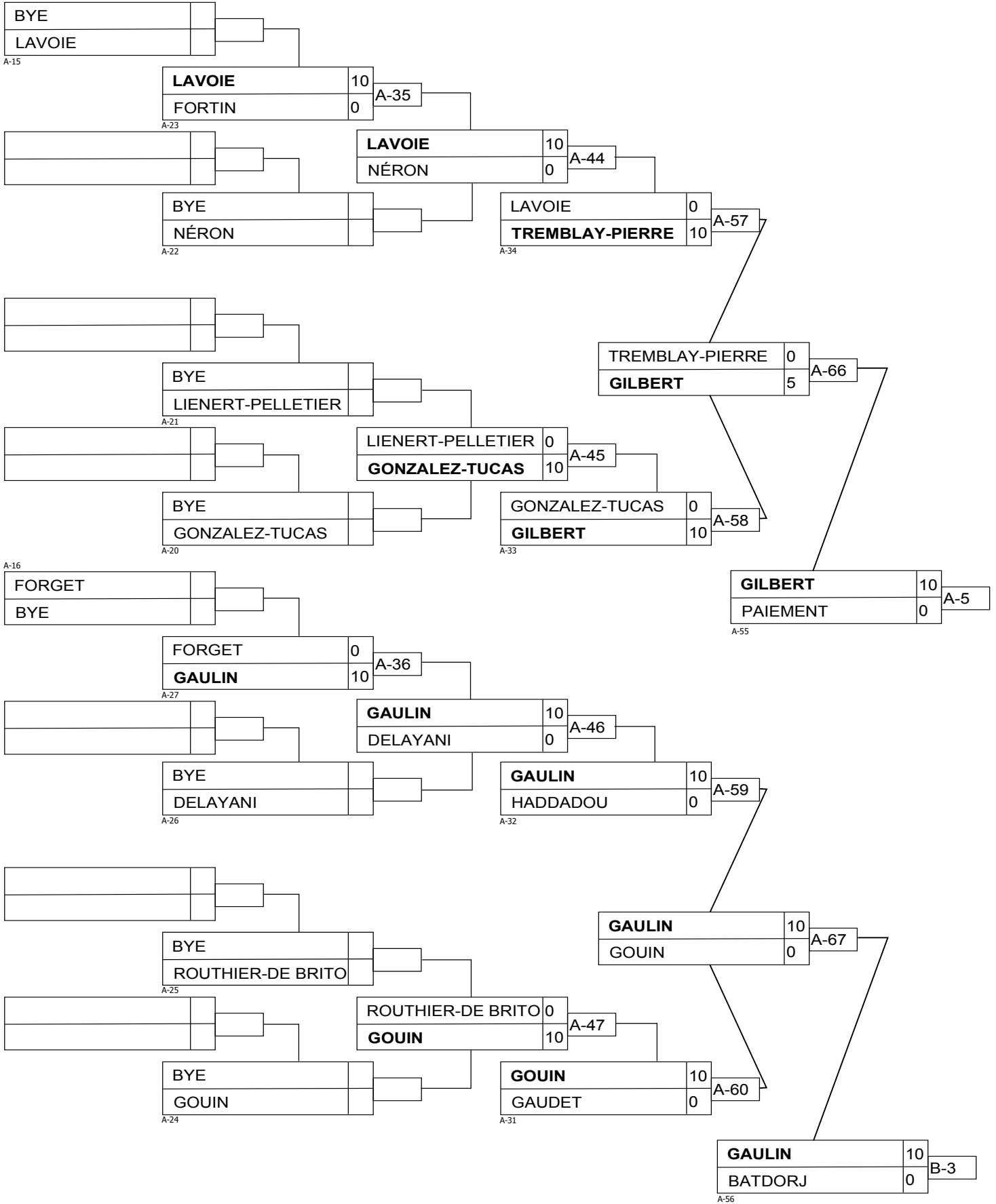

# U16M -73 kg

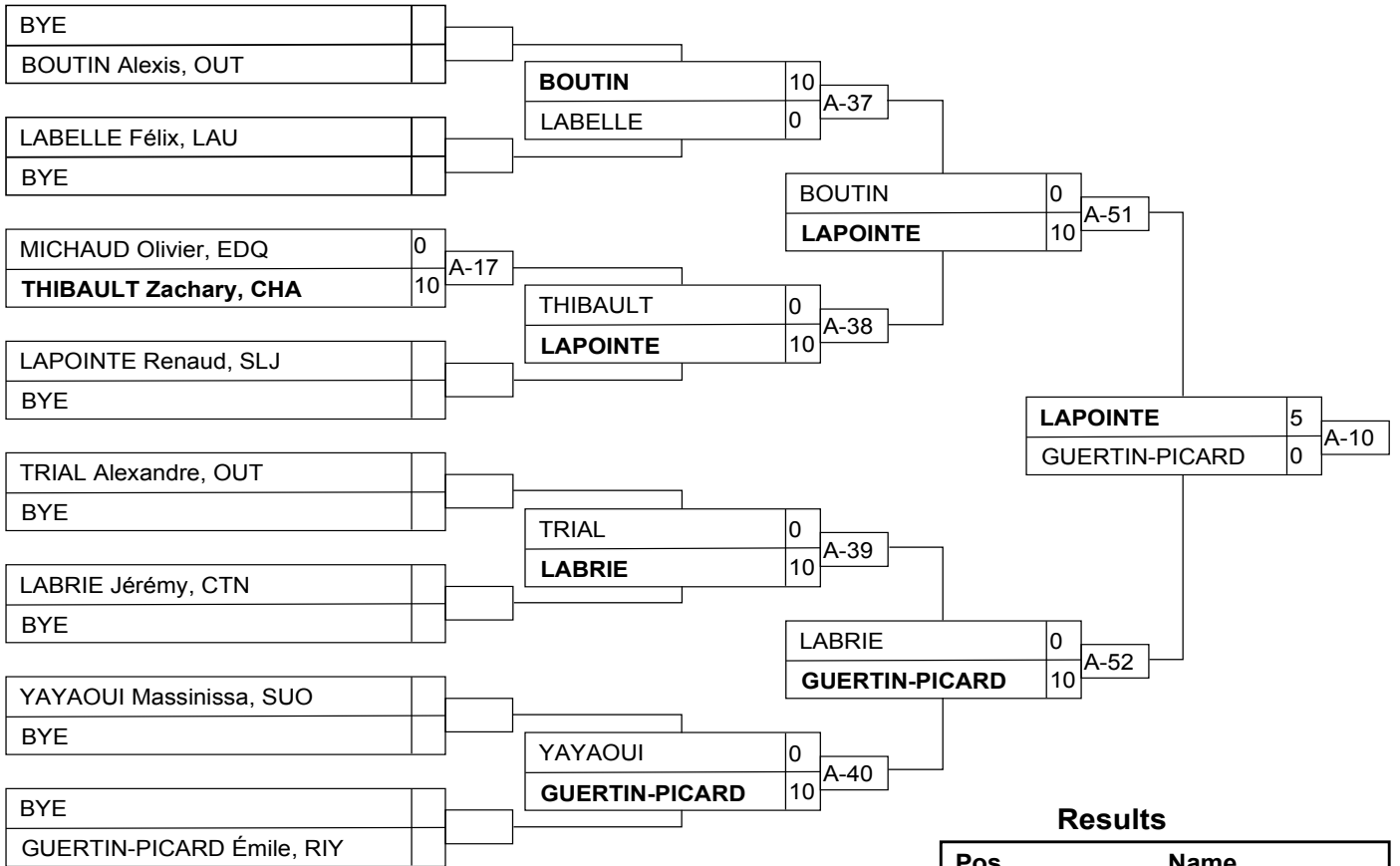

## Results

Pos	Name
1	LAPOINTE Renaud, SLJ
2	GUERTIN-PICARD Émile, RIY
3	BOUTIN Alexis, OUT
3	LABRIE Jérémy, CTN