

U18F -48V+

Compétiteurs/Competitors

| # | Nom/Name | Grade | Club | 1 | 2 | 3 | G/W | Pts | Pos |
|---|-------------------|-------|----------------|----|----|----|-----|-----|-----|
| 1 | LACHAÎNE Aiko | 1k | kyo shi do kan | XX | | | 0 | 0 | 3 |
| 2 | CÔTÉ Eleonore | 1k | beauport | 10 | XX | | 1 | 10 | 2 |
| 3 | SOMERS Andrée-Ann | 1k | sept-iles | 10 | 10 | XX | 2 | 20 | 1 |

Matches/Matches

| Match | Blanc/White | | | Bleu/Blue | Rés/Res | Tmp/Tim | Code |
|-------|---------------|---|---|-------------------|---------|---------|------|
| A-25 | LACHAÎNE Aiko | 1 | 2 | CÔTÉ Eleonore | 0 - 10 | 3:09 | IPO |
| A-31 | LACHAÎNE Aiko | 1 | 3 | SOMERS Andrée-Ann | 0 - 10 | 0:18 | IPO |
| A-35 | CÔTÉ Eleonore | 2 | 3 | SOMERS Andrée-Ann | 0 - 10 | 2:39 | IPO |

Résultats/Results

| Pos | Nom/Name |
|-----|-------------------------------|
| 1 | SOMERS Andrée-Ann, sept-iles |
| 2 | CÔTÉ Eleonore, beauport |
| 3 | LACHAÎNE Aiko, kyo shi do kan |

U18F -52V+

Compétiteurs/Competitors

| # | Nom/Name | Grade | Club | 1 | 2 | 3 | 4 | G/W | Pts | Pos |
|---|----------------------|-------|---------------|----|----|----|----|-----|-----|-----|
| 1 | MIREAULT Juliette | 3k | torakai | XX | | | | 0 | 0 | 4 |
| 2 | BOUSBIAT Amira | 1k | boucherville | 10 | XX | 10 | 10 | 3 | 30 | 1 |
| 3 | AKOMO MVOLO Keren-Ha | 3k | st-jean-bosco | 10 | | XX | | 1 | 10 | 3 |
| 4 | GRENIER Amélie | 1k | laterriere | 10 | | 10 | XX | 2 | 20 | 2 |

Matches/Matches

| Match | Blanc/White | | | Bleu/Blue | Rés/Res | Tmp/Tim | Code |
|-------|----------------------|---|---|----------------------|---------|---------|------|
| B-15 | MIREAULT Juliette | 1 | 2 | BOUSBIAT Amira | 0 - 10 | 0:42 | IPO |
| B-16 | AKOMO MVOLO Keren-Ha | 3 | 4 | GRENIER Amélie | 0 - 10 | 0:29 | IPO |
| B-21 | MIREAULT Juliette | 1 | 3 | AKOMO MVOLO Keren-Ha | 0 - 10 | 0:25 | IPO |
| B-22 | BOUSBIAT Amira | 2 | 4 | GRENIER Amélie | 10 - 0 | 2:37 | IPO |
| B-29 | MIREAULT Juliette | 1 | 4 | GRENIER Amélie | 0 - 10 | 0:12 | IPO |
| B-30 | BOUSBIAT Amira | 2 | 3 | AKOMO MVOLO Keren-Ha | 10 - 0 | 1:02 | IPO |

Résultats/Results

| Pos | Nom/Name |
|-----|-------------------------------------|
| 1 | BOUSBIAT Amira, boucherville |
| 2 | GRENIER Amélie, laterriere |
| 3 | AKOMO MVOLO Keren-Ha, st-jean-bosco |
| 4 | MIREAULT Juliette, torakai |

U18F -57V+

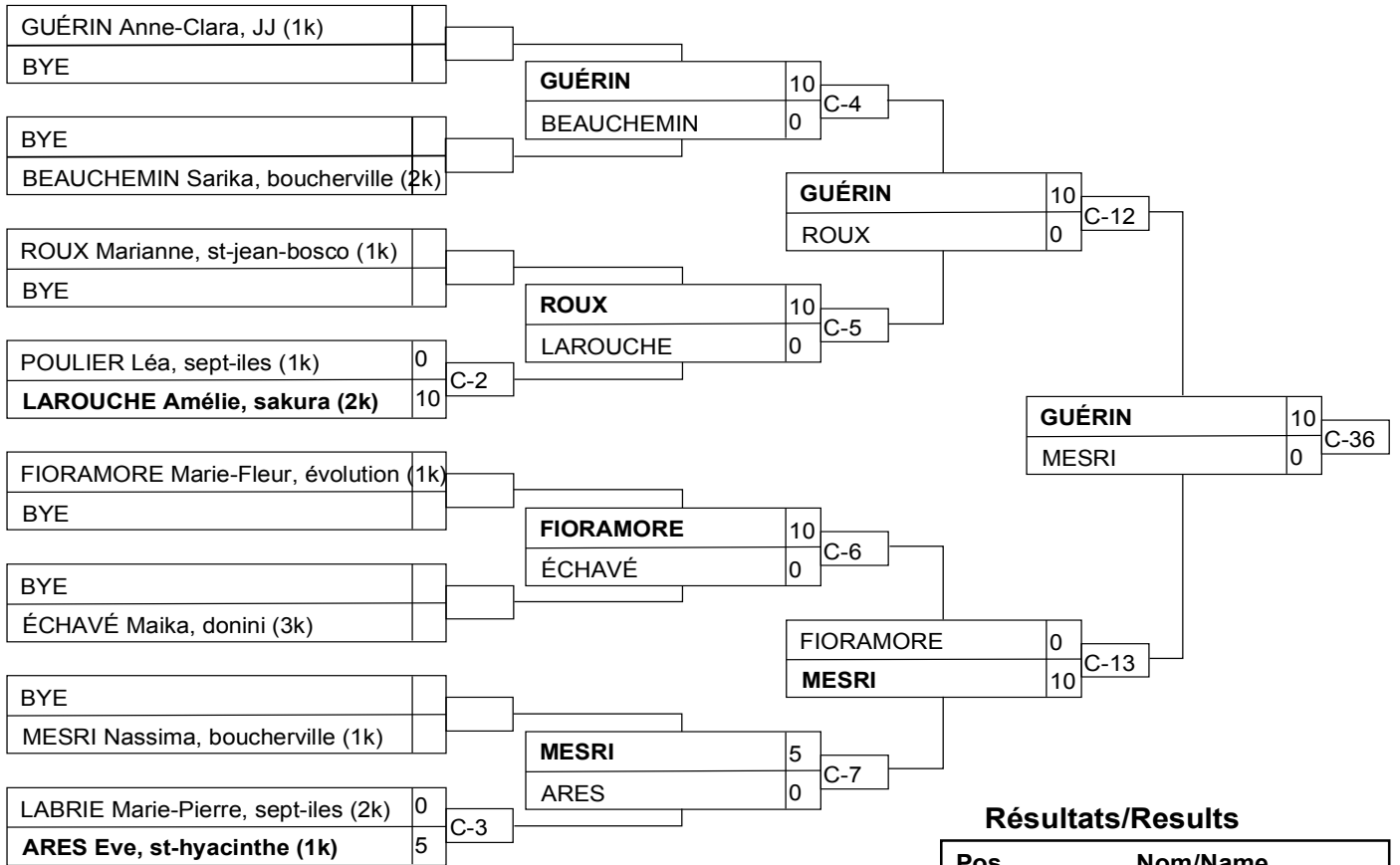

Résultats/Results

| Pos | Nom/Name |
|-----|---------------------------------------|
| 1 | GUÉRIN Anne-Clara, JJ (1k) |
| 2 | MESRI Nassima, boucherville (1k) |
| 3 | ROUX Marianne, st-jean-bosco (1k) |
| 3 | FIORAMORE Marie-Fleur, évolution (1k) |

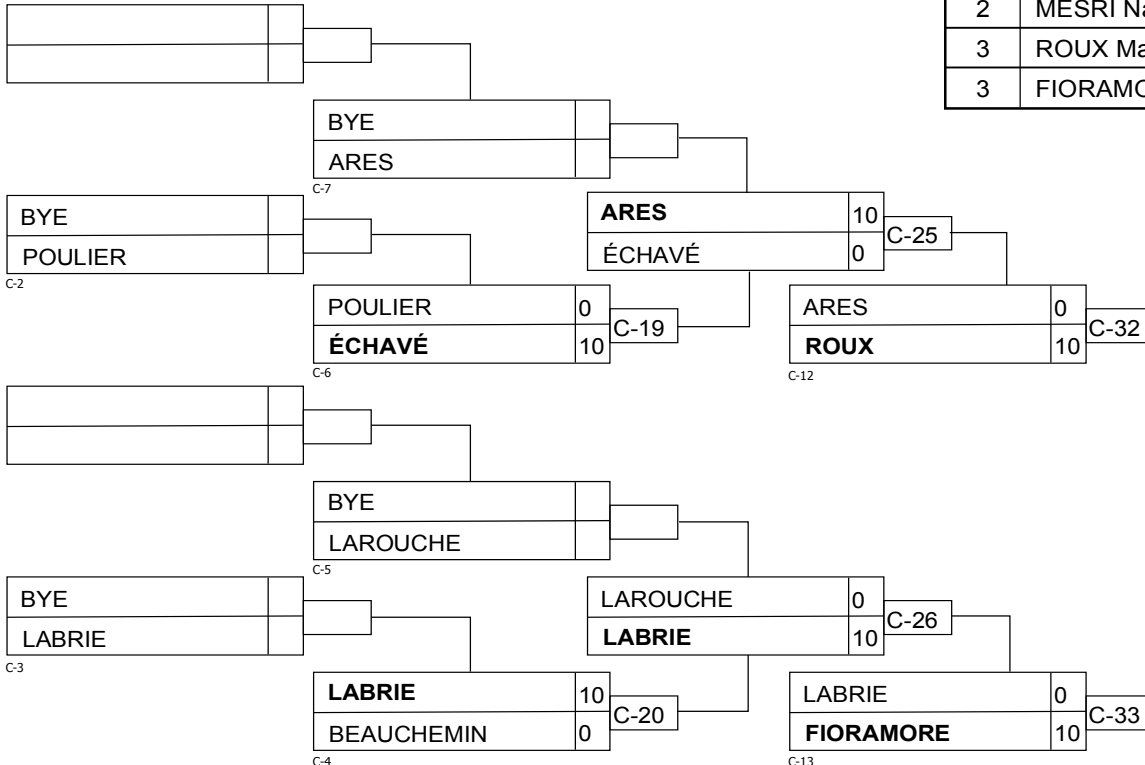

U18F -63JO

Compétiteurs/Competitors

| # | Nom/Name | Grade | Club | 1 | 2 | 1 | 2 | 1 | 2 | G/W | Pts | Pos |
|---|----------------|-------|--------------|----|----|----|----|----|----|-----|-----|-----|
| 1 | LAVOIE Saskia | 5k | zenshin | XX | 10 | XX | 10 | XX | | 2 | 20 | 1 |
| 2 | SAUVESTRE Jade | 4k+ | charlesbourg | | XX | | XX | | XX | 0 | 0 | 2 |

Matches/Matches

| Match | Blanc/White | | | Bleu/Blue | Rés/Res | Tmp/Tim | Code |
|-------|----------------|---|---|----------------|---------|---------|------|
| C-18 | LAVOIE Saskia | 1 | 2 | SAUVESTRE Jade | 10 - 0 | 3:34 | IPO |
| C-24 | SAUVESTRE Jade | 2 | 1 | LAVOIE Saskia | 0 - 10 | 0:01 | FUS |
| C-31 | LAVOIE Saskia | 1 | 2 | SAUVESTRE Jade | | | |

Résultats/Results

| Pos | Nom/Name |
|-----|------------------------------|
| 1 | LAVOIE Saskia, zenshin |
| 2 | SAUVESTRE Jade, charlesbourg |

U18F -63V+

Compétiteurs/Competitors A

| # | Nom/Name | Grade | Club | 1 | 2 | 3 | 4 | G/W | Pts | Pos |
|---|------------------|-------|--------------|----|----|----|----|-----|-----|-----|
| 1 | BRAZEAU Myriam | 2k | perrot shima | XX | 10 | 10 | 10 | 3 | 30 | 1 |
| 2 | CLOUTIER Alyson | 3k | seikidokan | | XX | | | 0 | 0 | 4 |
| 3 | PARADIS Laurence | 2k | judo-tani | | 10 | XX | | 1 | 10 | 3 |
| 4 | GELINAS Sara | 1k | olympique | | 10 | 10 | XX | 2 | 20 | 2 |

Matches/Matches A

| Match | Blanc/White | | | Bleu/Blue | Rés/Res | Tmp/Tim | Code |
|-------|-----------------------|---|---|-------------------------|---------|---------|------|
| D-3 | BRAZEAU Myriam | 1 | 2 | CLOUTIER Alyson | 10 - 0 | 0:26 | IPO |
| D-4 | PARADIS Laurence | 3 | 4 | GELINAS Sara | 0 - 10 | 0:05 | IPO |
| D-14 | BRAZEAU Myriam | 1 | 3 | PARADIS Laurence | 10 - 0 | 0:22 | IPO |
| D-15 | CLOUTIER Alyson | 2 | 4 | GELINAS Sara | 0 - 10 | 1:47 | IPO |
| D-23 | BRAZEAU Myriam | 1 | 4 | GELINAS Sara | 10 - 0 | 0:29 | IPO |
| D-24 | CLOUTIER Alyson | 2 | 3 | PARADIS Laurence | 0 - 10 | 0:26 | IPO |

Compétiteurs/Competitors B

| # | Nom/Name | Grade | Club | 5 | 6 | 7 | G/W | Pts | Pos |
|---|--------------------|-------|---------------|----|----|----|-----|-----|-----|
| 5 | MARTIN Mathilde | 1k | beauport | XX | | 10 | 1 | 10 | 1 |
| 6 | BOUSSARHANE Samia | 1k | boucherville | 5 | XX | | 1 | 5 | 3 |
| 7 | AVOMO MVOLO Ketsia | 3k | st-jean-bosco | | 10 | XX | 1 | 10 | 2 |

Matches/Matches B

| Match | Blanc/White | | | Bleu/Blue | Rés/Res | Tmp/Tim | Code |
|-------|------------------------|---|---|---------------------------|---------|---------|------|
| D-5 | MARTIN Mathilde | 5 | 6 | BOUSSARHANE Samia | 0 - 5 | 4:00 | WAZ |
| D-16 | MARTIN Mathilde | 5 | 7 | AVOMO MVOLO Ketsia | 10 - 0 | 0:50 | IPO |
| D-25 | BOUSSARHANE Samia | 6 | 7 | AVOMO MVOLO Ketsia | 0 - 10 | 0:01 | FUS |

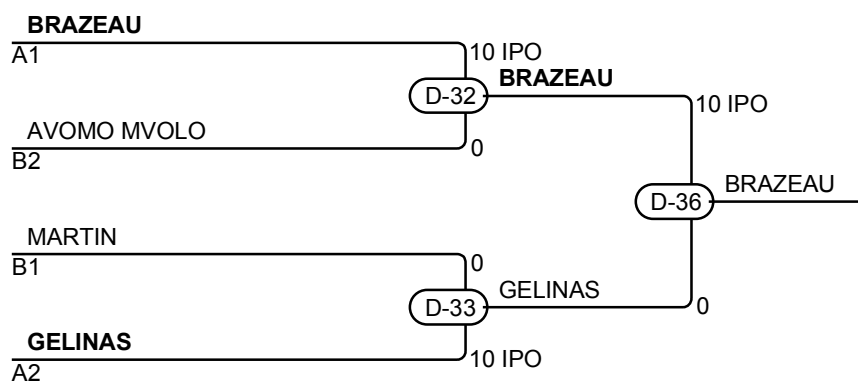

Résultats/Results

| Pos | Nom/Name |
|-----|-----------------------------------|
| 1 | BRAZEAU Myriam, perrot shima |
| 2 | GELINAS Sara, olympique |
| 3 | AVOMO MVOLO Ketsia, st-jean-bosco |
| 3 | MARTIN Mathilde, beauport |

U18F -70V+

Compétiteurs/Competitors

| # | Nom/Name | Grade | Club | 1 | 2 | 1 | 2 | 1 | 2 | G/W | Pts | Pos |
|---|------------------|-------|------------------|----|----|----|----|----|----|-----|-----|-----|
| 1 | GODBOUT Coralie | 1k | vieille capitale | XX | 10 | XX | 10 | XX | | 2 | 20 | 1 |
| 2 | FONTAINE Shandra | 2k | kime-wasa | | XX | | XX | | XX | 0 | 0 | 2 |

Matches/Matches

| Match | Blanc/White | | | Bleu/Blue | Rés/Res | Tmp/Tim | Code |
|-------|------------------------|---|---|------------------------|---------|---------|------|
| A-26 | GODBOUT Coralie | 1 | 2 | FONTAINE Shandra | 10 - 0 | 0:37 | IPO |
| A-32 | FONTAINE Shandra | 2 | 1 | GODBOUT Coralie | 0 - 10 | 0:10 | IPO |
| A-36 | GODBOUT Coralie | 1 | 2 | FONTAINE Shandra | | | |

Résultats/Results

| Pos | Nom/Name |
|-----|-----------------------------------|
| 1 | GODBOUT Coralie, vieille capitale |
| 2 | FONTAINE Shandra, kime-wasa |

U18M -46V+

Compétiteurs/Competitors

| # | Nom/Name | Grade | Club | 1 | 2 | 3 | 4 | 5 | G/W | Pts | Pos |
|---|------------------------|-------|---------------|----|----|----|----|----|-----|-----|-----|
| 1 | BELANGER Jasmin | 1k | la pocatiere | XX | | 5 | | | 1 | 5 | 4 |
| 2 | GAGNON Olivier | 2k+ | JJ | 5 | XX | 5 | | | 2 | 10 | 3 |
| 3 | BERTRAND Félix-Olivier | 1k | st-jean-bosco | | | XX | | | 0 | 0 | 5 |
| 4 | GUERTIN Mathis | 1k | CJVR | 5 | 10 | 10 | XX | 10 | 4 | 35 | 1 |
| 5 | GARSON Max | 1k | shidokan | 5 | 10 | 5 | | XX | 3 | 20 | 2 |

Matches/Matches

| Match | Blanc/White | | | Bleu/Blue | Rés/Res | Tmp/Tim | Code |
|-------|------------------------|---|---|------------------------|---------|---------|------|
| B-10 | GUERTIN Mathis | 4 | 5 | GARSON Max | 10 - 0 | 3:12 | IPO |
| B-11 | BELANGER Jasmin | 1 | 2 | GAGNON Olivier | 0 - 5 | 4:00 | WAZ |
| B-13 | BERTRAND Félix-Olivier | 3 | 4 | GUERTIN Mathis | 0 - 10 | 2:05 | IPO |
| B-14 | BELANGER Jasmin | 1 | 5 | GARSON Max | 0 - 5 | 4:00 | WAZ |
| B-19 | GAGNON Olivier | 2 | 3 | BERTRAND Félix-Olivier | 5 - 0 | 4:00 | WAZ |
| B-20 | BELANGER Jasmin | 1 | 4 | GUERTIN Mathis | 0 - 5 | 4:00 | WAZ |
| B-27 | BERTRAND Félix-Olivier | 3 | 5 | GARSON Max | 0 - 5 | 4:00 | WAZ |
| B-28 | GAGNON Olivier | 2 | 4 | GUERTIN Mathis | 0 - 10 | 1:56 | IPO |
| B-33 | BELANGER Jasmin | 1 | 3 | BERTRAND Félix-Olivier | 5 - 0 | 6:16 | GSW |
| B-34 | GAGNON Olivier | 2 | 5 | GARSON Max | 0 - 10 | 5:35 | HAN |

Résultats/Results

| Pos | Nom/Name |
|-----|---------------------------------------|
| 1 | GUERTIN Mathis, CJVR |
| 2 | GARSON Max, shidokan |
| 3 | GAGNON Olivier, JJ |
| 4 | BELANGER Jasmin, la pocatiere |
| 5 | BERTRAND Félix-Olivier, st-jean-bosco |

U18M -50V+

Compétiteurs/Competitors

| # | Nom/Name | Grade | Club | 1 | 2 | 3 | 4 | G/W | Pts | Pos |
|---|-----------------------|-------|------------|----|----|----|----|-----|-----|-----|
| 1 | LAURIER-SAVOIE Maxime | 3k | blainville | XX | | | | 0 | 0 | 4 |
| 2 | PAQUET Simon | 1k | Albatros | 10 | XX | | 5 | 2 | 15 | 2 |
| 3 | GANET Mathieu | 1d | zenshin | 10 | 10 | XX | 10 | 3 | 30 | 1 |
| 4 | PROTEAU Benjamin | 1k | to hakukan | 5 | | | XX | 1 | 5 | 3 |

Matches/Matches

| Match | Blanc/White | | | Bleu/Blue | Rés/Res | Tmp/Tim | Code |
|-------|-----------------------|---|---|------------------|---------|---------|------|
| D-10 | LAURIER-SAVOIE Maxime | 1 | 2 | PAQUET Simon | 0 - 10 | 1:37 | IPO |
| D-11 | GANET Mathieu | 3 | 4 | PROTEAU Benjamin | 10 - 0 | 0:45 | IPO |
| D-21 | LAURIER-SAVOIE Maxime | 1 | 3 | GANET Mathieu | 0 - 10 | 0:20 | IPO |
| D-22 | PAQUET Simon | 2 | 4 | PROTEAU Benjamin | 5 - 0 | 4:00 | WAZ |
| D-30 | LAURIER-SAVOIE Maxime | 1 | 4 | PROTEAU Benjamin | 0 - 5 | 4:00 | WAZ |
| D-31 | PAQUET Simon | 2 | 3 | GANET Mathieu | 0 - 10 | 3:13 | IPO |

Résultats/Results

| Pos | Nom/Name |
|-----|-----------------------------------|
| 1 | GANET Mathieu, zenshin |
| 2 | PAQUET Simon, Albatros |
| 3 | PROTEAU Benjamin, to hakukan |
| 4 | LAURIER-SAVOIE Maxime, blainville |

U18M -55V+

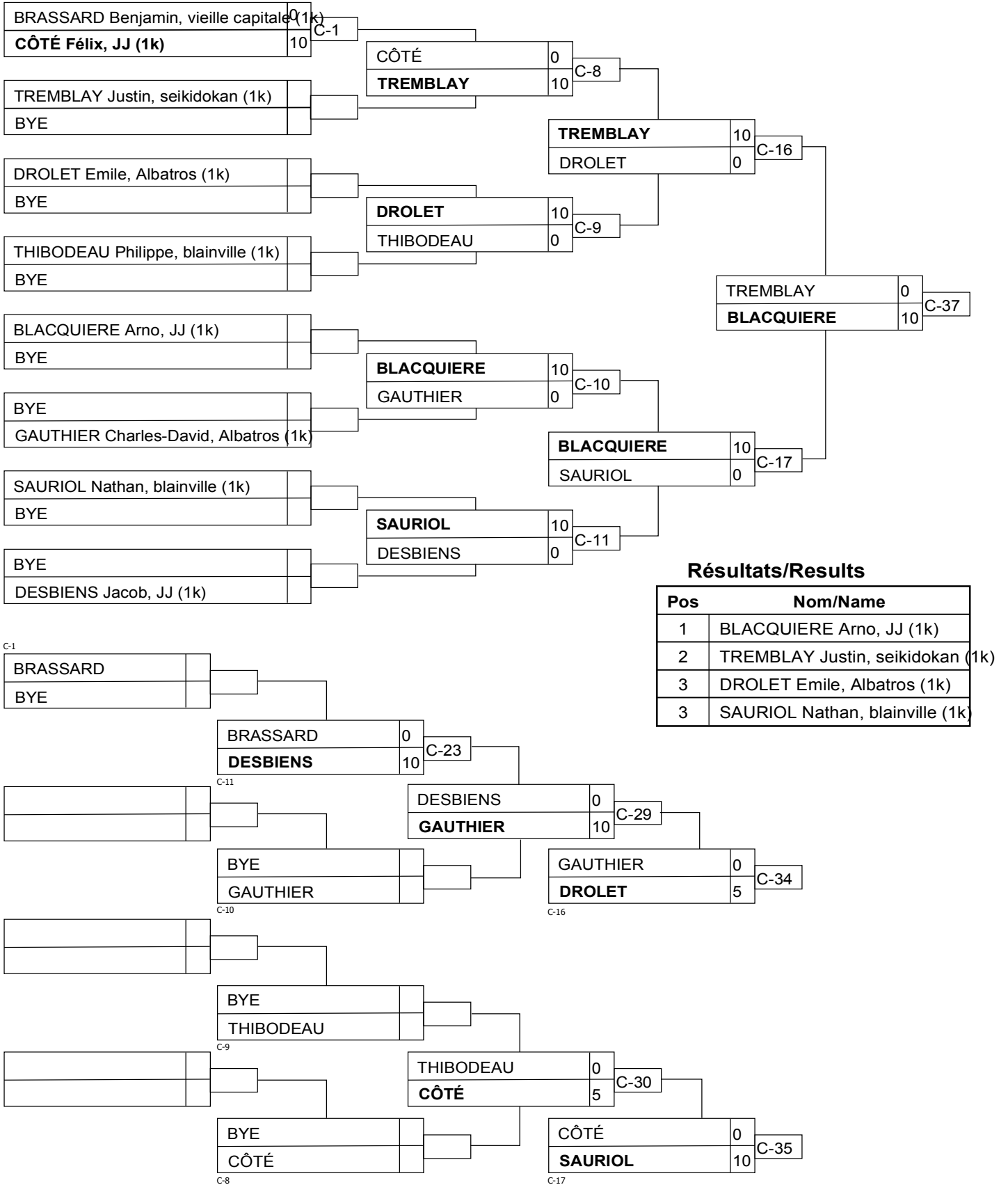

U18M -60V+

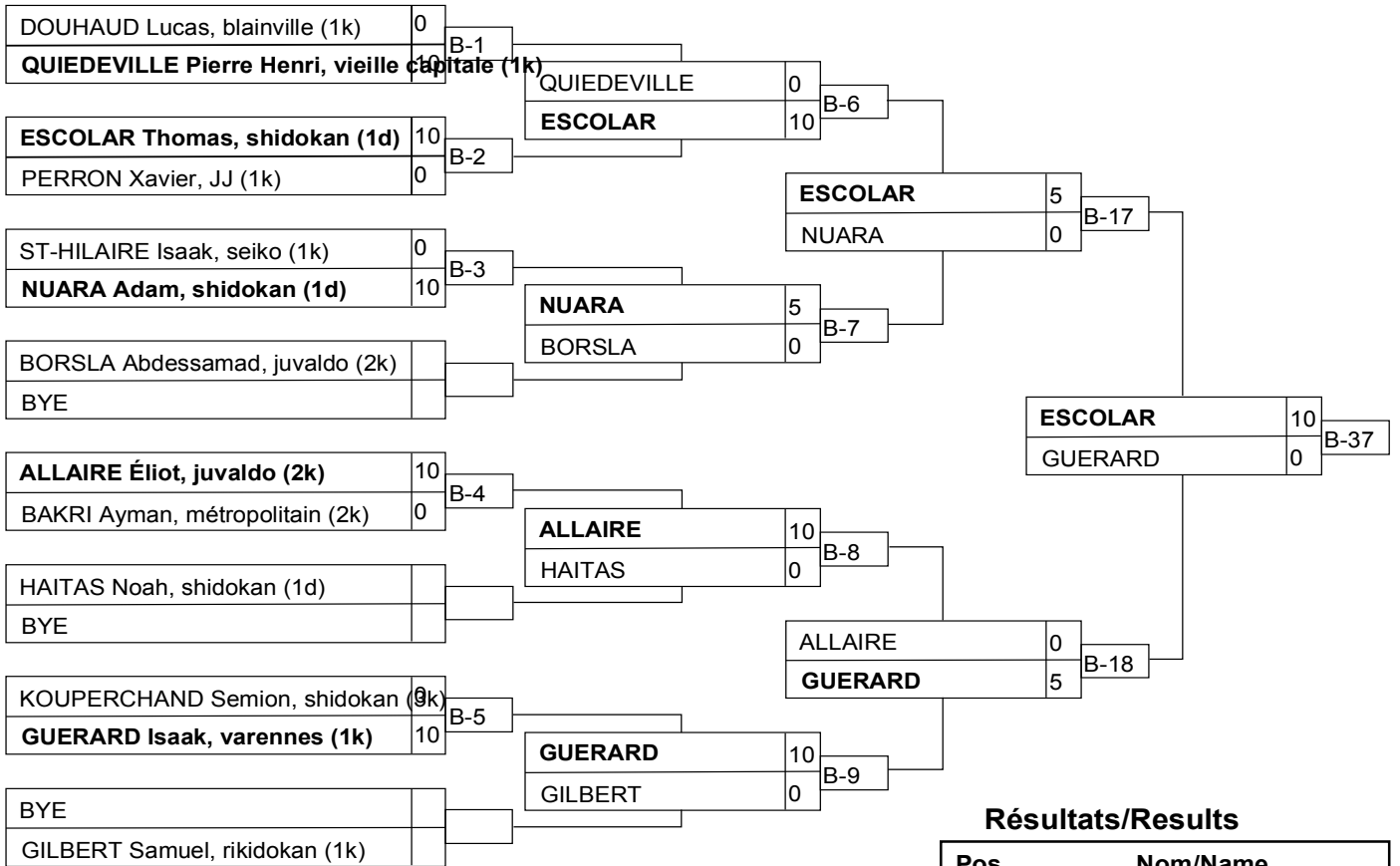

Résultats/Results

| Pos | Nom/Name |
|-----|---|
| 1 | ESCOLAR Thomas, shidokan (1d) |
| 2 | GUERARD Isaak, varennes (1k) |
| 3 | NUARA Adam, shidokan (1d) |
| 3 | QUIEDEVILLE Pierre Henri, vieille capitale (1k) |

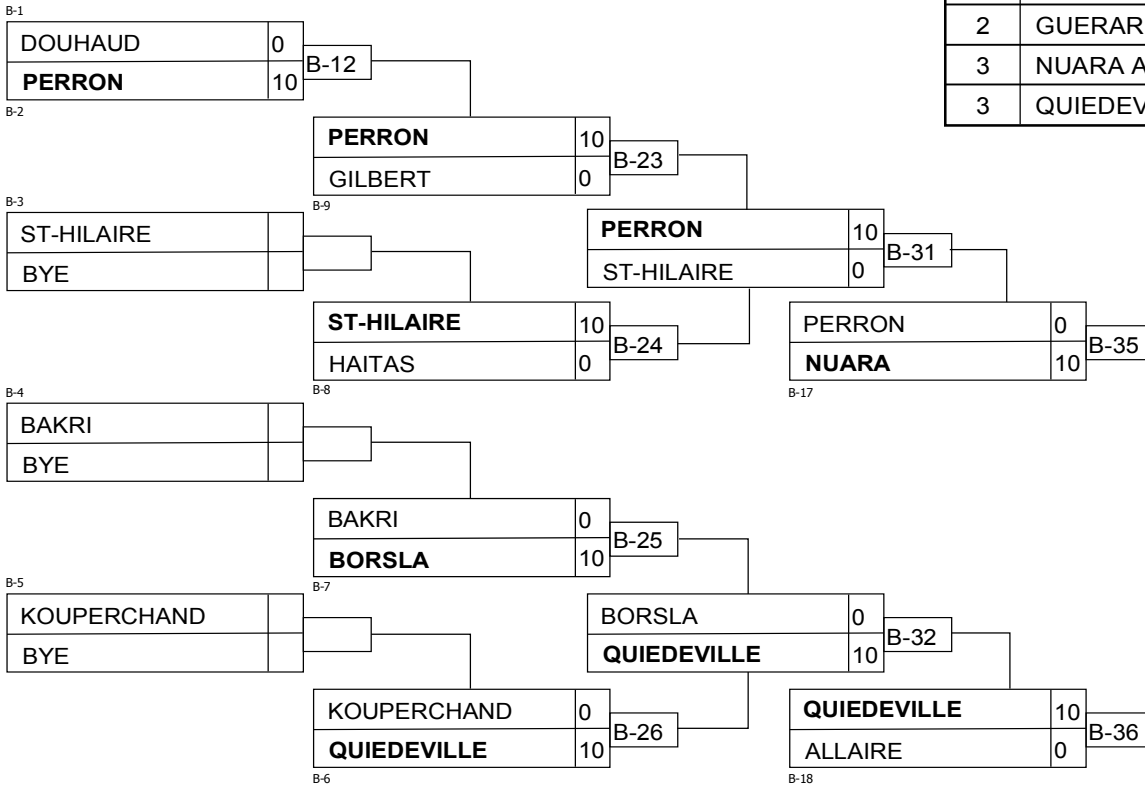

U18M -66V+

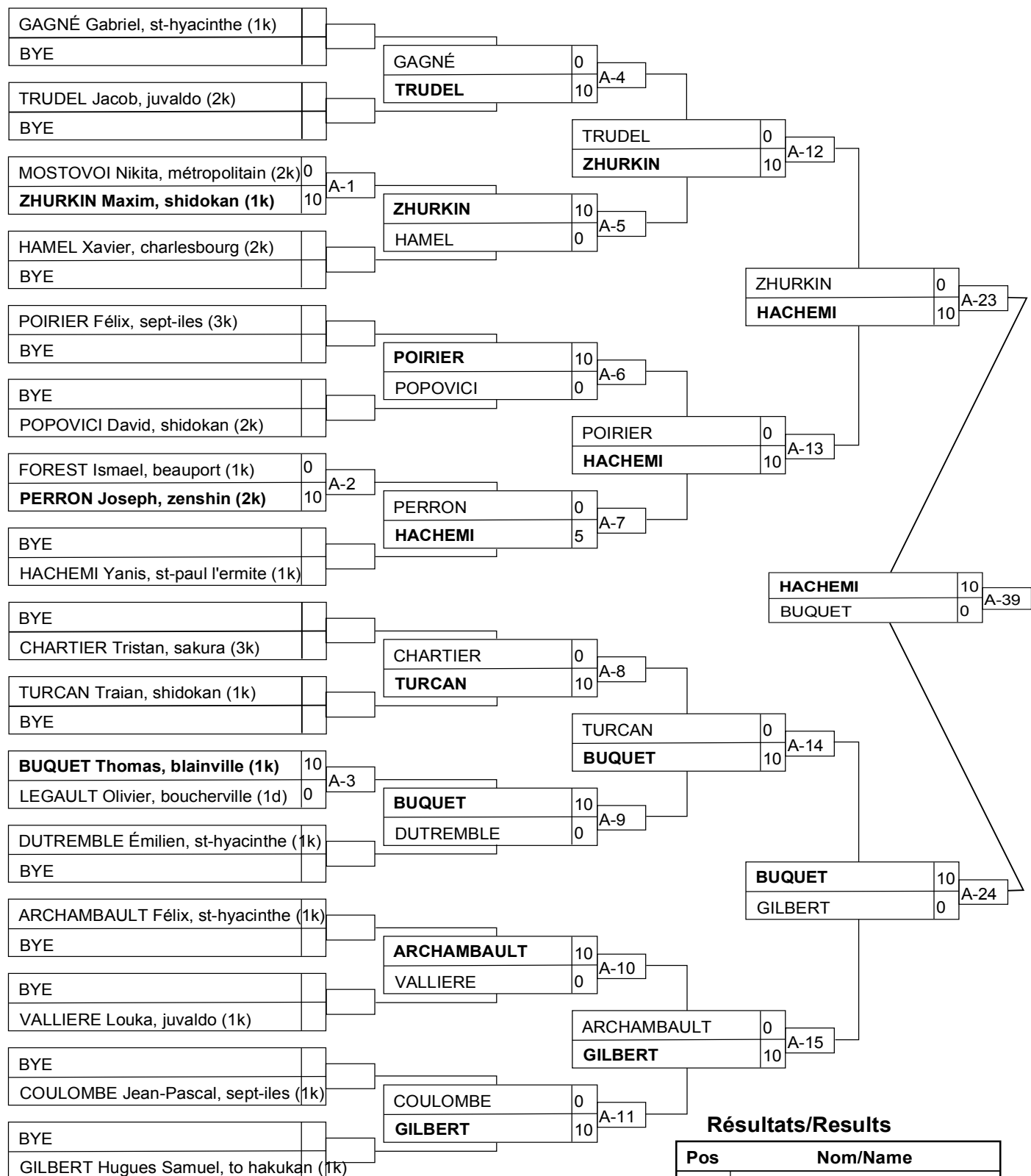

Résultats/Results

| Pos | Nom/Name |
|-----|--------------------------------------|
| 1 | HACHEMI Yanis, st-paul l'ermite (1k) |
| 2 | BUQUET Thomas, blainville (1k) |
| 3 | ZHURKIN Maxim, shidokan (1k) |
| 3 | LEGAULT Olivier, boucherville (1d) |

U18M -66V+

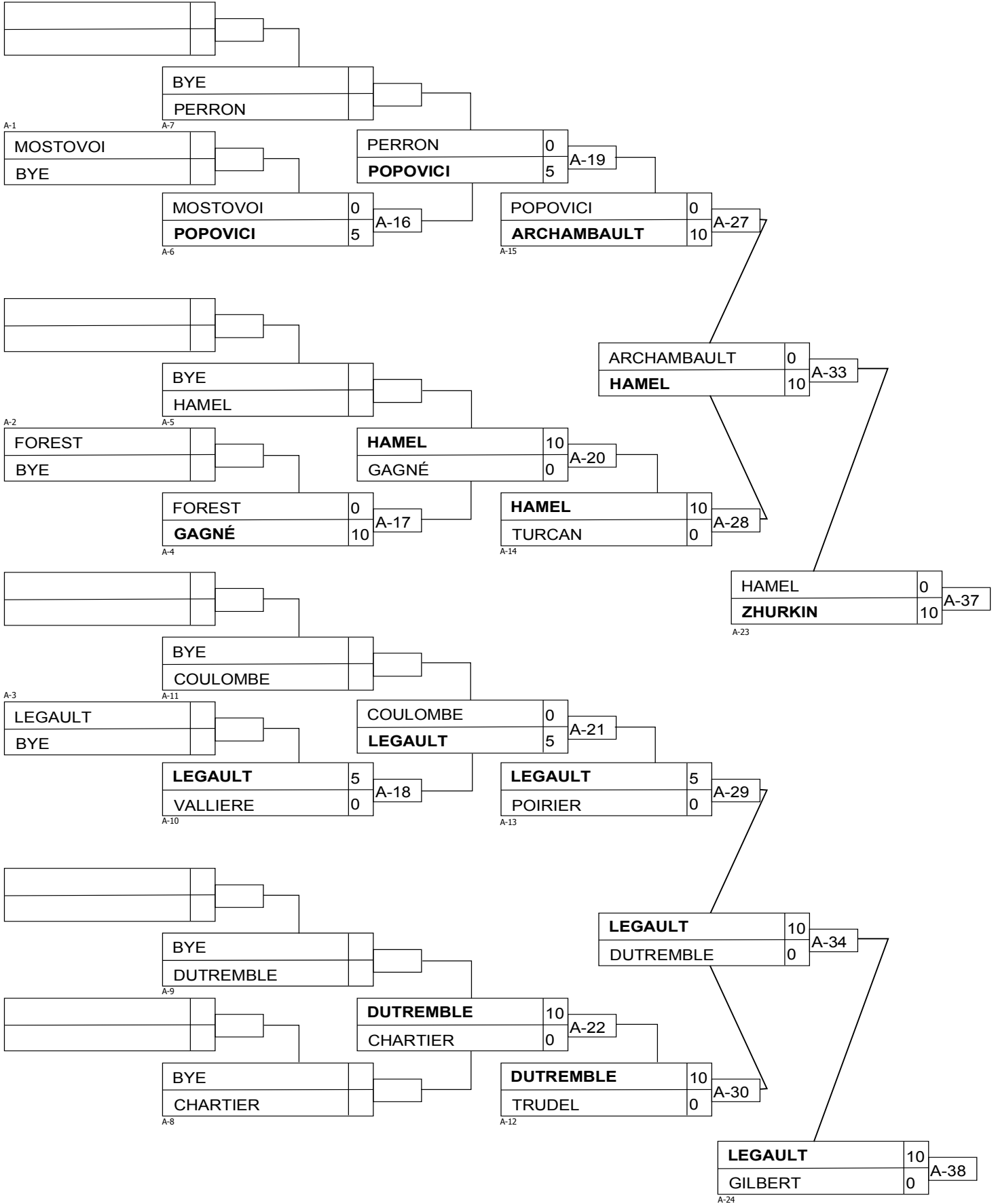

U18M -73V+

Compétiteurs/Competitors A

| # | Nom/Name | Grade | Club | 1 | 2 | 3 | G/W | Pts | Pos |
|---|------------------|-------|--------------|----|----|----|-----|-----|-----|
| 1 | ST-JEAN Jacob | 1d | boucherville | XX | 10 | 10 | 2 | 20 | 1 |
| 2 | GAULIN Guillaume | 1k | juvaldo | | XX | 5 | 1 | 5 | 2 |
| 3 | GOUIN Michel | 1k | blainville | | | XX | 0 | 0 | 3 |

Matches/Matches A

| Match | Blanc/White | | | Bleu/Blue | Rés/Res | Tmp/Tim | Code |
|-------|------------------|---|---|------------------|---------|---------|------|
| D-8 | ST-JEAN Jacob | 1 | 2 | GAULIN Guillaume | 10 - 0 | 0:52 | IPO |
| D-19 | ST-JEAN Jacob | 1 | 3 | GOUIN Michel | 10 - 0 | 1:31 | IPO |
| D-28 | GAULIN Guillaume | 2 | 3 | GOUIN Michel | 5 - 0 | 4:00 | WAZ |

Compétiteurs/Competitors B

| # | Nom/Name | Grade | Club | 4 | 5 | 6 | G/W | Pts | Pos |
|---|-------------------|-------|--------------|----|----|----|-----|-----|-----|
| 4 | GAMACHE Vincent | 1k | st-hyacinthe | XX | | | 0 | 0 | 3 |
| 5 | LAPORTE Jérémie | 1k | port-cartier | 10 | XX | 10 | 2 | 20 | 1 |
| 6 | DESROULEAUX Sasha | 1k | CJBC | 10 | | XX | 1 | 10 | 2 |

Matches/Matches B

| Match | Blanc/White | | | Bleu/Blue | Rés/Res | Tmp/Tim | Code |
|-------|-----------------|---|---|-------------------|---------|---------|------|
| D-9 | GAMACHE Vincent | 4 | 5 | LAPORTE Jérémie | 0 - 10 | 1:47 | IPO |
| D-20 | GAMACHE Vincent | 4 | 6 | DESROULEAUX Sasha | 0 - 10 | 2:57 | KIK |
| D-29 | LAPORTE Jérémie | 5 | 6 | DESROULEAUX Sasha | 10 - 0 | 3:42 | IPO |

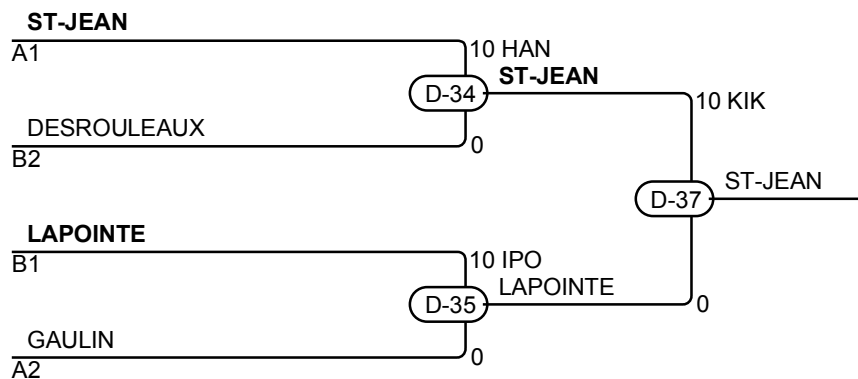

Résultats/Results

| Pos | Nom/Name |
|-----|-------------------------------|
| 1 | ST-JEAN Jacob, boucherville |
| 2 | LAPORTE Jérémie, port-cartier |
| 3 | DESROULEAUX Sasha, CJBC |
| 3 | GAULIN Guillaume, juvaldo |

U18M -81V+

Compétiteurs/Competitors

| # | Nom/Name | Grade | Club | 1 | 2 | 3 | 4 | G/W | Pts | Pos |
|---|-----------------|-------|-----------|----|----|----|----|-----|-----|-----|
| 1 | COULOMBE Justin | 1k | sept-iles | XX | | | | 0 | 0 | 4 |
| 2 | LABRIE Jérémy | 2k | sept-iles | 10 | XX | | | 1 | 10 | 3 |
| 3 | BERGERON Boris | 1k | shidokan | 10 | 10 | XX | 10 | 3 | 30 | 1 |
| 4 | LAPORTE Renaud | 1k | JJ | 10 | 10 | | XX | 2 | 20 | 2 |

Matches/Matches

| Match | Blanc/White | | | Bleu/Blue | Rés/Res | Tmp/Tim | Code |
|-------|-----------------------|---|---|-----------------------|---------|---------|------|
| C-14 | COULOMBE Justin | 1 | 2 | LABRIE Jérémy | 0 - 10 | 1:34 | IPO |
| C-15 | BERGERON Boris | 3 | 4 | LAPORTE Renaud | 10 - 0 | 1:03 | IPO |
| C-21 | COULOMBE Justin | 1 | 3 | BERGERON Boris | 0 - 10 | 2:38 | IPO |
| C-22 | LABRIE Jérémy | 2 | 4 | LAPORTE Renaud | 0 - 10 | 3:27 | IPO |
| C-27 | COULOMBE Justin | 1 | 4 | LAPORTE Renaud | 0 - 10 | 1:39 | IPO |
| C-28 | LABRIE Jérémy | 2 | 3 | BERGERON Boris | 0 - 10 | 0:19 | IPO |

Résultats/Results

| Pos | Nom/Name |
|-----|----------------------------|
| 1 | BERGERON Boris, shidokan |
| 2 | LAPORTE Renaud, JJ |
| 3 | LABRIE Jérémy, sept-iles |
| 4 | COULOMBE Justin, sept-iles |

U18M -90V+

Compétiteurs/Competitors

| # | Nom/Name | Grade | Club | 1 | 2 | 3 | 4 | 5 | G/W | Pts | Pos |
|---|------------------|-------|--------------|----|----|----|----|----|-----|-----|-----|
| 1 | LEVESQUE Nicolas | 2k | port-cartier | XX | | | 10 | 10 | 2 | 20 | 3 |
| 2 | CHAMPAGNE Jérôme | 1k | varenes | 10 | XX | 10 | 10 | 10 | 4 | 40 | 1 |
| 3 | VALLIERE Simon | 1k | juvaldo | 10 | | XX | 10 | 10 | 3 | 30 | 2 |
| 4 | KHAVERI Sajjad | 2k | donini | | | | XX | 10 | 1 | 10 | 4 |
| 5 | SEYE Norman | 1k | olympique | | | | | XX | 0 | 0 | 5 |

Matches/Matches

| Match | Blanc/White | | | Bleu/Blue | Rés/Res | Tmp/Tim | Code |
|-------|-------------------------|---|---|-------------------------|---------|---------|------|
| D-1 | KHAVERI Sajjad | 4 | 5 | SEYE Norman | 10 - 0 | 0:28 | IPO |
| D-2 | LEVESQUE Nicolas | 1 | 2 | CHAMPAGNE Jérôme | 0 - 10 | 3:32 | HAN |
| D-6 | VALLIERE Simon | 3 | 4 | KHAVERI Sajjad | 10 - 0 | 0:17 | KIK |
| D-7 | LEVESQUE Nicolas | 1 | 5 | SEYE Norman | 10 - 0 | 1:00 | IPO |
| D-12 | CHAMPAGNE Jérôme | 2 | 3 | VALLIERE Simon | 10 - 0 | 2:31 | IPO |
| D-13 | LEVESQUE Nicolas | 1 | 4 | KHAVERI Sajjad | 10 - 0 | 0:01 | FUS |
| D-17 | VALLIERE Simon | 3 | 5 | SEYE Norman | 10 - 0 | 1:23 | IPO |
| D-18 | CHAMPAGNE Jérôme | 2 | 4 | KHAVERI Sajjad | 10 - 0 | 0:01 | FUS |
| D-26 | LEVESQUE Nicolas | 1 | 3 | VALLIERE Simon | 0 - 10 | 0:34 | IPO |
| D-27 | CHAMPAGNE Jérôme | 2 | 5 | SEYE Norman | 10 - 0 | 0:18 | IPO |

Résultats/Results

| Pos | Nom/Name |
|-----|--------------------------------|
| 1 | CHAMPAGNE Jérôme, varenes |
| 2 | VALLIERE Simon, juvaldo |
| 3 | LEVESQUE Nicolas, port-cartier |
| 4 | KHAVERI Sajjad, donini |
| 5 | SEYE Norman, olympique |