

U18 F48

Compétiteurs

#	Nom	Grade	Club	1	2	3	4	5	Vic.	Pts	Pos
1	ROY Léa	1 Kyu	QC	XX	5	10	10		3	25	2
2	SCREMIN Sabrina	1 Kyu	QC		XX	10			1	10	4
3	BOISVERT Jalexina	1 Kyu	QC			XX			0	0	5
4	OUELLETTE Yzabelle	Shodan	NB		10	10	XX		2	20	3
5	NEMETH VIRGINIA	Shodan	AB	10	10	10	10	XX	4	40	1

Matches

Match	Blanc			Bleu	Résultat	Temp	Code
A-15	OUELLETTE Yzabelle	4	5	NEMETH VIRGINIA	0 - 10	0:49	IPO
A-16	ROY Léa	1	2	SCREMIN Sabrina	5 - 0	4:00	YUK
A-26	BOISVERT Jalexina	3	4	OUELLETTE Yzabelle	0 - 10	1:56	IPO
A-27	ROY Léa	1	5	NEMETH VIRGINIA	0 - 10	0:45	IPO
A-30	SCREMIN Sabrina	2	3	BOISVERT Jalexina	10 - 0	1:55	IPO
A-31	ROY Léa	1	4	OUELLETTE Yzabelle	10 - 0	3:12	WIP
A-44	BOISVERT Jalexina	3	5	NEMETH VIRGINIA	0 - 10	0:09	IPO
A-45	SCREMIN Sabrina	2	4	OUELLETTE Yzabelle	0 - 10	0:18	IPO
A-57	ROY Léa	1	3	BOISVERT Jalexina	10 - 0	0:00	FUS
A-58	SCREMIN Sabrina	2	5	NEMETH VIRGINIA	0 - 10	0:24	IPO

Résultats

Pos	Nom
1	NEMETH VIRGINIA, AB
2	ROY Léa , QC
3	OUELLETTE Yzabelle, NB
4	SCREMIN Sabrina, QC
5	BOISVERT Jalexina, QC

U18 F52

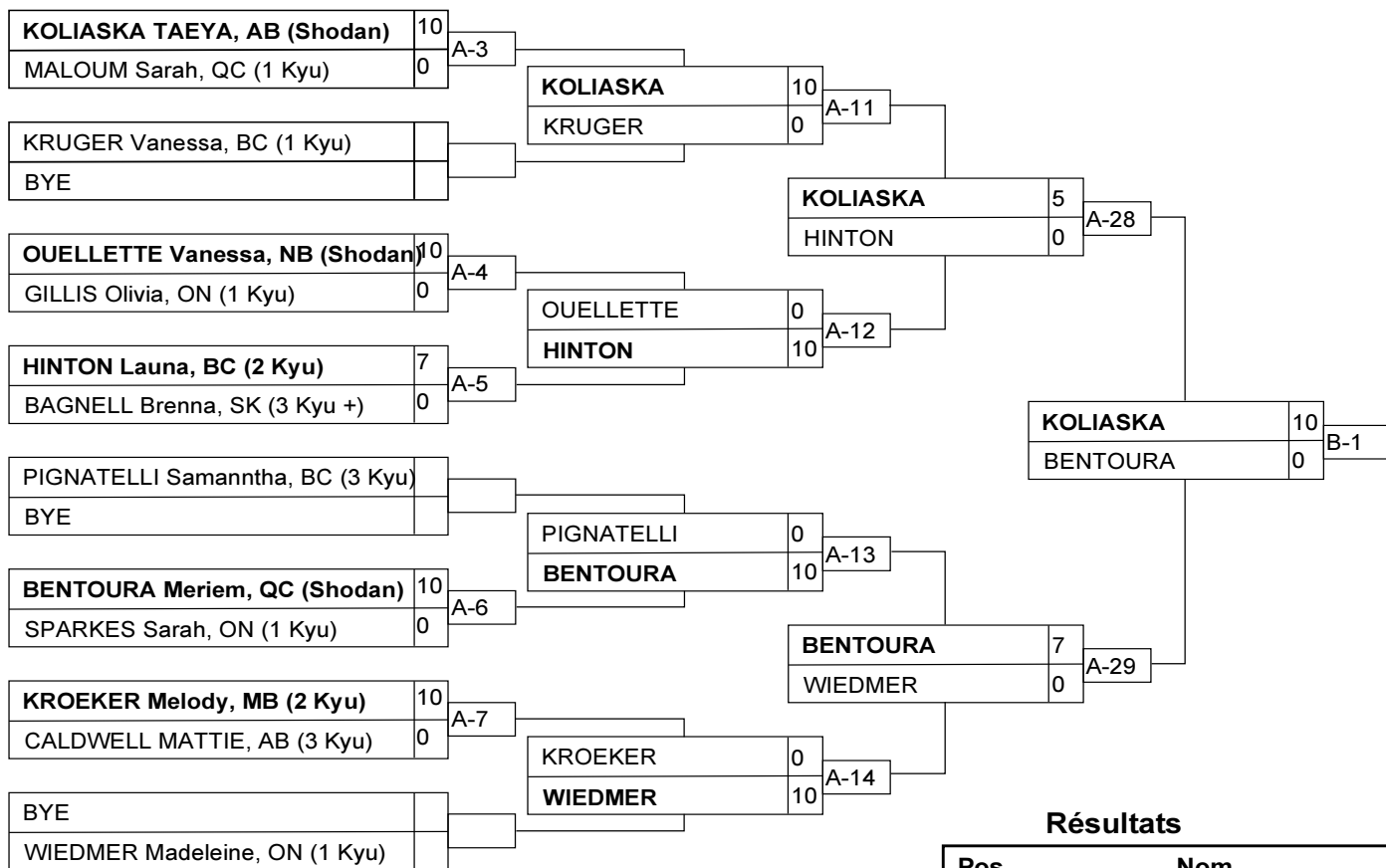

Résultats

Pos	Nom
1	KOLIASKA TAEYA, AB (Shodan)
2	BENTOURA Meriem, QC (Shodan)
3	MALOUM Sarah, QC (1 Kyu)
3	WIEDMER Madeleine, ON (1 Kyu)

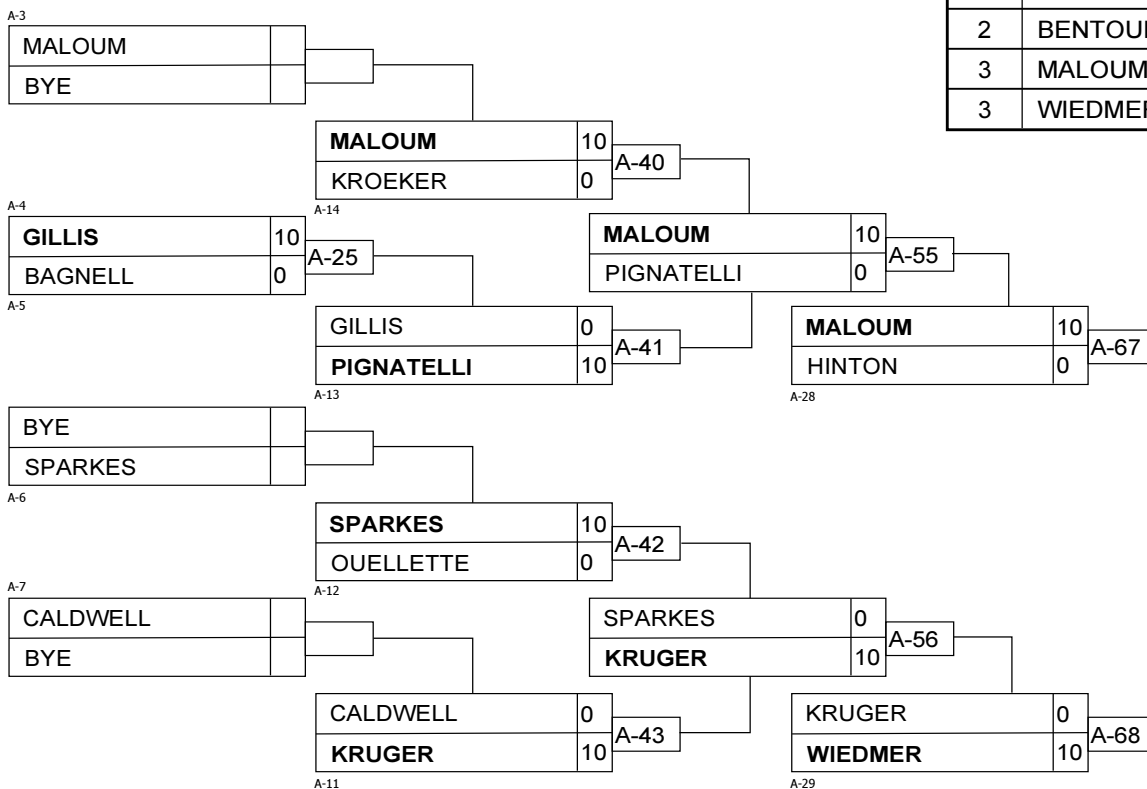

U18 F57

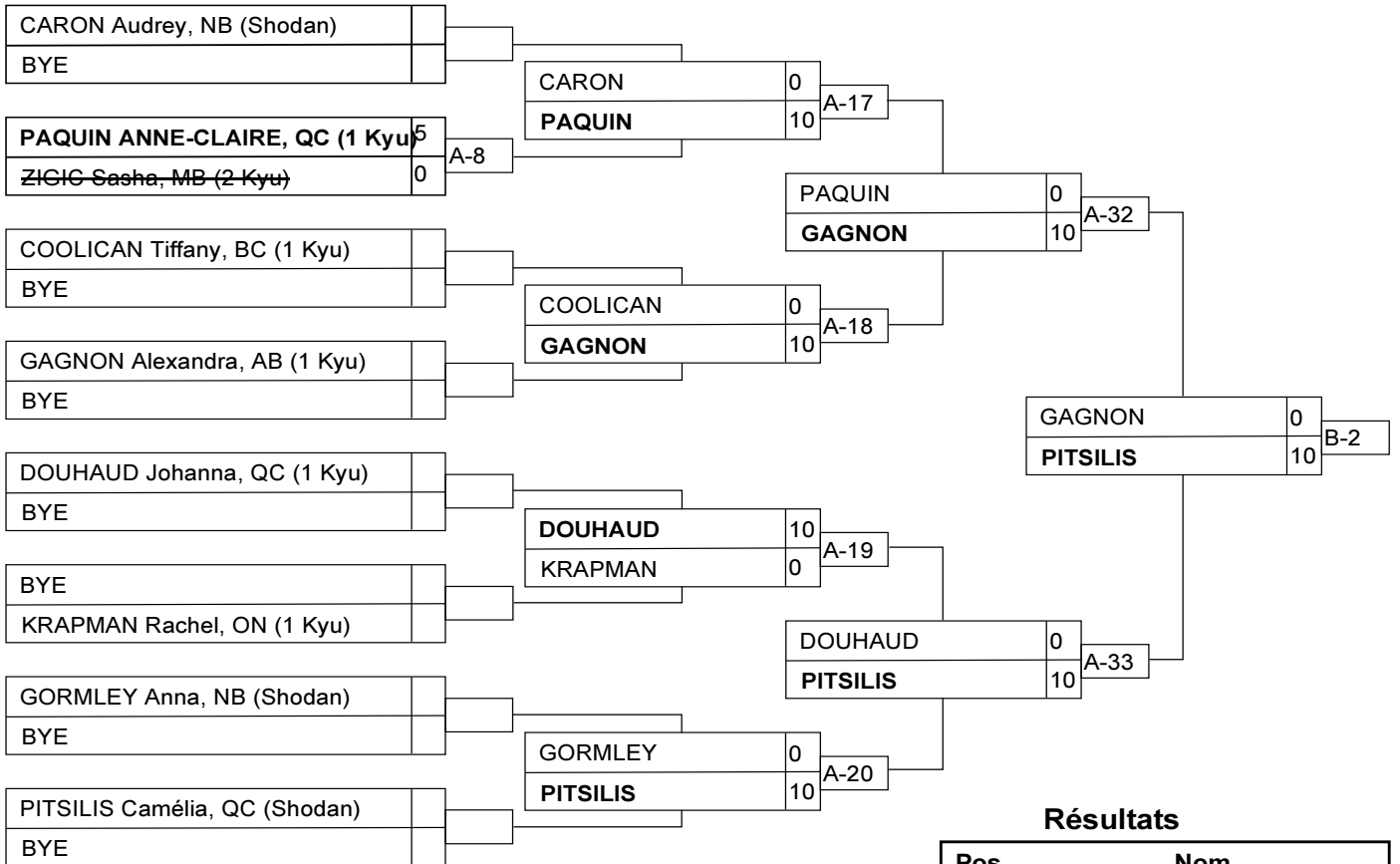

Résultats

Pos	Nom
1	PITSILIS Camélia, QC (Shodan)
2	GAGNON Alexandra, AB (1 Kyu)
3	PAQUIN ANNE-CLAIRE, QC (1 Kyu)
3	DOUHAUD Johanna, QC (1 Kyu)

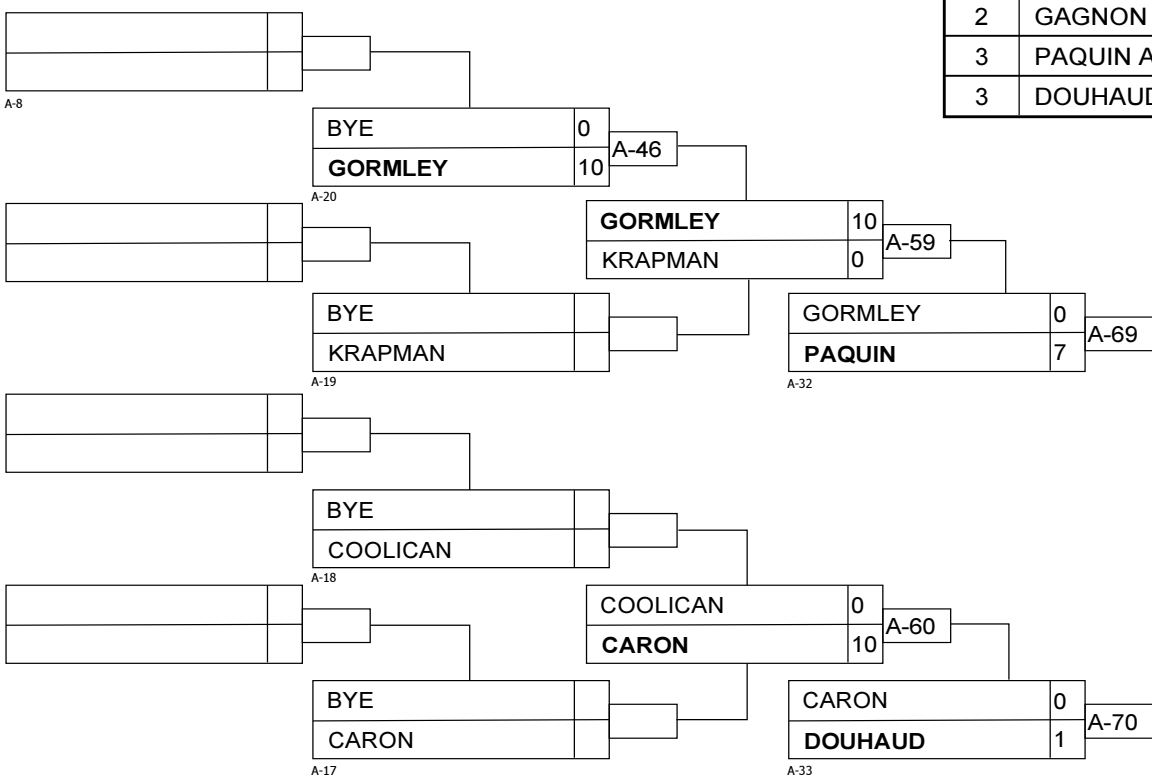

U18 F63

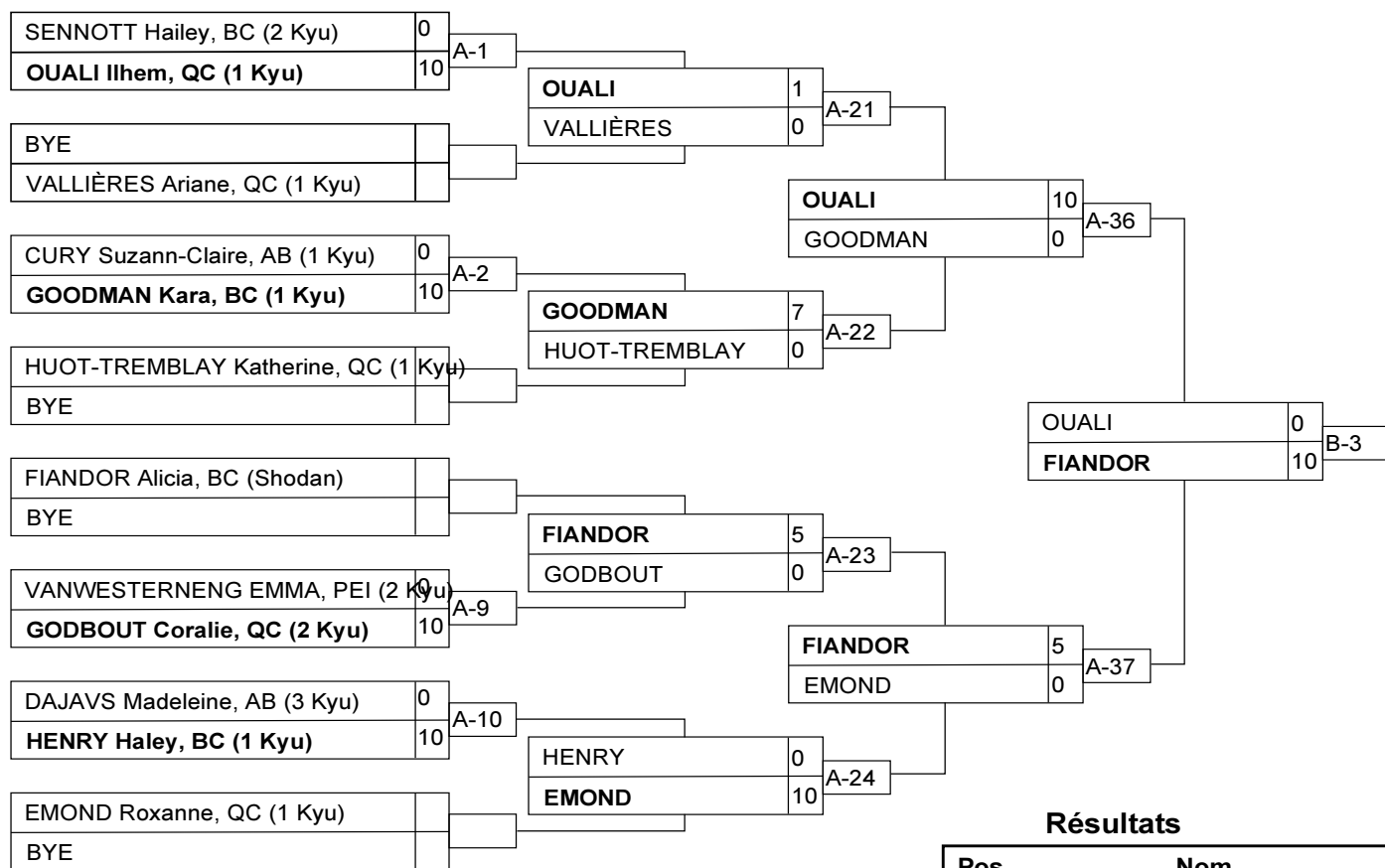

Résultats

Pos	Nom
1	FIANDOR Alicia, BC (Shodan)
2	OUALI Ilhem, QC (1 Kyu)
3	GODBOUT Coralie, QC (2 Kyu)
3	EMOND Roxanne, QC (1 Kyu)

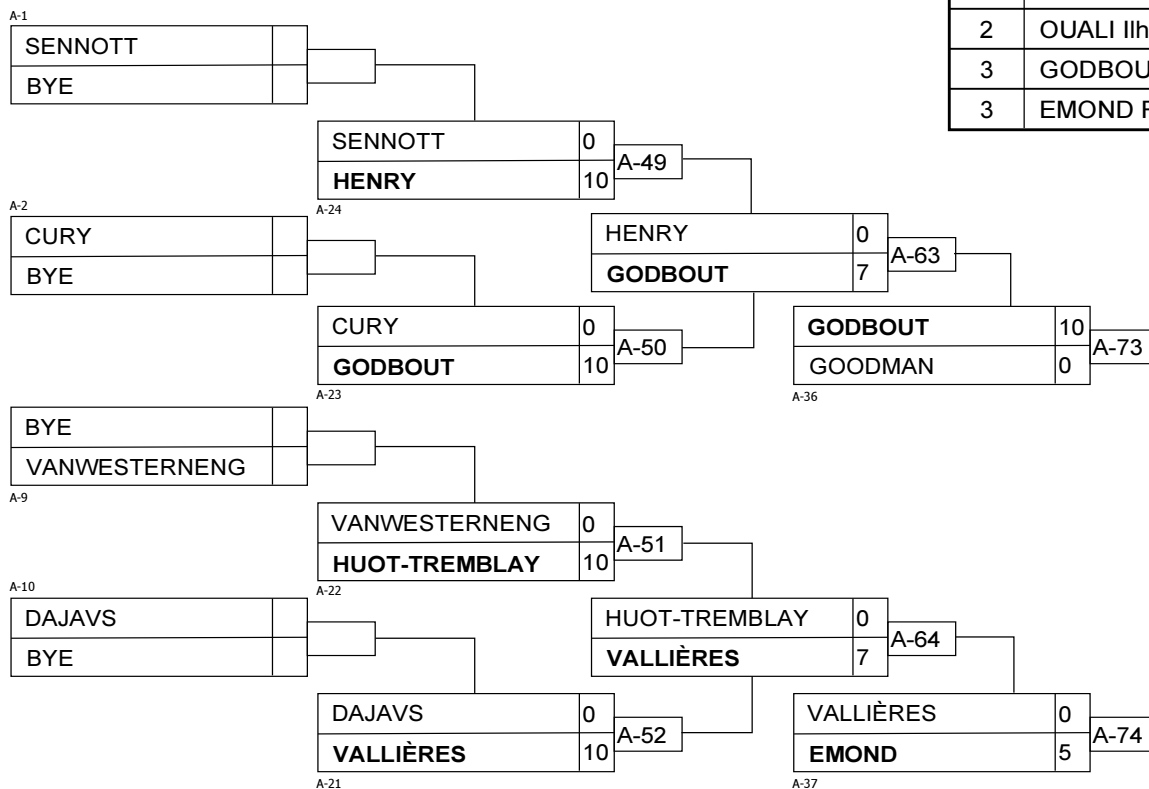

U18 F70

Compétiteurs A

#	Nom	Grade	Club	1	2	3	Vic.	Pts	Pos
1	ENDEAN Morgan	1 Kyu	BC	XX			0	0	3
2	NEUMAN Megan	2 Kyu	SK	10	XX		1	10	2
3	CHIRILA Maria-Carla	1 Kyu	QC	10	10	XX	2	20	1

Matches A

Match	Blanc	Bleu	Résultat	Temp	Code
A-34	ENDEAN Morgan	1 2 NEUMAN Megan	0 - 10	0:19	IPO
A-47	ENDEAN Morgan	1 3 CHIRILA Maria-Carla	0 - 10	0:42	WIP
A-61	NEUMAN Megan	2 3 CHIRILA Maria-Carla	0 - 10	1:37	WIP

Compétiteurs B

#	Nom	Grade	Club	4	5	6	Vic.	Pts	Pos
4	ZAWADZKI Nikki	3 Kyu	BC	XX			0	0	3
5	LÉVESQUE Ariane	1 Kyu	QC	10	XX	10	2	20	1
6	VENUGOPAL Madison	1 Kyu	NB	10		XX	1	10	2

Matches B

Match	Blanc	Bleu	Résultat	Temp	Code
A-35	ZAWADZKI Nikki	4 5 LÉVESQUE Ariane	0 - 10	0:10	IPO
A-48	ZAWADZKI Nikki	4 6 VENUGOPAL Madison	0 - 10	0:10	IPO
A-62	LÉVESQUE Ariane	5 6 VENUGOPAL Madison	10 - 0	1:09	IPO

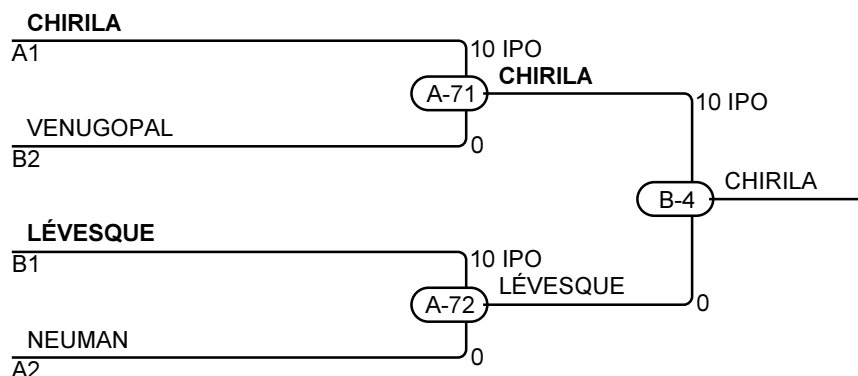

Résultats

Pos	Nom
1	CHIRILA Maria-Carla, QC
2	LÉVESQUE Ariane, QC
3	VENUGOPAL Madison, NB
3	NEUMAN Megan, SK

U18 F70+

Compétiteurs

#	Nom	Grade	Club	1	2	3	4	Vic.	Pts	Pos
1	DARLOW ANNABELLE	3 Kyu	AB	XX		10	7	2	17	2
2	PERKS SARAH	1 Kyu	AB	7	XX	10		2	17	1
3	SHEA KAMRYN	1 Kyu	PEI			XX	10	1	10	3
4	SYNNOT Josianne	2 Kyu	QC		10		XX	1	10	4

Matches

Match	Blanc			Bleu	Résultat	Temp	Code
A-38	DARLOW ANNABELLE	1	2	PERKS SARAH	0 - 7	4:00	WAZ
A-39	SHEA KAMRYN	3	4	SYNNOT Josianne	10 - 0	2:40	WIP
A-53	DARLOW ANNABELLE	1	3	SHEA KAMRYN	10 - 0	3:34	IPO
A-54	PERKS SARAH	2	4	SYNNOT Josianne	0 - 10	3:06	HAN
A-65	DARLOW ANNABELLE	1	4	SYNNOT Josianne	7 - 0	4:00	WAZ
A-66	PERKS SARAH	2	3	SHEA KAMRYN	10 - 0	4:00	IPO

Résultats

Pos	Nom
1	PERKS SARAH, AB
2	DARLOW ANNABELLE, AB
3	SHEA KAMRYN, PEI
4	SYNNOT Josianne, QC

U18 M46

Compétiteurs

#	Nom	Grade	Club	1	2	1	2	1	2	Vic.	Pts	Pos
1	NUARA Adam	1 Kyu	QC	XX		XX		XX		0	0	2
2	DAMETTO Christian	1 Kyu	ON	10	XX	5	XX		XX	2	15	1

Matches

Match	Blanc			Bleu	Résultat	Temp	Code
B-48	NUARA Adam	1	2	DAMETTO Christian	0 - 10	1:34	WIP
B-59	NUARA Adam	1	2	DAMETTO Christian	0 - 5	4:00	YUK
B-68	NUARA Adam	1	2	DAMETTO Christian			

Résultats

Pos	Nom
1	DAMETTO Christian, ON
2	NUARA Adam, QC

U18 M50

Compétiteurs

#	Nom	Grade	Club	1	2	3	4	5	Vic.	Pts	Pos
1	THORNER Jackson	1 Kyu	ON	XX					0	0	5
2	GAUTHIER-DRAPEAU Antoine	1 Kyu	QC	10	XX	10			2	20	3
3	PERELMUTOV Innokentii-Kevin	3 Kyu	QC	10		XX			1	10	4
4	SAPENOV Aidos	1 Kyu	ON	10	10	10	XX	10	4	40	1
5	VANDERSANDEN Erik	1 Kyu	ON	10	10	10		XX	3	30	2

Matches

Match	Blanc			Bleu	Résultat	Temp	Code
B-36	SAPENOV Aidos	4	5	VANDERSANDEN Erik	10 - 0	0:27	IPO
B-37	THORNER Jackson	1	2	GAUTHIER-DRAPEAU Antoine	0 - 10	3:22	WIP
B-42	PERELMUTOV Innokentii-Kevin	3	4	SAPENOV Aidos	0 - 10	1:57	IPO
B-43	THORNER Jackson	1	5	VANDERSANDEN Erik	0 - 10	1:58	IPO
B-51	GAUTHIER-DRAPEAU Antoine	2	3	PERELMUTOV Innokentii-Kevin	10 - 0	5:22	GSI
B-52	THORNER Jackson	1	4	SAPENOV Aidos	0 - 10	1:22	WIP
B-62	PERELMUTOV Innokentii-Kevin	3	5	VANDERSANDEN Erik	0 - 10	0:22	IPO
B-63	GAUTHIER-DRAPEAU Antoine	2	4	SAPENOV Aidos	0 - 10	0:50	IPO
B-71	THORNER Jackson	1	3	PERELMUTOV Innokentii-Kevin	0 - 10	1:40	WIP
B-72	GAUTHIER-DRAPEAU Antoine	2	5	VANDERSANDEN Erik	0 - 10	4:32	GSI

Résultats

Pos	Nom
1	SAPENOV Aidos, ON
2	VANDERSANDEN Erik, ON
3	GAUTHIER-DRAPEAU Antoine, QC
4	PERELMUTOV Innokentii-Kevin, QC
5	THORNER Jackson, ON

U18 M55

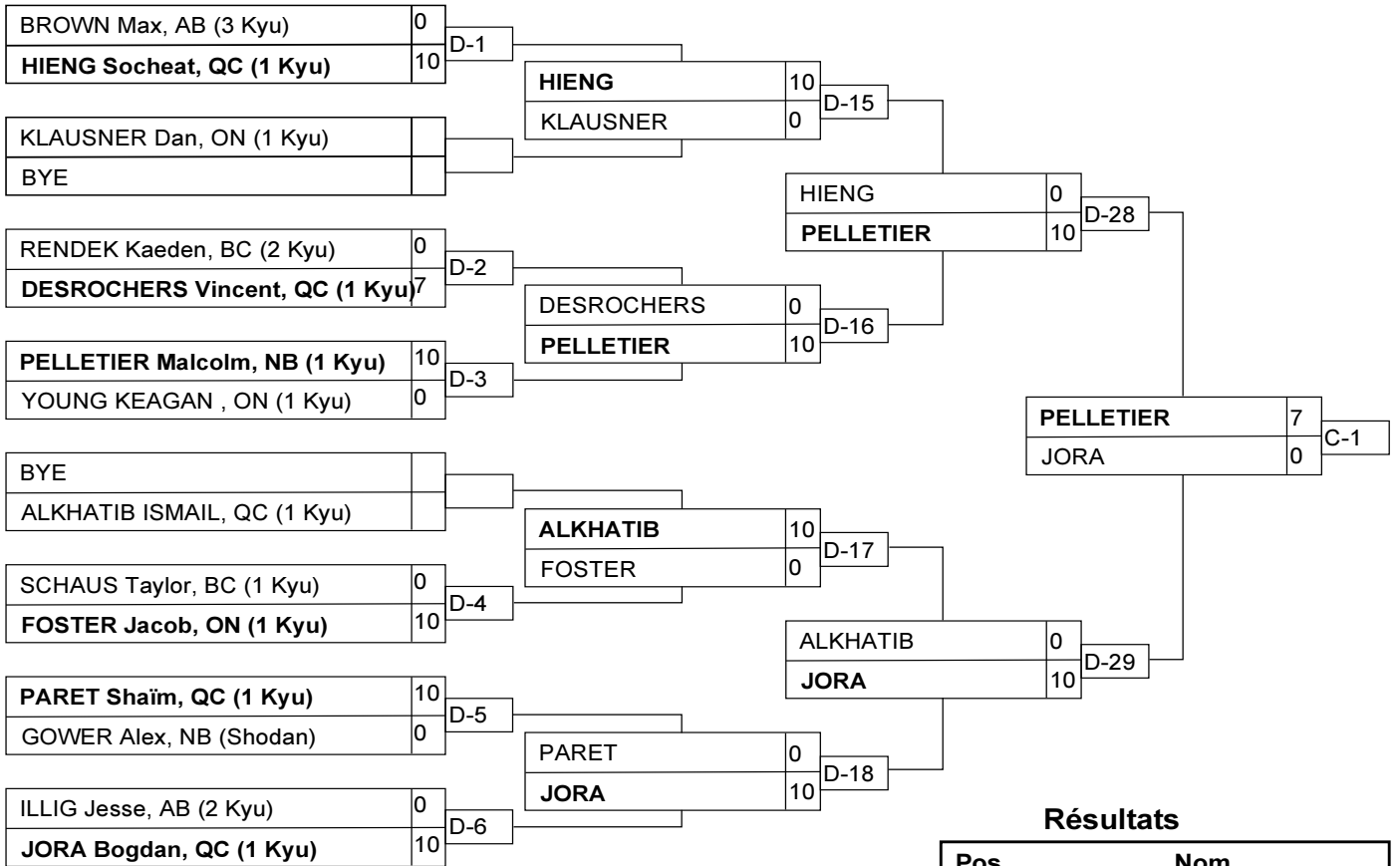

Résultats

Pos	Nom
1	PELLETIER Malcolm, NB (1 Kyu)
2	JORA Bogdan, QC (1 Kyu)
3	PARET Shaïm, QC (1 Kyu)
3	ALKHATIB ISMAIL, QC (1 Kyu)

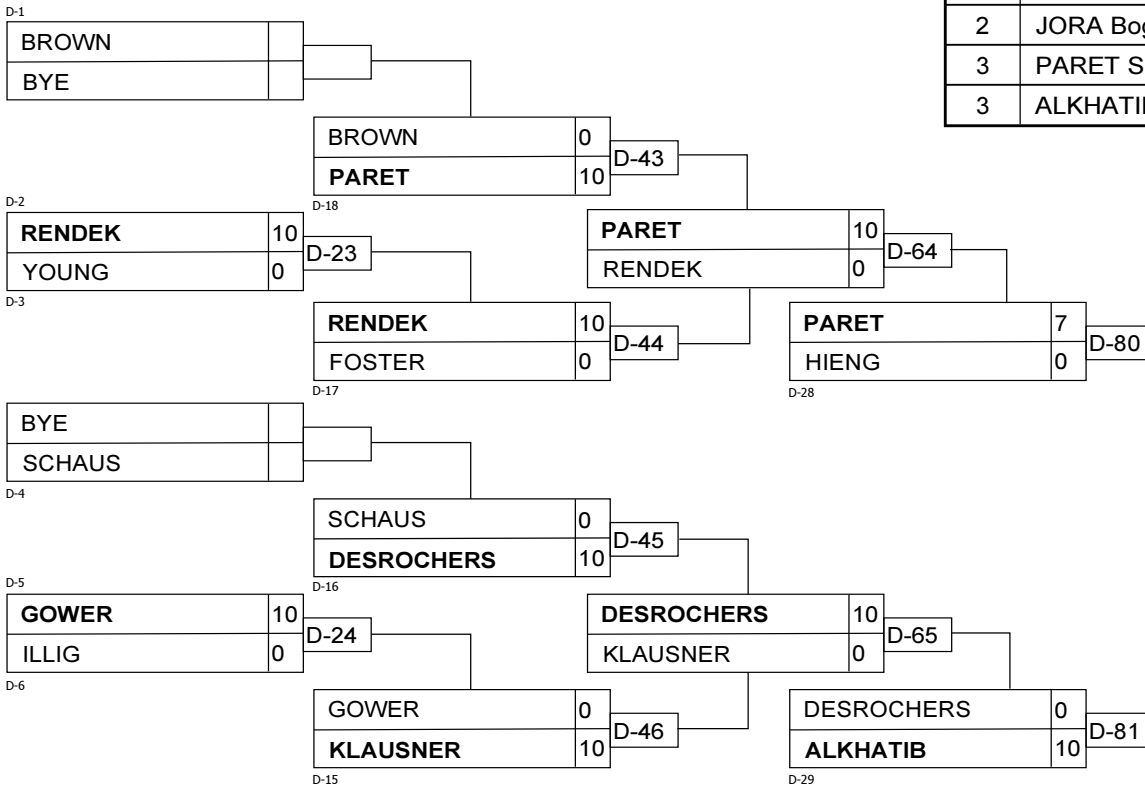

U18 M60

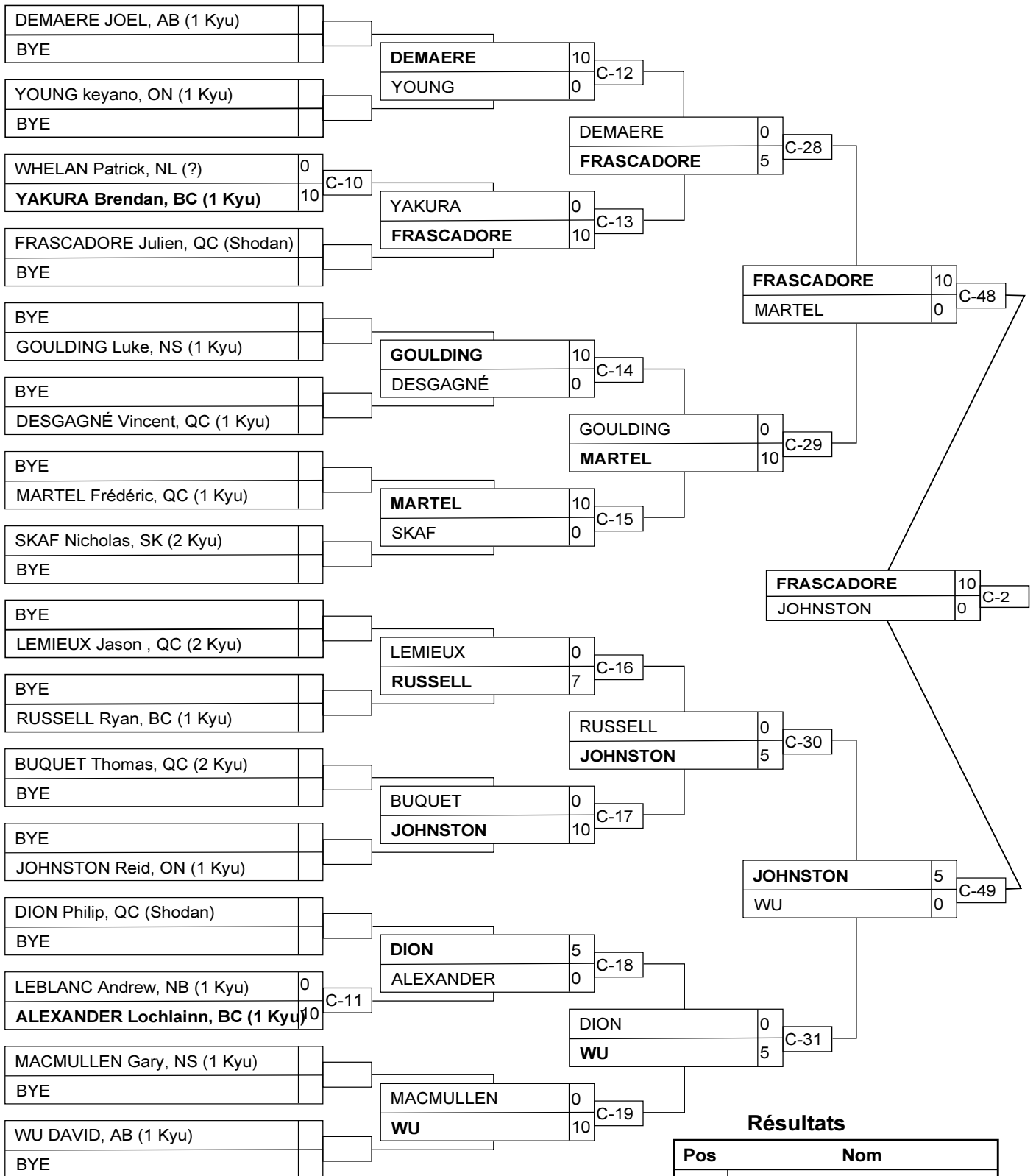

Résultats

Pos	Nom
1	FRASCADORE Julien, QC (Shodan)
2	JOHNSTON Reid, ON (1 Kyu)
3	DION Philip, QC (Shodan)
3	WU DAVID, AB (1 Kyu)

U18 M60

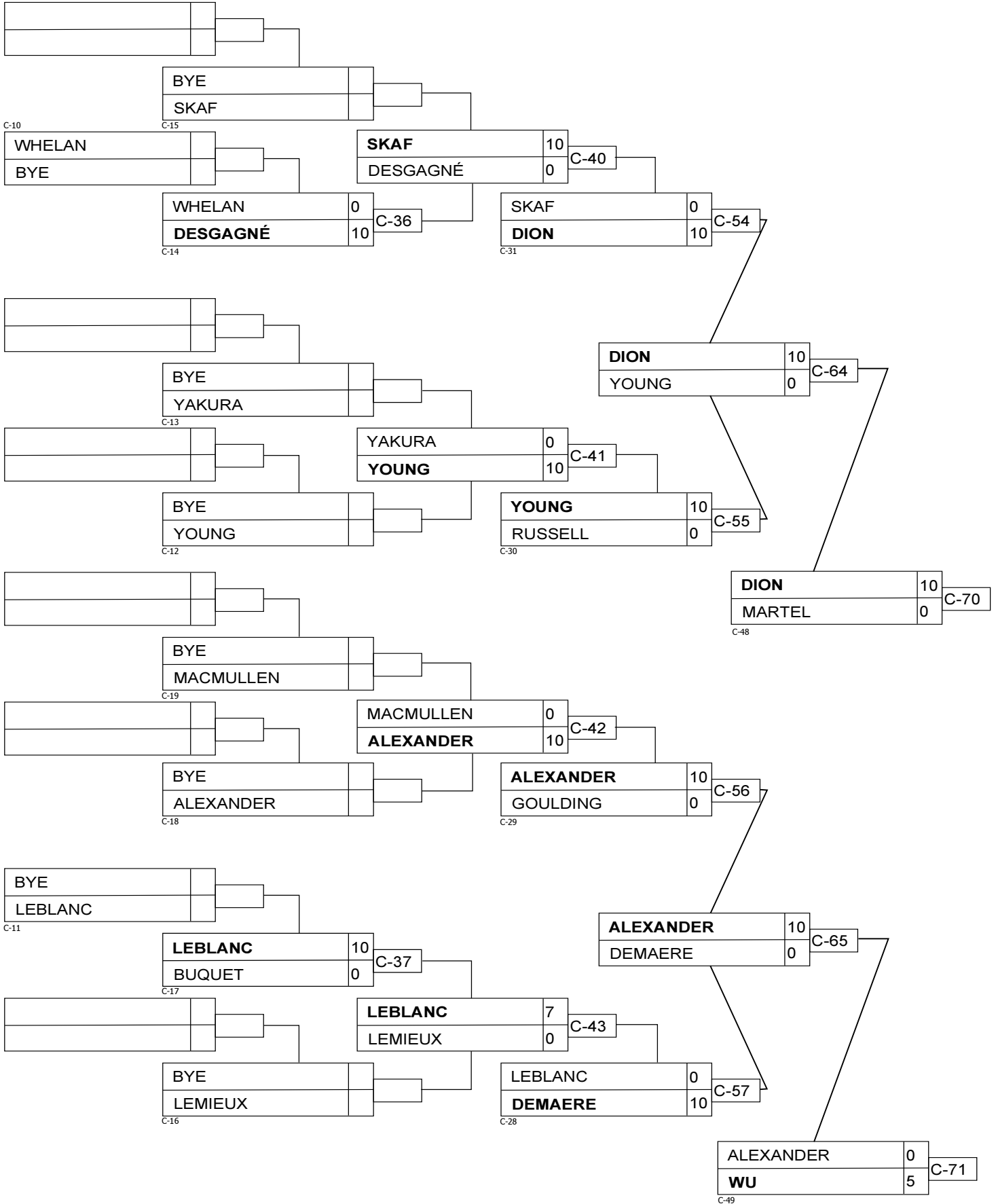

U18 M66

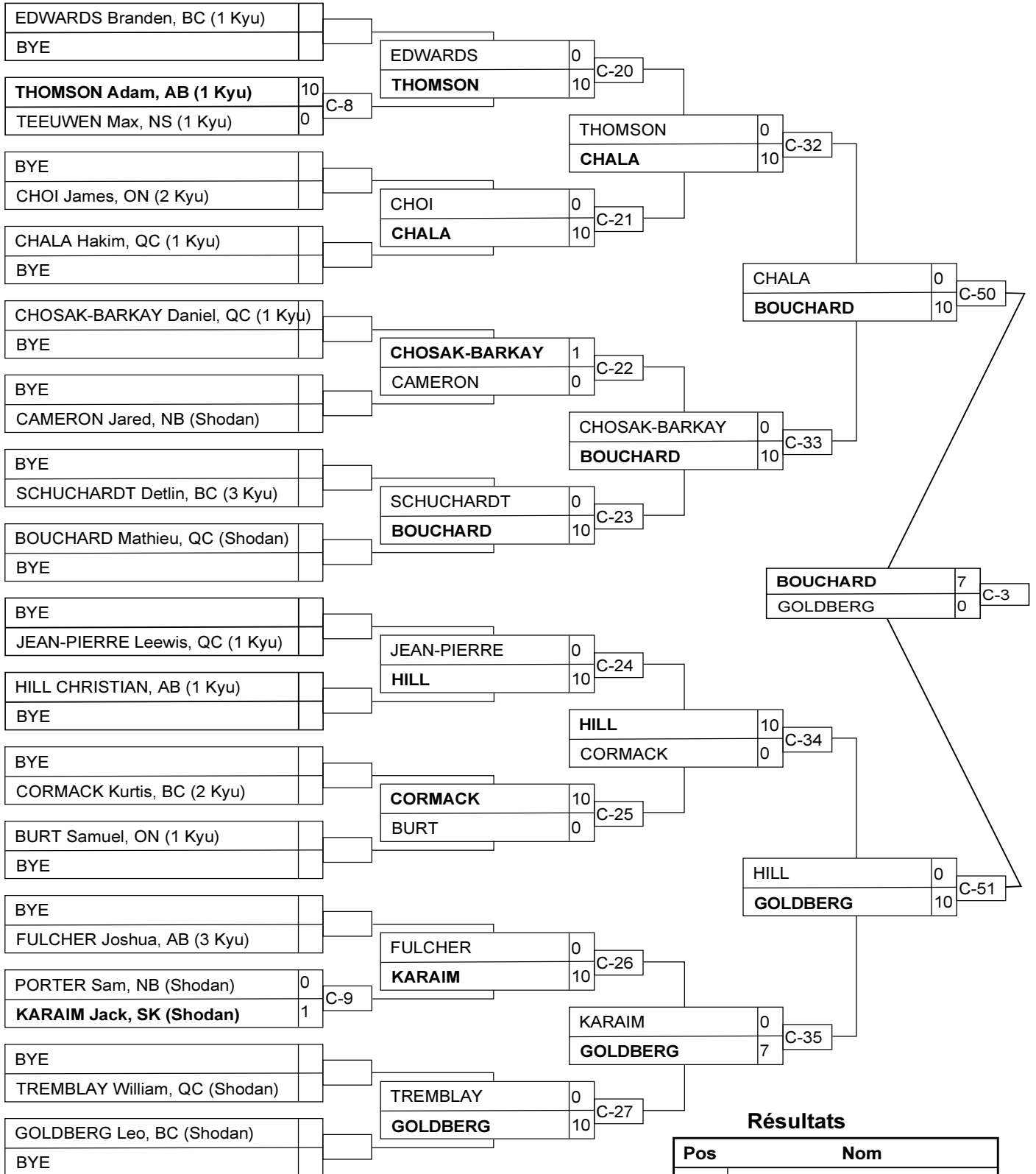

Résultats

Pos	Nom
1	BOUCHARD Mathieu, QC (Shodan)
2	GOLDBERG Leo, BC (Shodan)
3	KARAIM Jack, SK (Shodan)
3	THOMSON Adam, AB (1 Kyu)

U18 M66

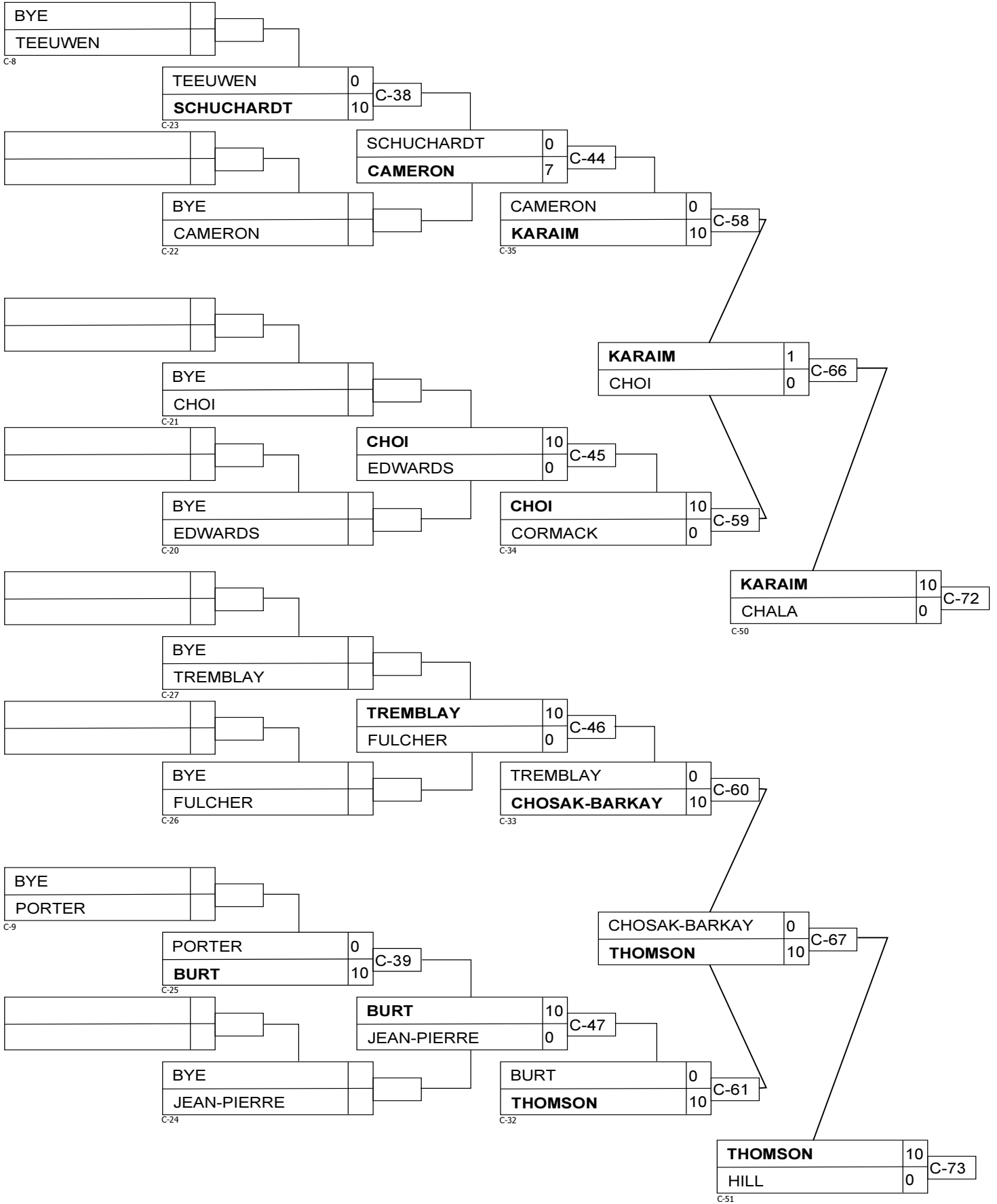

U18 M73

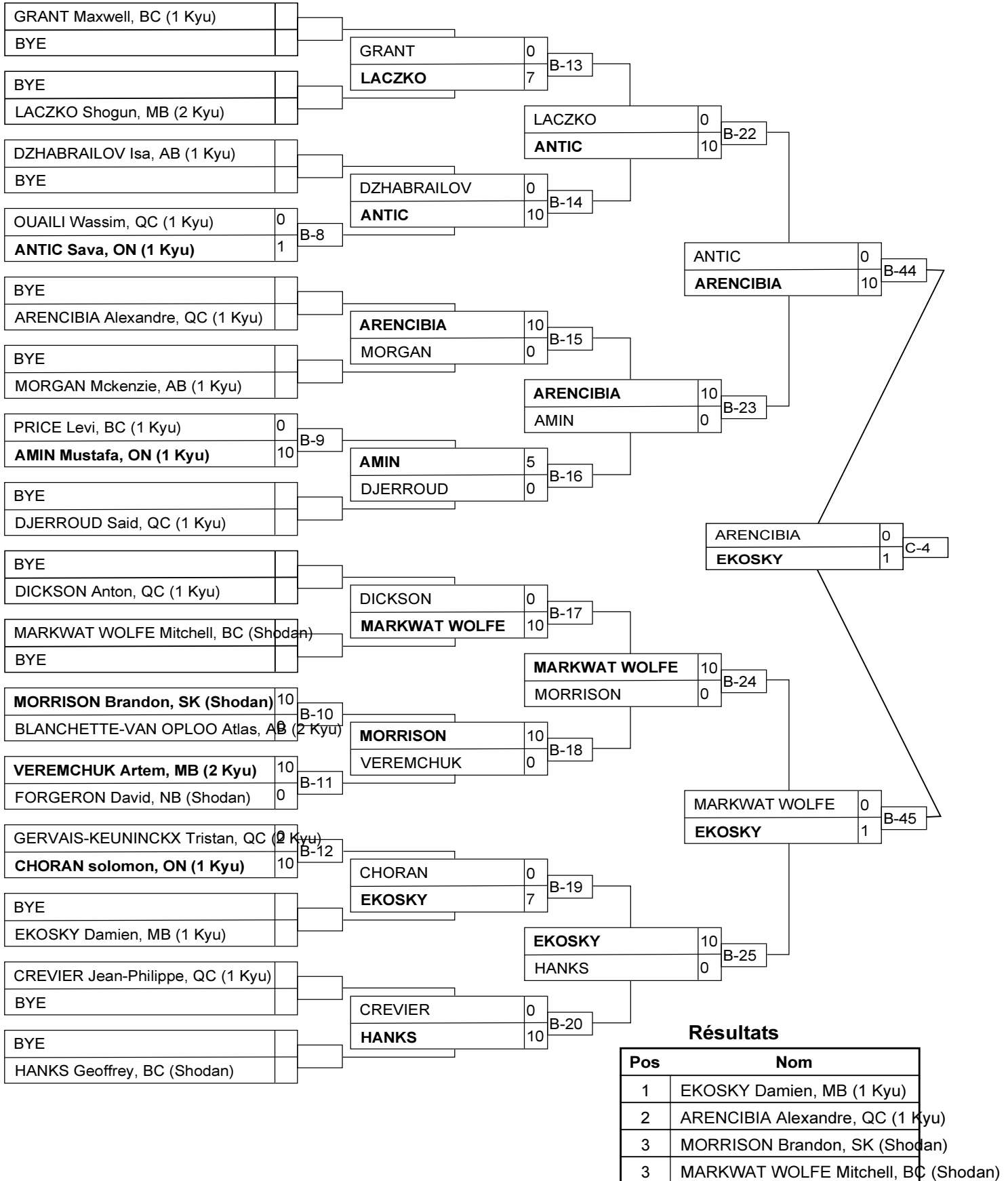

U18 M73

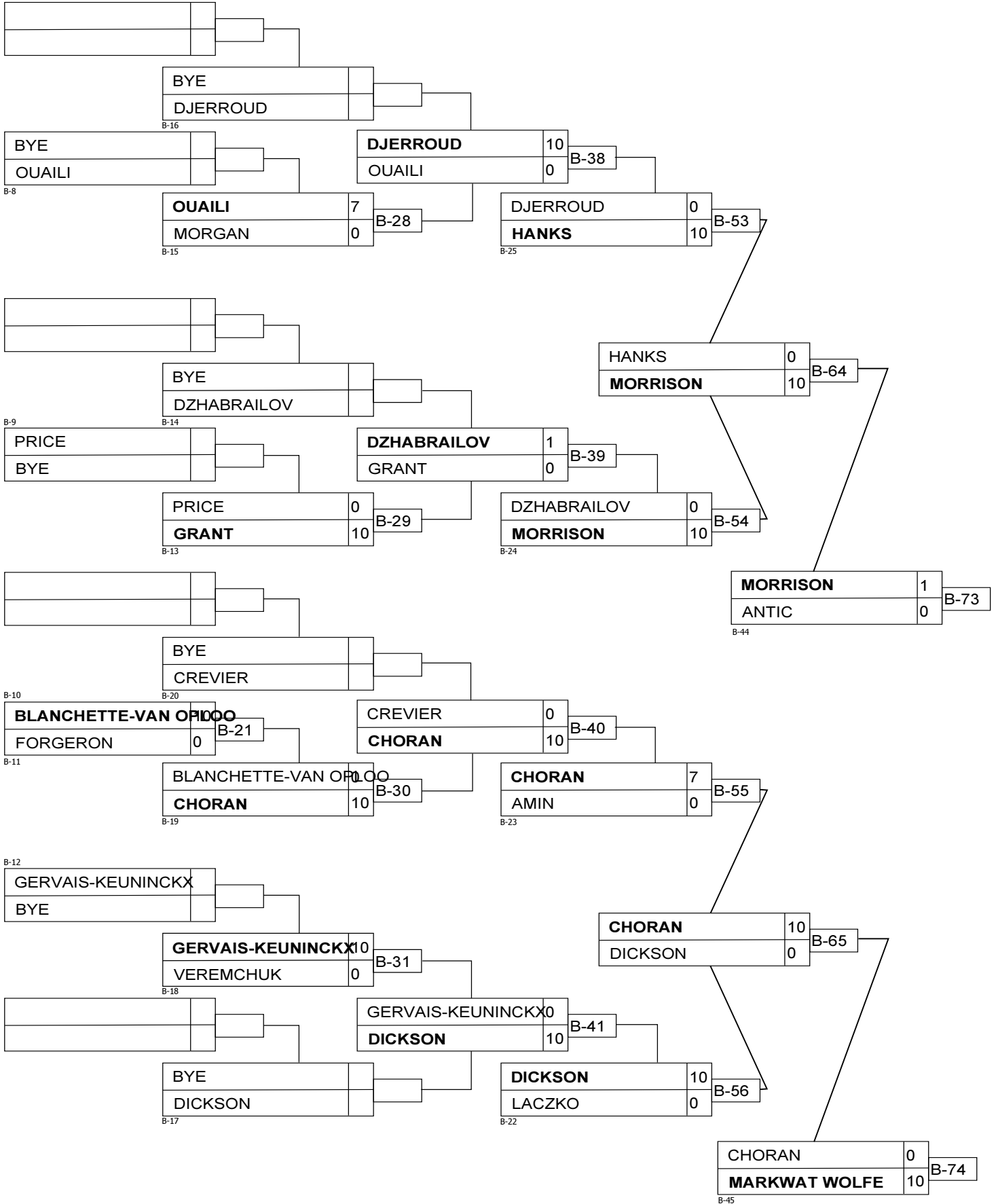

U18 M81

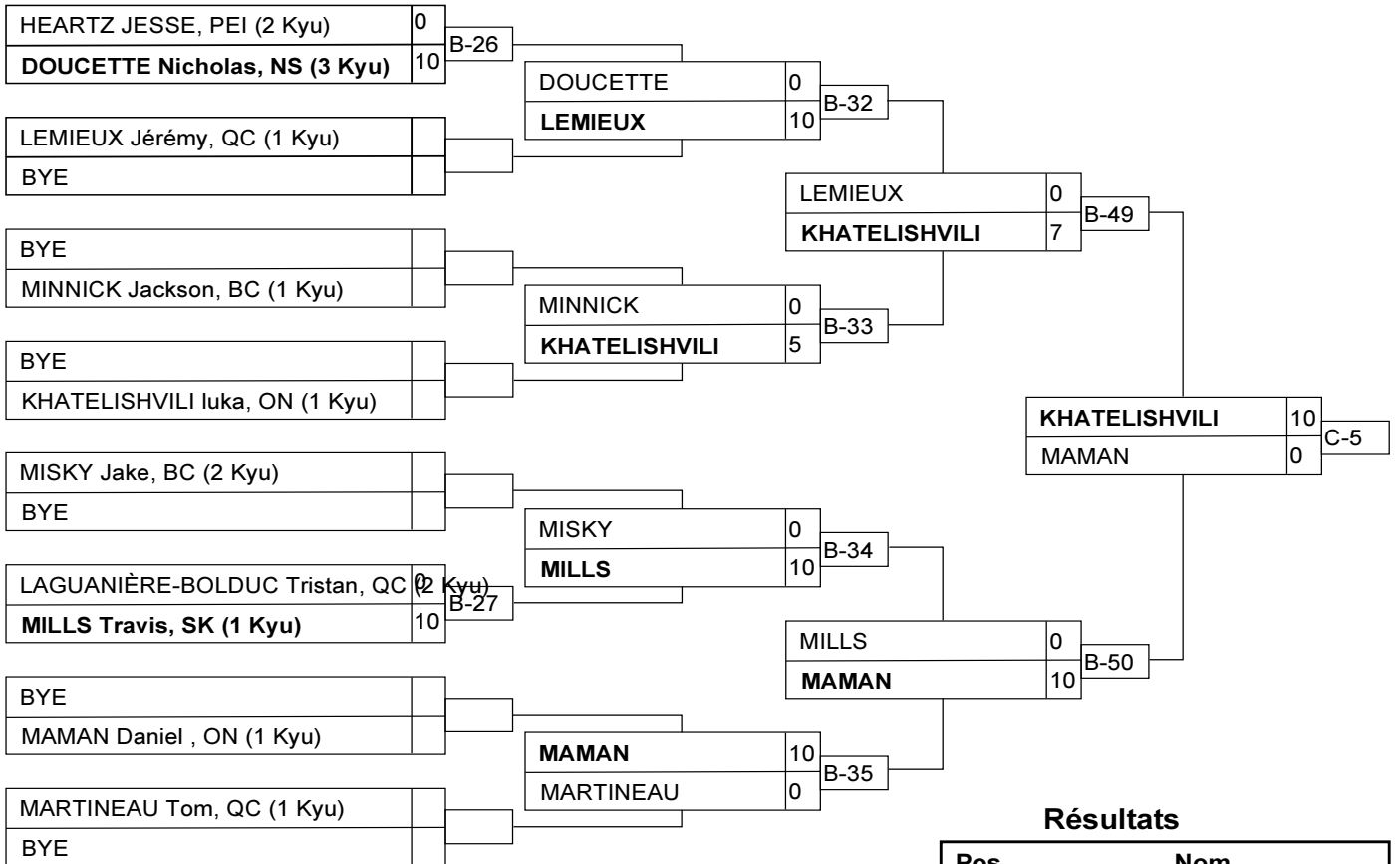

Résultats

Pos	Nom
1	KHATELISHVILI luka, ON (1 Kyu)
2	MAMAN Daniel, ON (1 Kyu)
3	LEMIEUX Jérémy, QC (1 Kyu)
3	MINNICK Jackson, BC (1 Kyu)

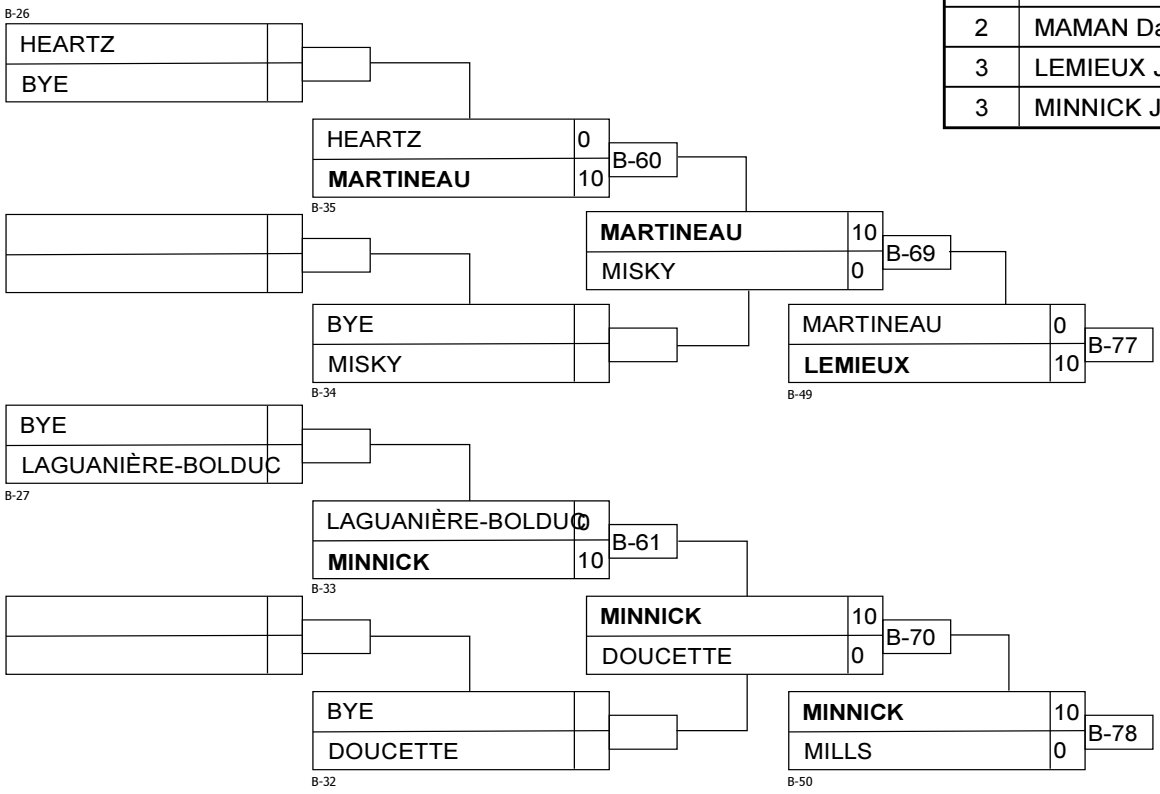

U18 M90

Compétiteurs A

#	Nom	Grade	Club	1	2	3	Vic.	Pts	Pos
1	HENNEBURY Alex	3 Kyu	NS	XX			0	0	3
2	TRAN Thomas	1 Kyu	QC	10	XX	5	2	15	1
3	GALLARDO-PAQUETTE Fabian	1 Kyu	ON	10		XX	1	10	2

Matches A

Match	Blanc			Bleu	Résultat	Temp	Code
C-52	HENNEBURY Alex	1	2	TRAN Thomas	0 - 10	2:48	WIP
C-62	HENNEBURY Alex	1	3	GALLARDO-PAQUETTE Fabian	0 - 10	0:45	IPO
C-68	TRAN Thomas	2	3	GALLARDO-PAQUETTE Fabian	5 - 0	4:00	YUK

Compétiteurs B

#	Nom	Grade	Club	4	5	6	Vic.	Pts	Pos
4	MAZOUZI Idir	1 Kyu	QC	XX	10	10	2	20	1
5	SAULNIER kyle	1 Kyu	ON		XX		0	0	3
6	RYDER Ian	1 Kyu	BC		10	XX	1	10	2

Matches B

Match	Blanc			Bleu	Résultat	Temp	Code
C-53	MAZOUZI Idir	4	5	SAULNIER kyle	10 - 0	1:02	IPO
C-63	MAZOUZI Idir	4	6	RYDER Ian	10 - 0	3:02	IPO
C-69	SAULNIER kyle	5	6	RYDER Ian	0 - 10	1:07	IPO

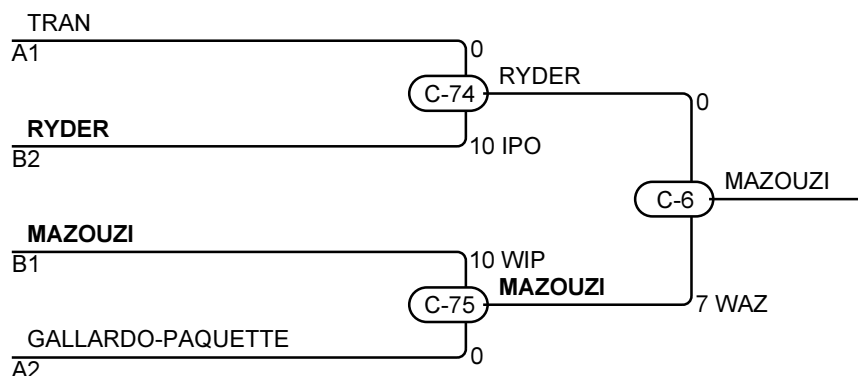

Résultats

Pos	Nom
1	MAZOUZI Idir, QC
2	RYDER Ian , BC
3	TRAN Thomas, QC
3	GALLARDO-PAQUETTE Fabian, ON

U18 M90+

Compétiteurs A

#	Nom	Grade	Club	1	2	3	Vic.	Pts	Pos
1	COUTU XAVIER	1 Kyu	QC	XX	7		1	7	2
2	KUCH Joey	1 Kyu	MB		XX		0	0	3
3	VIENNEAU Andrew	Shodan	NB	10	10	XX	2	20	1

Matches A

Match	Blanc	Bleu	Résultat	Temp	Code
B-46	COUTU XAVIER	1 2 KUCH Joey	7 - 0	4:00	WAZ
B-57	COUTU XAVIER	1 3 VIENNEAU Andrew	0 - 10	0:44	IPO
B-66	KUCH Joey	2 3 VIENNEAU Andrew	0 - 10	1:05	IPO

Compétiteurs B

#	Nom	Grade	Club	4	5	6	Vic.	Pts	Pos
4	CARRILLOS Alexander	1 Kyu	ON	XX	10		1	10	2
5	IWAASA toru	2 Kyu	SK		XX		0	0	3
6	CHOUINARD Yohan	1 Kyu	QC	10	10	XX	2	20	1

Matches B

Match	Blanc	Bleu	Résultat	Temp	Code
B-47	CARRILLOS Alexander	4 5 IWAASA toru	10 - 0	1:05	IPO
B-58	CARRILLOS Alexander	4 6 CHOUINARD Yohan	0 - 10	1:35	IPO
B-67	IWAASA toru	5 6 CHOUINARD Yohan	0 - 10	0:49	WIP

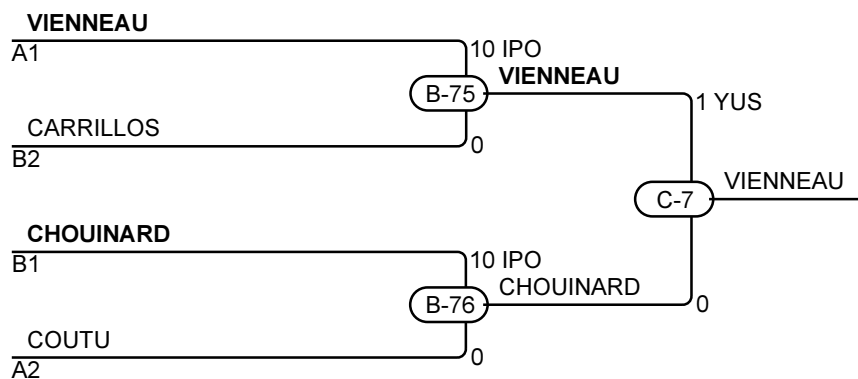

Résultats

Pos	Nom
1	VIENNEAU Andrew, NB
2	CHOUINARD Yohan, QC
3	CARRILLOS Alexander, ON
3	COUTU XAVIER, QC

Veteran 40 to 50 heavy

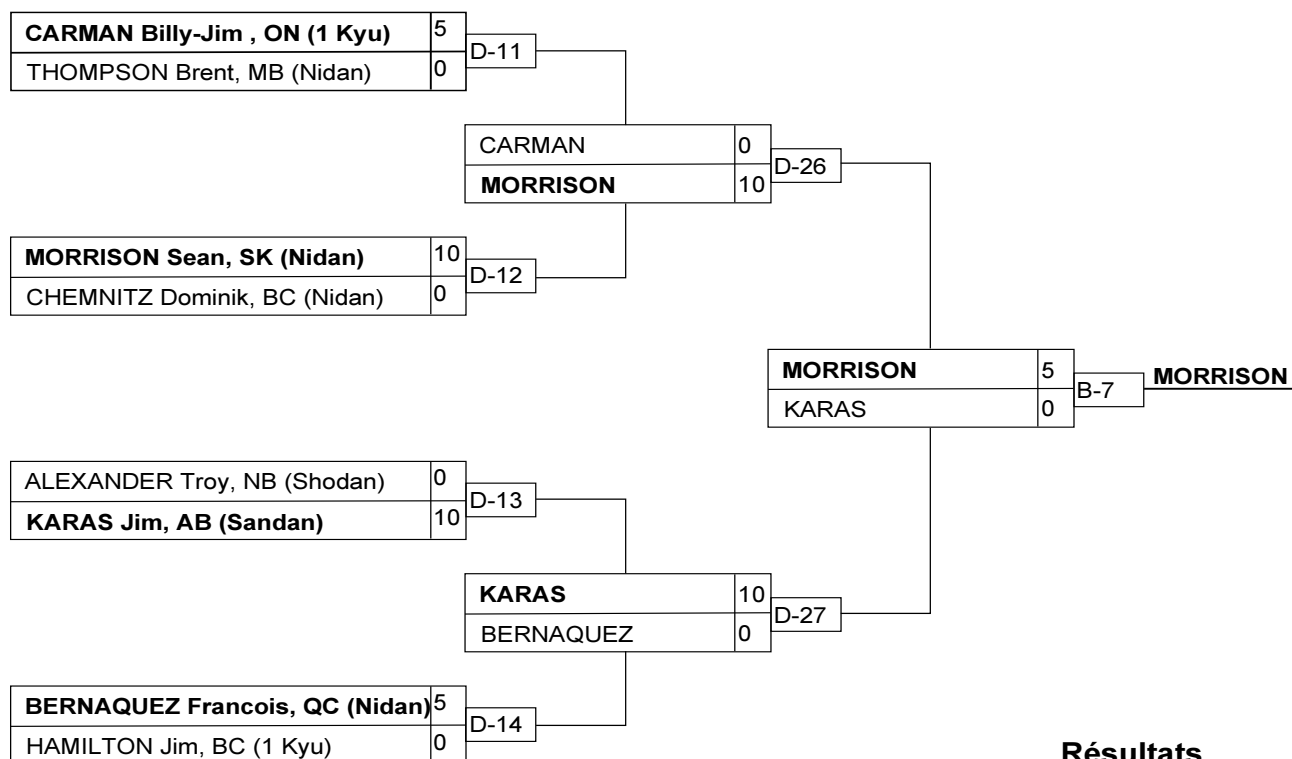

Résultats

Pos	Nom
1	MORRISON Sean, SK (Nidan)
2	KARAS Jim, AB (Sandan)
3	ALEXANDER Troy, NB (Shodan)
3	THOMPSON Brent, MB (Nidan)

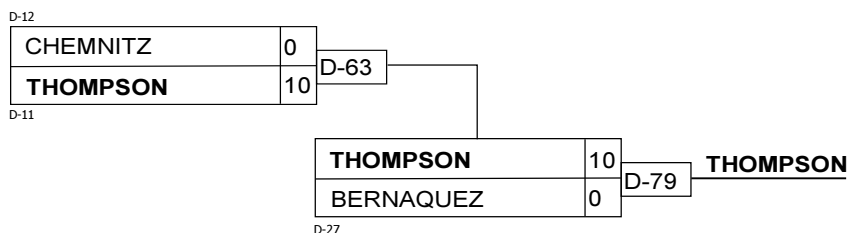
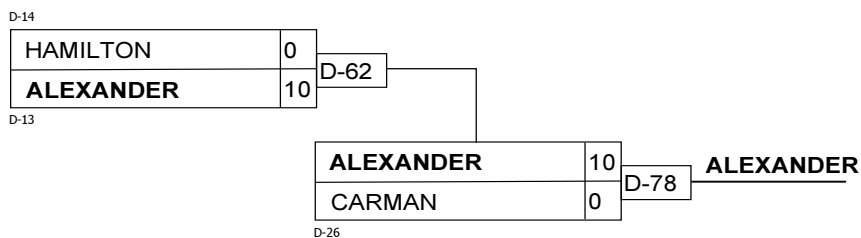

Veteran 40 to 50 light

Compétiteurs

#	Nom	Grade	Club	1	2	3	4	Vic.	Pts	Pos
1	FARGUSON Bryon	Shodan	AB	XX			10	1	10	3
2	TAKAHASHI TIM	Nidan	AB	10	XX	1	10	3	21	1
3	BAN Kevin	1 Kyu	ON	10		XX	7	2	17	2
4	REDFORD Cliff	Shodan	ON				XX	0	0	4

Matches

Match	Blanc			Bleu	Résultat	Temp	Code
D-33	FARGUSON Bryon	1	2	TAKAHASHI TIM	0 - 10	1:29	WIP
D-34	BAN Kevin	3	4	REDFORD Cliff	7 - 0	3:00	WAZ
D-52	FARGUSON Bryon	1	3	BAN Kevin	0 - 10	2:51	WIP
D-53	TAKAHASHI TIM	2	4	REDFORD Cliff	10 - 0	0:23	IPO
D-69	FARGUSON Bryon	1	4	REDFORD Cliff	10 - 0	1:13	IPO
D-70	TAKAHASHI TIM	2	3	BAN Kevin	1 - 0	3:00	YUS

Résultats

Pos	Nom
1	TAKAHASHI TIM, AB
2	BAN Kevin, ON
3	FARGUSON Bryon, AB
4	REDFORD Cliff, ON

Veteran 40 to 50 medium

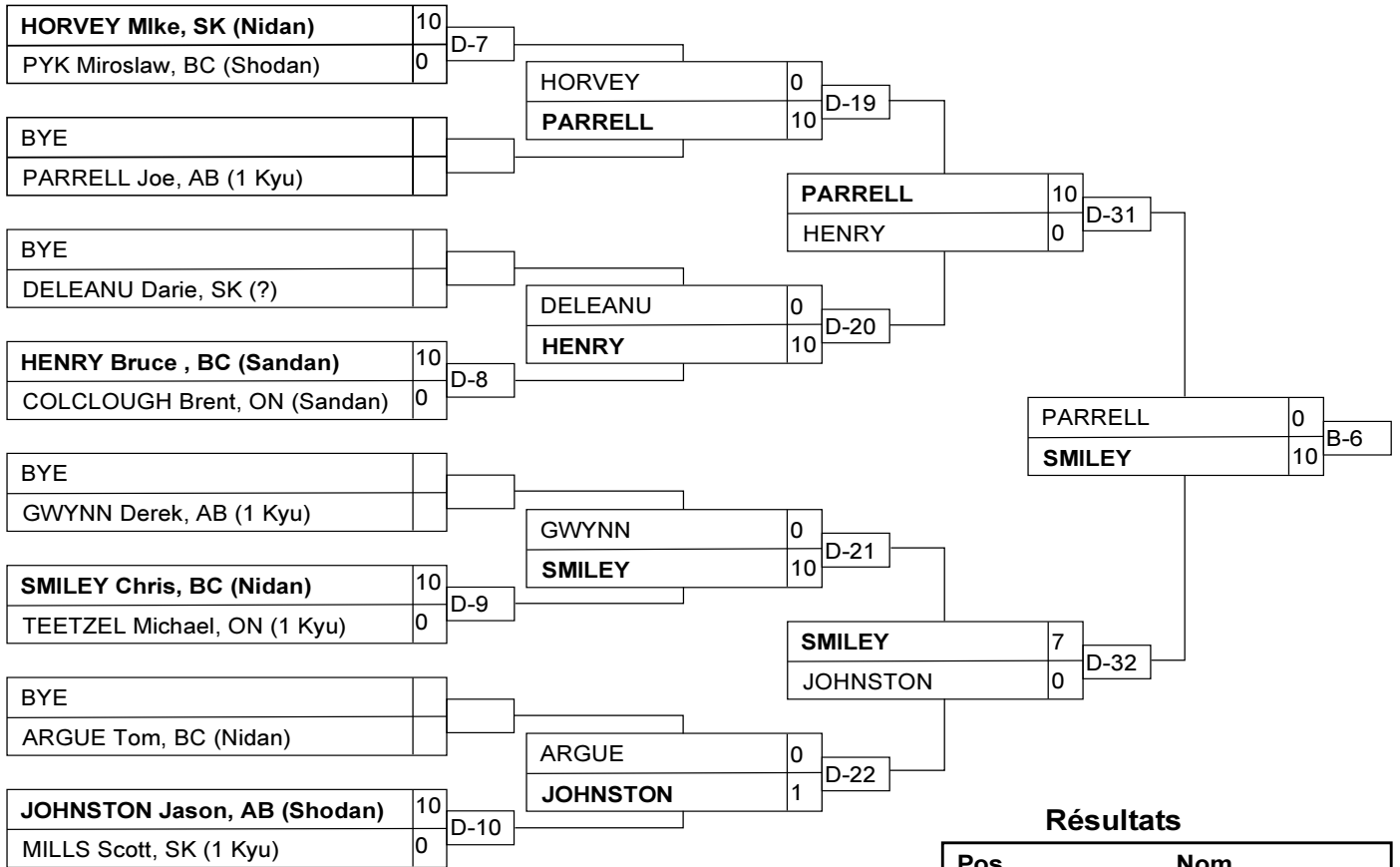

Résultats

Pos	Nom
1	SMILEY Chris, BC (Nidan)
2	PARRELL Joe, AB (1 Kyu)
3	HENRY Bruce, BC (Sandan)
3	HORVEY Mike, SK (Nidan)

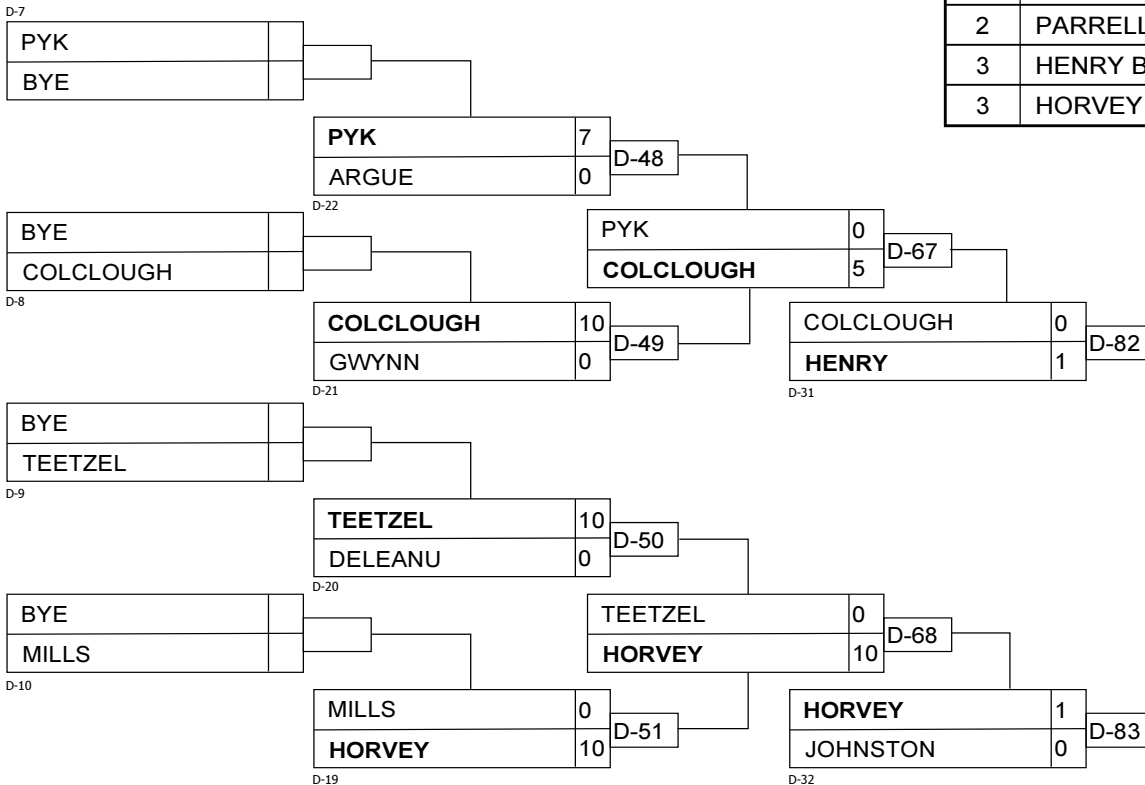

Veteran Over 50 Heavy

Compétiteurs

#	Nom	Grade	Club	1	2	3	4	Vic.	Pts	Pos
1	BIRD Daniel	?	ON	XX				0	0	4
2	MORGENROTH Michael	Nidan	ON	10	XX	10	1	3	21	1
3	SYDNAM Bruce	Sandan	BC	10		XX		1	10	3
4	CAGGIANO Rinaldo	Yondan	NB	10		1	XX	2	11	2

Matches

Match	Blanc			Bleu	Résultat	Temp	Code
D-35	BIRD Daniel	1	2	MORGENROTH Michael	0 - 10	0:14	IPO
D-36	SYDNAM Bruce	3	4	CAGGIANO Rinaldo	0 - 1	3:00	YUS
D-54	BIRD Daniel	1	3	SYDNAM Bruce	0 - 10	0:49	IPO
D-55	MORGENROTH Michael	2	4	CAGGIANO Rinaldo	1 - 0	3:00	YUS
D-71	BIRD Daniel	1	4	CAGGIANO Rinaldo	0 - 10	0:12	IPO
D-72	MORGENROTH Michael	2	3	SYDNAM Bruce	10 - 0	0:30	WIP

Résultats

Pos	Nom
1	MORGENROTH Michael, ON
2	CAGGIANO Rinaldo, NB
3	SYDNAM Bruce, BC
4	BIRD Daniel, ON

Veteran Over 50 light

Compétiteurs

#	Nom	Grade	Club	1	2	1	2	1	2	Vic.	Pts	Pos
1	URITSKY Mikhail	Nidan	AB	XX		XX		XX		0	0	2
2	DIMARCO Jeff	Yondan	BC	10	XX	10	XX		XX	2	20	1

Matches

Match	Blanc			Bleu	Résultat	Temp	Code
D-41	URITSKY Mikhail	1	2	DIMARCO Jeff	0 - 10	0:57	WIP
D-60	URITSKY Mikhail	1	2	DIMARCO Jeff	0 - 10	2:15	IPO
D-77	URITSKY Mikhail	1	2	DIMARCO Jeff			

Résultats

Pos	Nom
1	DIMARCO Jeff, BC
2	URITSKY Mikhail, AB

Veteran Over 50 medium

Compétiteurs

#	Nom	Grade	Club	1	2	1	2	1	2	Vic.	Pts	Pos
1	AGHAEI Fardin	Godan	BC	XX		XX		XX		0	0	2
2	TARGOSINSKI Artur	Nidan	ON	10	XX	5	XX		XX	2	15	1

Matches

Match	Blanc			Bleu	Résultat	Temp	Code
D-25	AGHAEI Fardin	1	2	TARGOSINSKI Artur	0 - 10	2:39	IPO
D-42	AGHAEI Fardin	1	2	TARGOSINSKI Artur	0 - 5	3:00	YUK
D-61	AGHAEI Fardin	1	2	TARGOSINSKI Artur			

Résultats

Pos	Nom
1	TARGOSINSKI Artur, ON
2	AGHAEI Fardin, BC

Veteran Under 40 heavy

Compétiteurs

#	Nom	Grade	Club	1	2	3	Vic.	Pts	Pos
1	ALLEN jeff	1 Kyu	ON	XX		10	1	10	2
2	MCMANUS James	Nidan	NB	10	XX	10	2	20	1
3	KUNZLI COLIN	Shodan	AB			XX	0	0	3

Matches

Match	Blanc			Bleu	Résultat	Temp	Code
D-30	ALLEN jeff	1	2	MCMANUS James	0 - 10	2:30	WIP
D-47	ALLEN jeff	1	3	KUNZLI COLIN	10 - 0	1:20	WIP
D-66	MCMANUS James	2	3	KUNZLI COLIN	10 - 0	1:23	IPO

Résultats

Pos	Nom
1	MCMANUS James, NB
2	ALLEN jeff, ON
3	KUNZLI COLIN, AB

Veteran Under 40 light

Compétiteurs

#	Nom	Grade		Club	1	2	3	Vic.	Pts	Pos
1	KRATKY LLOYD	Shodan	AB		XX			0	0	3
2	MOAZENI Amin	Shodan	AB		10	XX		1	10	2
3	CHIN Rashad	Sandan	AB		5	10	XX	2	15	1

Matches

Match	Blanc		Bleu		Résultat	Temp	Code
D-37	KRATKY LLOYD	1	2	MOAZENI Amin	0 - 10	3:00	IPO
D-56	KRATKY LLOYD	1	3	CHIN Rashad	0 - 5	3:00	YUK
D-73	MOAZENI Amin	2	3	CHIN Rashad	0 - 10	0:48	HAN

Résultats

Pos	Nom
1	CHIN Rashad, AB
2	MOAZENI Amin, AB
3	KRATKY LLOYD, AB

Veteran Under 40 medium

Compétiteurs A

#	Nom	Grade	Club	1	2	3	4	Vic.	Pts	Pos
1	LEMAY Mathieu	Shodan	ON	XX	10	7	10	3	27	1
2	KHILOV Alexandr	Shodan	ON		XX		10	1	10	3
3	MARUYAMA Riley	Nidan	BC		10	XX	10	2	20	2
4	PARKER Gavin	Shodan	AB				XX	0	0	4

Matches A

Match	Blanc	Bleu	Résultat	Temp	Code
D-38	LEMAY Mathieu 1 2	KHILOV Alexandr	10 - 0	1:24	IPO
D-39	MARUYAMA Riley 3 4	PARKER Gavin	10 - 0	0:26	IPO
D-57	LEMAY Mathieu 1 3	MARUYAMA Riley	7 - 0	3:00	WAZ
D-58	KHILOV Alexandr 2 4	PARKER Gavin	10 - 0	0:13	WIP
D-74	LEMAY Mathieu 1 4	PARKER Gavin	10 - 0	2:40	HAN
D-75	KHILOV Alexandr 2 3	MARUYAMA Riley	0 - 10	1:59	IPO

Compétiteurs B

#	Nom	Grade	Club	5	6	7	Vic.	Pts	Pos
5	GUY Eric	Shodan	ON	XX			0	0	3
6	CROWELL KYLE	1 Kyu	AB	10	XX	10	2	20	1
7	KRISTOFFERSEN Samuel	Nidan	NB	7		XX	1	7	2

Matches B

Match	Blanc	Bleu	Résultat	Temp	Code
D-40	GUY Eric 5 6	CROWELL KYLE	0 - 10	1:25	IPO
D-59	GUY Eric 5 7	KRISTOFFERSEN Samuel	0 - 7	3:00	WAZ
D-76	CROWELL KYLE 6 7	KRISTOFFERSEN Samuel	10 - 0	0:21	IPO

LEMAY

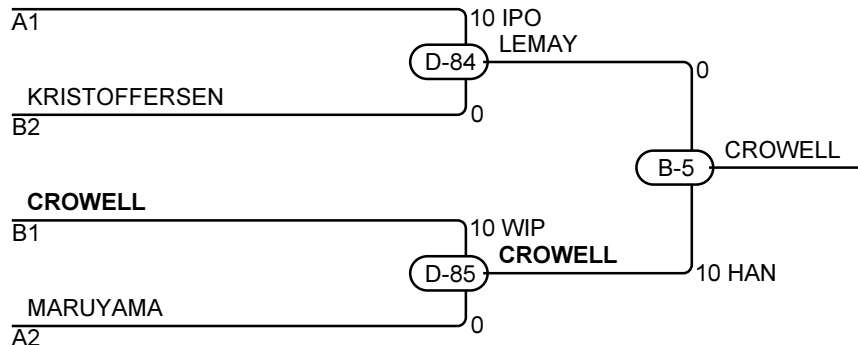

Résultats

Pos	Nom
1	CROWELL KYLE, AB
2	LEMAY Mathieu, ON
3	KRISTOFFERSEN Samuel, NB
3	MARUYAMA Riley, BC