

# U12F pool 1

## Compétiteurs/Competitors

#	Nom/Name	Grade	Club	1	2	3	4	G/W	Pts	Pos
1	CHARNEAU Marielle	5k+	St-Paul l'Ermite	XX	1	1		2	2	2
2	ROY Maya	4k+	Asbestos		XX			0	0	4
3	GRENIER melody	4k	Asbestos		10	XX		1	10	3
4	MALOUM Sylia	4k	Métropolitain	5	10	10	XX	3	25	1

## Matches/Matches

Match	Blanc/White			Bleu/Blue	Rés/Res	Tmp/Tim	Code
A-1	<b>CHARNEAU Marielle</b>	1	2	ROY Maya	1 - 0	0:01	YUS
A-2	GRENIER melody	3	4	<b>MALOUM Sylia</b>	0 - 10	1:03	IPO
A-7	<b>CHARNEAU Marielle</b>	1	3	GRENIER melody	1 - 0	2:00	YUS
A-8	ROY Maya	2	4	<b>MALOUM Sylia</b>	0 - 10	1:47	IPO
A-13	CHARNEAU Marielle	1	4	<b>MALOUM Sylia</b>	0 - 5	2:00	WAZ
A-14	ROY Maya	2	3	<b>GRENIER melody</b>	0 - 10	0:53	IPO

## Résultats/Results

Pos	Nom/Name
1	MALOUM Sylia, Métropolitain
2	CHARNEAU Marielle, St-Paul l'Ermite
3	GRENIER melody, Asbestos

# U12F pool 2

## Compétiteurs/Competitors

#	Nom/Name	Grade	Club	1	2	3	4	G/W	Pts	Pos
1	BEAULIEU Mila	4k+	Beauport	XX	10	10	10	3	30	1
2	TROTIER Lilianne	4k	Baie-Comeau		XX		10	1	10	3
3	TURCOTTE Magalie	5k	Amqui		5	XX	10	2	15	2
4	BARIL Abigail	5k+	Ghishintaïdo				XX	0	0	4

## Matches/Matches

Match	Blanc/White			Bleu/Blue	Rés/Res	Tmp/Tim	Code
A-3	BEAULIEU Mila	1	2	TROTIER Lilianne	10 - 0	0:24	WIP
A-4	TURCOTTE Magalie	3	4	BARIL Abigail	10 - 0	1:44	WIP
A-9	BEAULIEU Mila	1	3	TURCOTTE Magalie	10 - 0	0:21	WIP
A-10	TROTIER Lilianne	2	4	BARIL Abigail	10 - 0	1:33	IPO
A-15	BEAULIEU Mila	1	4	BARIL Abigail	10 - 0	0:18	WIP
A-16	TROTIER Lilianne	2	3	TURCOTTE Magalie	0 - 5	2:00	WAZ

## Résultats/Results

Pos	Nom/Name
1	BEAULIEU Mila, Beauport
2	TURCOTTE Magalie, Amqui
3	TROTIER Lilianne, Baie-Comeau

# U12F pool 3

## Compétiteurs/Competitors

#	Nom/Name	Grade	Club	1	2	3	4	G/W	Pts	Pos
1	GIROUX Daphnée	5k+	Shawinigan	XX				0	0	4
2	MATTON Marilou	4k+	Rikidokan	10	XX		10	2	20	2
3	WARD Florence	2k	Sept-îles	10	10	XX		2	20	1
4	PERRON Maïka	4k	Zenshin	10		1	XX	2	11	3

## Matches/Matches

Match	Blanc/White			Bleu/Blue	Rés/Res	Tmp/Tim	Code
B-1	GIROUX Daphnée	1	2	MATTON Marilou	0 - 10	0:08	IPO
B-2	WARD Florence	3	4	PERRON Maïka	0 - 1	0:01	YUS
B-7	GIROUX Daphnée	1	3	WARD Florence	0 - 10	0:17	WIP
B-8	MATTON Marilou	2	4	PERRON Maïka	10 - 0	1:30	IPO
B-13	GIROUX Daphnée	1	4	PERRON Maïka	0 - 10	0:21	WIP
B-14	MATTON Marilou	2	3	WARD Florence	0 - 10	0:12	IPO

## Résultats/Results

Pos	Nom/Name
1	WARD Florence, Sept-îles
2	MATTON Marilou, Rikidokan
3	PERRON Maïka, Zenshin

# U12F pool 4

## Compétiteurs/Competitors

#	Nom/Name	Grade	Club	1	2	3	4	G/W	Pts	Pos
1	BEAUDIN Marie-Laurence	2k	Sept-îles	XX				0	0	4
2	GARAND Noémie	4k	Zenshin	5	XX		5	2	10	3
3	BÉLANGER Liana	5k+	Hontaï Dojo	10	10	XX		2	20	2
4	BLOUIN Éléonore	4k	CJVR	10		10	XX	2	20	1

## Matches/Matches

Match	Blanc/White			Bleu/Blue	Rés/Res	Tmp/Tim	Code
B-3	BEAUDIN Marie-Laurence	1	2	GARAND Noémie	0 - 5	2:00	WAZ
B-4	BÉLANGER Liana	3	4	BLOUIN Éléonore	0 - 10	0:50	WIP
B-9	BEAUDIN Marie-Laurence	1	3	BÉLANGER Liana	0 - 10	1:29	WIP
B-10	<b>GARAND Noémie</b>	2	4	BLOUIN Éléonore	5 - 0	2:00	WAZ
B-15	BEAUDIN Marie-Laurence	1	4	BLOUIN Éléonore	0 - 10	0:11	IPO
B-16	GARAND Noémie	2	3	BÉLANGER Liana	0 - 10	1:30	WIP

## Résultats/Results

Pos	Nom/Name
1	BLOUIN Éléonore, CJVR
2	BÉLANGER Liana, Hontaï Dojo
3	GARAND Noémie, Zenshin

# U12F pool 5

## Compétiteurs/Competitors

#	Nom/Name	Grade	Club	1	2	3	4	G/W	Pts	Pos
1	MICHAUD Leah	4k+	St-Georges	XX	10			1	10	3
2	BOSSE Florence	4k	Rikidokan		XX			0	0	4
3	LEWIS Kaylee	5k	Perrot Shima	10	10	XX		2	20	2
4	BEAUDIN Sara-Anne	2k	Sept-îles	10	10	10	XX	3	30	1

## Matches/Matches

Match	Blanc/White			Bleu/Blue	Rés/Res	Tmp/Tim	Code
C-1	MICHAUD Leah	1	2	BOSSE Florence	10 - 0	0:25	WIP
C-2	LEWIS Kaylee	3	4	BEAUDIN Sara-Anne	0 - 10	0:38	IPO
C-7	MICHAUD Leah	1	3	LEWIS Kaylee	0 - 10	0:07	IPO
C-8	BOSSE Florence	2	4	BEAUDIN Sara-Anne	0 - 10	0:17	WIP
C-13	MICHAUD Leah	1	4	BEAUDIN Sara-Anne	0 - 10	0:33	IPO
C-14	BOSSE Florence	2	3	LEWIS Kaylee	0 - 10	0:26	IPO

## Résultats/Results

Pos	Nom/Name
1	BEAUDIN Sara-Anne, Sept-îles
2	LEWIS Kaylee, Perrot Shima
3	MICHAUD Leah, St-Georges

# U12F pool 6

## Compétiteurs/Competitors

#	Nom/Name	Grade	Club	1	2	3	4	G/W	Pts	Pos
1	THIBEAULT Hayden	4k+	Baie-Comeau	XX	10	10	10	3	30	1
2	THIBAULT Charlie	4k+	Seikidokan		XX		10	1	10	3
3	COURTOIS Justine	4k	Kime-Waza		10	XX	10	2	20	2
4	PROULX--OLSON Dakota	4k+	Perrot Shima				XX	0	0	4

## Matches/Matches

Match	Blanc/White			Bleu/Blue	Rés/Res	Tmp/Tim	Code
C-3	THIBEAULT Hayden	1	2	THIBAULT Charlie	10 - 0	0:01	IPO
C-4	COURTOIS Justine	3	4	PROULX--OLSON Dakota	10 - 0	0:18	WIP
C-9	THIBEAULT Hayden	1	3	COURTOIS Justine	10 - 0	0:49	WIP
C-10	THIBAULT Charlie	2	4	PROULX--OLSON Dakota	10 - 0	1:03	IPO
C-15	THIBEAULT Hayden	1	4	PROULX--OLSON Dakota	10 - 0	0:20	IPO
C-16	THIBAULT Charlie	2	3	COURTOIS Justine	0 - 10	0:31	IPO

## Résultats/Results

Pos	Nom/Name
1	THIBEAULT Hayden, Baie-Comeau
2	COURTOIS Justine, Kime-Waza
3	THIBAULT Charlie, Seikidokan

# U12F pool 7

## Compétiteurs/Competitors

#	Nom/Name	Grade	Club	1	2	3	4	G/W	Pts	Pos
1	COTTE Alexandrine	4k+	Sept-îles	XX	10	10		2	20	2
2	ROBERT Alycia	4k	Seikidokan		XX	10		1	10	3
3	VALOIS FORTIER Alice	4k+	Beauport			XX		0	0	4
4	GAUTHIÉ Emma	4k	Seiko	10	10	10	XX	3	30	1

## Matches/Matches

Match	Blanc/White			Bleu/Blue	Rés/Res	Tmp/Tim	Code
D-1	<b>COTTE Alexandrine</b>	1	2	ROBERT Alycia	10 - 0	0:06	IPO
D-2	VALOIS FORTIER Alice	3	4	<b>GAUTHIÉ Emma</b>	0 - 10	0:20	WIP
D-7	<b>COTTE Alexandrine</b>	1	3	VALOIS FORTIER Alice	10 - 0	0:17	WIP
D-8	ROBERT Alycia	2	4	<b>GAUTHIÉ Emma</b>	0 - 10	0:39	IPO
D-13	COTTE Alexandrine	1	4	<b>GAUTHIÉ Emma</b>	0 - 10	0:36	WIP
D-14	<b>ROBERT Alycia</b>	2	3	VALOIS FORTIER Alice	10 - 0	1:30	IPO

## Résultats/Results

Pos	Nom/Name
1	GAUTHIÉ Emma, Seiko
2	COTTE Alexandrine, Sept-îles
3	ROBERT Alycia, Seikidokan

# U12F pool 8

## Compétiteurs/Competitors

#	Nom/Name	Grade	Club	1	2	3	4	G/W	Pts	Pos
1	TURCOTTE Audrey-Ann	2k	Sept-îles	XX	10			1	10	3
2	COUTURIER Ellie	4k+	Judo-Tech		XX			0	0	4
3	PROULX-OLSON Emma	3k	Perrot Shima	10	10	XX	1	3	21	1
4	BOURQUE Charline	4k+	St-Georges	10	10		XX	2	20	2

## Matches/Matches

Match	Blanc/White			Bleu/Blue	Rés/Res	Tmp/Tim	Code
D-3	<b>TURCOTTE Audrey-Ann</b>	1	2	COUTURIER Ellie	10 - 0	0:01	IPO
D-4	<b>PROULX-OLSON Emma</b>	3	4	BOURQUE Charline	1 - 0	2:00	YUS
D-9	TURCOTTE Audrey-Ann	1	3	<b>PROULX-OLSON Emma</b>	0 - 10	0:48	WIP
D-10	COUTURIER Ellie	2	4	<b>BOURQUE Charline</b>	0 - 10	0:34	WIP
D-15	TURCOTTE Audrey-Ann	1	4	<b>BOURQUE Charline</b>	0 - 10	1:05	WIP
D-16	COUTURIER Ellie	2	3	<b>PROULX-OLSON Emma</b>	0 - 10	0:37	WIP

## Résultats/Results

Pos	Nom/Name
1	PROULX-OLSON Emma, Perrot Shima
2	BOURQUE Charline, St-Georges
3	TURCOTTE Audrey-Ann, Sept-îles



# U12F pool 9

## Compétiteurs/Competitors

#	Nom/Name	Grade	Club	1	2	3	4	G/W	Pts	Pos
1	DORVAL-MBELE Missy Jen	5k+	Torii	XX	10	10		2	20	2
2	BENOIT Mathilde	5k+	Rikidokan		XX			0	0	4
3	HAINEAULT Jade	4k	Boucherville		10	XX		1	10	3
4	CARTIER Anabelle	5k+	Zenshin	10	5	10	XX	3	25	1

## Matches/Matches

Match	Blanc/White			Bleu/Blue	Rés/Res	Tmp/Tim	Code
E-1	<b>DORVAL-MBELE Missy Jen</b>	1	2	BENOIT Mathilde	10 - 0	1:04	IPO
E-2	HAINEAULT Jade	3	4	<b>CARTIER Anabelle</b>	0 - 10	0:01	IPO
E-7	<b>DORVAL-MBELE Missy Jen</b>	1	3	HAINEAULT Jade	10 - 0	1:37	WIP
E-8	BENOIT Mathilde	2	4	<b>CARTIER Anabelle</b>	0 - 5	2:00	WAZ
E-13	DORVAL-MBELE Missy Jen	1	4	<b>CARTIER Anabelle</b>	0 - 10	1:35	IPO
E-14	BENOIT Mathilde	2	3	<b>HAINEAULT Jade</b>	0 - 10	0:22	WIP

## Résultats/Results

Pos	Nom/Name
1	CARTIER Anabelle, Zenshin
2	DORVAL-MBELE Missy Jen, Torii
3	HAINEAULT Jade, Boucherville

# U12M pool 1

## Compétiteurs/Competitors

#	Nom/Name	Grade	Club	1	2	3	4	G/W	Pts	Pos
1	GERMAIN Félix	4k+	Seikidokan	XX	10		10	2	20	2
2	ASSELIN-GOBEIL Antoine	5k+	Chicoutimi		XX		10	1	10	3
3	GAUDREAUULT Malick	5k+	Albatros	10	10	XX	10	3	30	1
4	GAUTHIER Félix	4k+	Jonquière				XX	0	0	4

## Matches/Matches

Match	Blanc/White			Bleu/Blue	Rés/Res	Tmp/Tim	Code
A-5	<b>GERMAIN Félix</b>	1	2	ASSELIN-GOBEIL Antoine	10 - 0	0:56	IPO
A-6	<b>GAUDREAUULT Malick</b>	3	4	GAUTHIER Félix	10 - 0	0:51	IPO
A-11	GERMAIN Félix	1	3	<b>GAUDREAUULT Malick</b>	0 - 10	0:06	IPO
A-12	<b>ASSELIN-GOBEIL Antoine</b>	2	4	GAUTHIER Félix	10 - 0	0:36	WIP
A-17	<b>GERMAIN Félix</b>	1	4	GAUTHIER Félix	10 - 0	0:37	WIP
A-18	ASSELIN-GOBEIL Antoine	2	3	<b>GAUDREAUULT Malick</b>	0 - 10	0:10	IPO

## Résultats/Results

Pos	Nom/Name
1	GAUDREAUULT Malick, Albatros
2	GERMAIN Félix, Seikidokan
3	ASSELIN-GOBEIL Antoine, Chicoutimi

# U12M pool 10

## Compétiteurs/Competitors

#	Nom/Name	Grade	Club	1	2	3	4	5	G/W	Pts	Pos
1	LEVESQUE Arthur	4k+	Bushidokan	XX			10		1	10	4
2	RODGERS Julien	4k+	Sept-îles	10	XX		10	10	3	30	2
3	JEANPIERRE Antoine	4k+	Budo Kwai	10	10	XX	10	10	4	40	1
4	MONTGRAIN William	5k	Amqui				XX		0	0	5
5	BRIÈRE Alexandre	4k	Jonquière	10			5	XX	2	15	3

## Matches/Matches

Match	Blanc/White			Bleu/Blue	Rés/Res	Tmp/Tim	Code
B-19	MONTGRAIN William	4	5	BRIÈRE Alexandre	0 - 5	2:00	WAZ
B-20	LEVESQUE Arthur	1	2	RODGERS Julien	0 - 10	1:13	WIP
B-25	<b>JEANPIERRE Antoine</b>	3	4	MONTGRAIN William	10 - 0	0:38	IPO
B-26	LEVESQUE Arthur	1	5	BRIÈRE Alexandre	0 - 10	1:44	WIP
B-31	RODGERS Julien	2	3	JEANPIERRE Antoine	0 - 10	1:11	WIP
B-32	<b>LEVESQUE Arthur</b>	1	4	MONTGRAIN William	10 - 0	0:10	IPO
B-34A	<b>JEANPIERRE Antoine</b>	3	5	BRIÈRE Alexandre	10 - 0	0:09	IPO
B-35A	<b>RODGERS Julien</b>	2	4	MONTGRAIN William	10 - 0	0:36	WIP
B-36B	LEVESQUE Arthur	1	3	JEANPIERRE Antoine	0 - 10	1:14	WIP
B-36B	<b>RODGERS Julien</b>	2	5	BRIÈRE Alexandre	10 - 0	0:58	IPO

## Résultats/Results

Pos	Nom/Name
1	JEANPIERRE Antoine, Budo Kwai
2	RODGERS Julien, Sept-îles
3	BRIÈRE Alexandre, Jonquière
4	LEVESQUE Arthur, Bushidokan

# U12M pool 11

## Compétiteurs/Competitors

#	Nom/Name	Grade	Club	1	2	3	4	G/W	Pts	Pos
1	DUBÉ Elliot	5k	Judo-Tani	XX	10	10	5	3	25	1
2	D'ARTERIO Corey	4k+	Perrot Shima		XX			0	0	4
3	RIVERIN Jacob	4k	Jonquière		10	XX		1	10	3
4	LANGELIER Hugo	2k	Sept-îles		10	5	XX	2	15	2

## Matches/Matches

Match	Blanc/White			Bleu/Blue	Rés/Res	Tmp/Tim	Code
B-21	<b>DUBÉ Elliot</b>	1	2	D'ARTERIO Corey	10 - 0	0:16	WIP
B-22	RIVERIN Jacob	3	4	<b>LANGELIER Hugo</b>	0 - 5	2:00	WAZ
B-27	<b>DUBÉ Elliot</b>	1	3	RIVERIN Jacob	10 - 0	0:38	WIP
B-28	D'ARTERIO Corey	2	4	<b>LANGELIER Hugo</b>	0 - 10	0:24	WIP
B-33	<b>DUBÉ Elliot</b>	1	4	LANGELIER Hugo	5 - 0	2:00	WAZ
B-34	D'ARTERIO Corey	2	3	<b>RIVERIN Jacob</b>	0 - 10	1:00	WIP

## Résultats/Results

Pos	Nom/Name
1	DUBÉ Elliot, Judo-Tani
2	LANGELIER Hugo, Sept-îles
3	RIVERIN Jacob, Jonquière

# U12M pool 12

## Compétiteurs/Competitors

#	Nom/Name	Grade	Club	1	2	3	4	G/W	Pts	Pos
1	PELLETIER Eli	5k+	Judo-Tech	XX	1		1	2	2	2
2	BEAULIEU Vincent	5k+	Judo-Tech		XX			0	0	4
3	CHENNOUFI iliass	4k+	Judo Ben	10	10	XX	10	3	30	1
4	MARTEL Émile	4k	Budo Kwai		10		XX	1	10	3

## Matches/Matches

Match	Blanc/White			Bleu/Blue	Rés/Res	Tmp/Tim	Code
B-23	PELLETIER Eli	1	2	BEAULIEU Vincent	1 - 0	2:00	YUS
B-24	CHENNOUFI iliass	3	4	MARTEL Émile	10 - 0	0:06	IPO
B-29	PELLETIER Eli	1	3	CHENNOUFI iliass	0 - 10	0:17	WIP
B-30	BEAULIEU Vincent	2	4	MARTEL Émile	0 - 10	0:24	WIP
B-35	PELLETIER Eli	1	4	MARTEL Émile	1 - 0	2:00	YUS
B-36	BEAULIEU Vincent	2	3	CHENNOUFI iliass	0 - 10	0:01	FUS

## Résultats/Results

Pos	Nom/Name
1	CHENNOUFI iliass, Judo Ben
2	PELLETIER Eli, Judo-Tech
3	MARTEL Émile, Budo Kwai

# U12M pool 13

## Compétiteurs/Competitors

#	Nom/Name	Grade	Club	1	2	3	4	G/W	Pts	Pos
1	KANE Ousmane	5k+	Olympique	XX	1	10	10	3	21	1
2	ÉMOND Alexis	3k	Jonquière		XX		10	1	10	3
3	CYR Raphael	2k	Sept-îles		10	XX	10	2	20	2
4	DUGUAY Ryan	3k	Port Cartier				XX	0	0	4

## Matches/Matches

Match	Blanc/White			Bleu/Blue	Rés/Res	Tmp/Tim	Code
C-19	KANE Ousmane	1	2	ÉMOND Alexis	1 - 0	2:00	YUS
C-20	CYR Raphael	3	4	DUGUAY Ryan	10 - 0	0:25	IPO
C-25	KANE Ousmane	1	3	CYR Raphael	10 - 0	1:46	IPO
C-26	ÉMOND Alexis	2	4	DUGUAY Ryan	10 - 0	0:53	IPO
C-31	KANE Ousmane	1	4	DUGUAY Ryan	10 - 0	0:44	IPO
C-32	ÉMOND Alexis	2	3	CYR Raphael	0 - 10	1:14	WIP

## Résultats/Results

Pos	Nom/Name
1	KANE Ousmane , Olympique
2	CYR Raphael, Sept-îles
3	ÉMOND Alexis, Jonquière

# U12M pool 14

## Compétiteurs/Competitors

#	Nom/Name	Grade	Club	1	2	3	4	G/W	Pts	Pos
1	BEAULAC Adam	4k+	Seikidokan	XX				0	0	4
2	BEAUPRÉ Edouard	4k	Sept-îles	10	XX	10	10	3	30	1
3	CLAVEAU Jeremie	5k	Baie-Comeau	10		XX		1	10	3
4	ZOUAOUI Gibril Alexander	4k+	Boucherville	10		10	XX	2	20	2

## Matches/Matches

Match	Blanc/White			Bleu/Blue	Rés/Res	Tmp/Tim	Code
C-21	BEAULAC Adam	1	2	BEAUPRÉ Edouard	0 - 10	0:06	IPO
C-22	CLAVEAU Jeremie	3	4	ZOUAOUI Gibril Alexander	0 - 10	0:46	IPO
C-27	BEAULAC Adam	1	3	CLAVEAU Jeremie	0 - 10	0:22	WIP
C-28	BEAUPRÉ Edouard	2	4	ZOUAOUI Gibril Alexander	10 - 0	0:37	IPO
C-33	BEAULAC Adam	1	4	ZOUAOUI Gibril Alexander	0 - 10	2:00	WIP
C-34	BEAUPRÉ Edouard	2	3	CLAVEAU Jeremie	10 - 0	0:39	WIP

## Résultats/Results

Pos	Nom/Name
1	BEAUPRÉ Edouard, Sept-îles
2	ZOUAOUI Gibril Alexander, Boucherville
3	CLAVEAU Jeremie, Baie-Comeau

# U12M pool 15

## Compétiteurs/Competitors

#	Nom/Name	Grade	Club	1	2	3	4	G/W	Pts	Pos
1	BRASSARD Alexis	4k	Baie-Comeau	XX				0	0	4
2	BOULAY Tommy	3k	Sept-îles	10	XX	10		2	20	2
3	ARSENAULT Louis-Félix	3k	Judo-Tani	10		XX		1	10	3
4	HADJ-BACHIR amine	3k	Judo Ben	10	10	10	XX	3	30	1

## Matches/Matches

Match	Blanc/White			Bleu/Blue	Rés/Res	Tmp/Tim	Code
C-23	BRASSARD Alexis	1	2	BOULAY Tommy	0 - 10	0:21	IPO
C-24	ARSENAULT Louis-Félix	3	4	HADJ-BACHIR amine	0 - 10	0:16	IPO
C-29	BRASSARD Alexis	1	3	ARSENAULT Louis-Félix	0 - 10	0:54	IPO
C-30	BOULAY Tommy	2	4	HADJ-BACHIR amine	0 - 10	0:05	IPO
C-35	BRASSARD Alexis	1	4	HADJ-BACHIR amine	0 - 10	0:06	IPO
C-36	BOULAY Tommy	2	3	ARSENAULT Louis-Félix	10 - 0	1:04	IPO

## Résultats/Results

Pos	Nom/Name
1	HADJ-BACHIR amine, Judo Ben
2	BOULAY Tommy, Sept-îles
3	ARSENAULT Louis-Félix, Judo-Tani



# U12M pool 16

## Compétiteurs/Competitors

#	Nom/Name	Grade	Club	1	2	3	4	G/W	Pts	Pos
1	CANUEL Félix	4k	Rikidokan	XX				0	0	4
2	DUBÉ Charles	5k+	Judo-La Pocatiere	10	XX	10		2	20	2
3	FONTAINE HANS	3k+	CJVR	10		XX		1	10	3
4	BRIDEAU Arnaud	4k	Judo-Tani	10	10	1	XX	3	21	1

## Matches/Matches

Match	Blanc/White			Bleu/Blue	Rés/Res	Tmp/Tim	Code
D-19	CANUEL Félix	1	2	DUBÉ Charles	0 - 10	0:15	IPO
D-20	FONTAINE HANS	3	4	BRIDEAU Arnaud	0 - 1	2:00	YUS
D-25	CANUEL Félix	1	3	FONTAINE HANS	0 - 10	0:30	IPO
D-26	DUBÉ Charles	2	4	BRIDEAU Arnaud	0 - 10	1:08	WIP
D-31	CANUEL Félix	1	4	BRIDEAU Arnaud	0 - 10	0:09	IPO
D-32	DUBÉ Charles	2	3	FONTAINE HANS	10 - 0	1:33	WIP

## Résultats/Results

Pos	Nom/Name
1	BRIDEAU Arnaud, Judo-Tani
2	DUBÉ Charles, Judo-La Pocatiere
3	FONTAINE HANS, CJVR

# U12M pool 17

## Compétiteurs/Competitors

#	Nom/Name	Grade	Club	1	2	3	4	G/W	Pts	Pos
1	VIEUX PERNON MARTIN	4k+	Boucherville	XX	10	10	10	3	30	1
2	CROTEAU jérémie	4k	Judo Victo		XX	10		1	10	3
3	HACHIYA-COLLETTE jonathan	3k+	Torakai			XX		0	0	4
4	LAOUARI MAYAS	5k+	Judo Ben		10	10	XX	2	20	2

## Matches/Matches

Match	Blanc/White			Bleu/Blue	Rés/Res	Tmp/Tim	Code
D-21	<b>VIEUX PERNON MARTIN</b>	1	2	CROTEAU jérémie	10 - 0	0:10	IPO
D-22	HACHIYA-COLLETTE jonathan	3	4	<b>LAOUARI MAYAS</b>	0 - 10	1:26	WIP
D-27	<b>VIEUX PERNON MARTIN</b>	1	3	HACHIYA-COLLETTE jonathan	10 - 0	1:51	IPO
D-28	CROTEAU jérémie	2	4	<b>LAOUARI MAYAS</b>	0 - 10	0:49	IPO
D-33	<b>VIEUX PERNON MARTIN</b>	1	4	LAOUARI MAYAS	10 - 0	0:44	IPO
D-34	<b>CROTEAU jérémie</b>	2	3	HACHIYA-COLLETTE jonathan	10 - 0	0:56	WIP

## Résultats/Results

Pos	Nom/Name
1	VIEUX PERNON MARTIN, Boucherville
2	LAOUARI MAYAS, Judo Ben
3	CROTEAU jérémie, Judo Victo

# U12M pool 18

## Compétiteurs/Competitors

#	Nom/Name	Grade	Club	1	2	3	4	G/W	Pts	Pos
1	RÉGLAT-ARZATE Mateo	4k+	Lachenaie	XX	10	1		2	11	2
2	LALIBERTÉ Dominik	4k	Longueuil		XX			0	0	4
3	TREMBLAY james	4k	Seiko		10	XX		1	10	3
4	VILLAVERA Darius	4k+	Bushidokan	10	10	10	XX	3	30	1

## Matches/Matches

Match	Blanc/White			Bleu/Blue	Rés/Res	Tmp/Tim	Code
D-23	<b>RÉGLAT-ARZATE Mateo</b>	1	2	LALIBERTÉ Dominik	10 - 0	0:18	WIP
D-24	TREMBLAY james	3	4	<b>VILLAVERA Darius</b>	0 - 10	0:24	IPO
D-29	<b>RÉGLAT-ARZATE Mateo</b>	1	3	TREMBLAY james	1 - 0	2:00	YUS
D-30	LALIBERTÉ Dominik	2	4	<b>VILLAVERA Darius</b>	0 - 10	0:33	WIP
D-35	RÉGLAT-ARZATE Mateo	1	4	<b>VILLAVERA Darius</b>	0 - 10	0:13	IPO
D-36	LALIBERTÉ Dominik	2	3	<b>TREMBLAY james</b>	0 - 10	1:54	IPO

## Résultats/Results

Pos	Nom/Name
1	VILLAVERA Darius, Bushidokan
2	RÉGLAT-ARZATE Mateo, Lachenaie
3	TREMBLAY james, Seiko

# U12M pool 19

## Compétiteurs/Competitors

#	Nom/Name	Grade	Club	1	2	3	4	G/W	Pts	Pos
1	SIMARD Albert	4k+	Judo-Tech	XX				0	0	4
2	MANIL-BOUCHARD Nicolas	4k+	Ju Shin Kan	10	XX	10	10	3	30	1
3	BOUCHARD Jean-David	2k	Fermont	10		XX	10	2	20	2
4	MAZOUZI OMAR	5k	Judo-La Pocatiere	10			XX	1	10	3

## Matches/Matches

Match	Blanc/White			Bleu/Blue	Rés/Res	Tmp/Tim	Code
E-19	SIMARD Albert	1	2	MANIL-BOUCHARD Nicolas	0 - 10	0:28	WIP
E-20	BOUCHARD Jean-David	3	4	MAZOUZI OMAR	10 - 0	0:47	IPO
E-25	SIMARD Albert	1	3	BOUCHARD Jean-David	0 - 10	0:44	IPO
E-26	MANIL-BOUCHARD Nicolas	2	4	MAZOUZI OMAR	10 - 0	0:40	IPO
E-31	SIMARD Albert	1	4	MAZOUZI OMAR	0 - 10	0:39	WIP
E-32	MANIL-BOUCHARD Nicolas	2	3	BOUCHARD Jean-David	10 - 0	1:13	IPO

## Résultats/Results

Pos	Nom/Name
1	MANIL-BOUCHARD Nicolas, Ju Shin Kan
2	BOUCHARD Jean-David, Fermont
3	MAZOUZI OMAR, Judo-La Pocatiere

# U12M pool 2

## Compétiteurs/Competitors

#	Nom/Name	Grade	Club	1	2	3	4	G/W	Pts	Pos
1	GIRARD Samuel	4k	Jonquière	XX		10		1	10	3
2	PAQUET Émile	5k+	Albatros	10	XX		10	2	20	1
3	FRANCOEUR-CÔTÉ Elie	5k+	Judo-Tech		1	XX	10	2	11	2
4	TREMBLAY Vincent	3k+	Port Cartier	5			XX	1	5	4

## Matches/Matches

Match	Blanc/White			Bleu/Blue	Rés/Res	Tmp/Tim	Code
B-5	GIRARD Samuel	1	2	PAQUET Émile	0 - 10	1:48	WIP
B-6	FRANCOEUR-CÔTÉ Elie	3	4	TREMBLAY Vincent	10 - 0	1:22	WIP
B-11	GIRARD Samuel	1	3	FRANCOEUR-CÔTÉ Elie	10 - 0	2:00	IPO
B-12	PAQUET Émile	2	4	TREMBLAY Vincent	10 - 0	1:00	WIP
B-17	GIRARD Samuel	1	4	TREMBLAY Vincent	0 - 5	2:00	WAZ
B-18	PAQUET Émile	2	3	FRANCOEUR-CÔTÉ Elie	0 - 1	2:00	YUS

## Résultats/Results

Pos	Nom/Name
1	PAQUET Émile, Albatros
2	FRANCOEUR-CÔTÉ Elie, Judo-Tech
3	GIRARD Samuel, Jonquière
4	TREMBLAY Vincent, Port Cartier

# U12M pool 20

## Compétiteurs/Competitors

#	Nom/Name	Grade	Club	1	2	3	4	G/W	Pts	Pos
1	SMITH Henri	4k	Vieille-Capitale	XX		10		1	10	3
2	TERRIEN Félix	4k	Albatros	10	XX	10	10	3	30	1
3	BERNATCHEZ JÉRÉMY	4k	Vallée Judo Dojo			XX		0	0	4
4	GALLIEN Guillaume	5k+	Judo Monde	10		10	XX	2	20	2

## Matches/Matches

Match	Blanc/White			Bleu/Blue	Rés/Res	Tmp/Tim	Code
E-21	SMITH Henri	1	2	TERRIEN Félix	0 - 10	0:04	IPO
E-22	BERNATCHEZ JÉRÉMY	3	4	GALLIEN Guillaume	0 - 10	0:19	WIP
E-27	<b>SMITH Henri</b>	1	3	BERNATCHEZ JÉRÉMY	10 - 0	0:52	WIP
E-28	<b>TERRIEN Félix</b>	2	4	GALLIEN Guillaume	10 - 0	0:36	IPO
E-33	SMITH Henri	1	4	<b>GALLIEN Guillaume</b>	0 - 10	1:38	IPO
E-34	<b>TERRIEN Félix</b>	2	3	BERNATCHEZ JÉRÉMY	10 - 0	0:04	IPO

## Résultats/Results

Pos	Nom/Name
1	TERRIEN Félix, Albatros
2	GALLIEN Guillaume, Judo Monde
3	SMITH Henri, Vieille-Capitale

# U12M pool 21

## Compétiteurs/Competitors

#	Nom/Name	Grade	Club	1	2	3	4	G/W	Pts	Pos
1	SILEM Mohamed Amine	4k+	Torii	XX	10	10	10	3	30	1
2	CHIASSEON Vincent	5k	Gaspé		XX			0	0	4
3	BANVILLE Zakary	5k+	Rikidokan		10	XX		1	10	3
4	LAPORTE Benjamin	5k+	Kime-Waza		10	10	XX	2	20	2

## Matches/Matches

Match	Blanc/White			Bleu/Blue	Rés/Res	Tmp/Tim	Code
E-23	<b>SILEM Mohamed Amine</b>	1	2	CHIASSEON Vincent	10 - 0	0:06	IPO
E-24	BANVILLE Zakary	3	4	<b>LAPORTE Benjamin</b>	0 - 10	0:17	WIP
E-29	<b>SILEM Mohamed Amine</b>	1	3	BANVILLE Zakary	10 - 0	0:20	WIP
E-30	CHIASSEON Vincent	2	4	<b>LAPORTE Benjamin</b>	0 - 10	0:09	IPO
E-35	<b>SILEM Mohamed Amine</b>	1	4	LAPORTE Benjamin	10 - 0	0:24	IPO
E-36	CHIASSEON Vincent	2	3	<b>BANVILLE Zakary</b>	0 - 10	0:27	IPO

## Résultats/Results

Pos	Nom/Name
1	SILEM Mohamed Amine, Torii
2	LAPORTE Benjamin, Kime-Waza
3	BANVILLE Zakary, Rikidokan

# U12M pool 22

## Compétiteurs/Competitors

#	Nom/Name	Grade	Club	1	2	1	2	1	2	G/W	Pts	Pos
1	COULOMBE Isaac	4k	Sept-îles	XX		XX		XX		0	0	2
2	POWER Williamn	2k	Fermont	10	XX	10	XX		XX	2	20	1

## Matches/Matches

Match	Blanc/White			Bleu/Blue	Rés/Res	Tmp/Tim	Code
E-24A	COULOMBE Isaac	1	2	POWER Williamn	0 - 10	1:08	IPO
E-30A	POWER Williamn	2	1	COULOMBE Isaac	10 - 0	1:59	WIP
E-36A	COULOMBE Isaac	1	2	POWER Williamn			

## Résultats/Results

Pos	Nom/Name
1	POWER Williamn, Fermont



# U12M pool 3

## Compétiteurs/Competitors

#	Nom/Name	Grade	Club	1	2	3	4	G/W	Pts	Pos
1	LEROUX Thomas	5k	Hontaï Dojo	XX				0	0	4
2	DROLET Noah	2k	Sept-îles	10	XX		10	2	20	2
3	OUELLET Alex	4k	Albatros	10	10	XX	10	3	30	1
4	GOBEIL Théo	5k+	Chicoutimi	10			XX	1	10	3

## Matches/Matches

Match	Blanc/White			Bleu/Blue	Rés/Res	Tmp/Tim	Code
C-5	LEROUX Thomas	1	2	DROLET Noah	0 - 10	0:42	IPO
C-6	<b>OUELLET Alex</b>	3	4	GOBEIL Théo	10 - 0	1:52	IPO
C-11	LEROUX Thomas	1	3	<b>OUELLET Alex</b>	0 - 10	0:03	IPO
C-12	<b>DROLET Noah</b>	2	4	GOBEIL Théo	10 - 0	1:41	IPO
C-17	LEROUX Thomas	1	4	<b>GOBEIL Théo</b>	0 - 10	0:05	IPO
C-18	DROLET Noah	2	3	<b>OUELLET Alex</b>	0 - 10	0:14	IPO

## Résultats/Results

Pos	Nom/Name
1	OUELLET Alex, Albatros
2	DROLET Noah, Sept-îles
3	GOBEIL Théo, Chicoutimi

# U12M pool 4

## Compétiteurs/Competitors

#	Nom/Name	Grade	Club	1	2	3	4	G/W	Pts	Pos
1	LABELLE Max-Olivier	4k	Sept-îles	XX			10	1	10	3
2	NÉRON Joey	5k+	Albatros	10	XX	10	10	3	30	1
3	BROUILLETTE Xavier	4k+	Seikidokan	10		XX	10	2	20	2
4	LEBEL Olivier	4k	Baie-Comeau				XX	0	0	4

## Matches/Matches

Match	Blanc/White			Bleu/Blue	Rés/Res	Tmp/Tim	Code
D-5	LABELLE Max-Olivier	1	2	NÉRON Joey	0 - 10	0:40	WIP
D-6	<b>BROUILLETTE Xavier</b>	3	4	LEBEL Olivier	10 - 0	0:40	IPO
D-11	LABELLE Max-Olivier	1	3	<b>BROUILLETTE Xavier</b>	0 - 10	1:14	IPO
D-12	<b>NÉRON Joey</b>	2	4	LEBEL Olivier	10 - 0	0:20	WIP
D-17	<b>LABELLE Max-Olivier</b>	1	4	LEBEL Olivier	10 - 0	0:09	IPO
D-18	<b>NÉRON Joey</b>	2	3	BROUILLETTE Xavier	10 - 0	1:52	IPO

## Résultats/Results

Pos	Nom/Name
1	NÉRON Joey, Albatros
2	BROUILLETTE Xavier, Seikidokan
3	LABELLE Max-Olivier, Sept-îles

# U12M pool 5

## Compétiteurs/Competitors

#	Nom/Name	Grade	Club	1	2	3	4	G/W	Pts	Pos
1	ROBERGE POITRAS Samuel	5k	Baie-Comeau	XX		10	10	2	20	2
2	LABERGE Anthony	4k+	Jonquière	10	XX	10	10	3	30	1
3	DUNLEVY Tenzin	5k+	Bushidokan			XX	10	1	10	3
4	GARON Philippe	5k	Rikidokan				XX	0	0	4

## Matches/Matches

Match	Blanc/White			Bleu/Blue	Rés/Res	Tmp/Tim	Code
E-3	ROBERGE POITRAS Samuel	1	2	LABERGE Anthony	0 - 10	1:16	IPO
E-4	DUNLEVY Tenzin	3	4	GARON Philippe	10 - 0	1:00	WIP
E-9	ROBERGE POITRAS Samuel	1	3	DUNLEVY Tenzin	10 - 0	1:06	IPO
E-10	LABERGE Anthony	2	4	GARON Philippe	10 - 0	0:09	IPO
E-15	ROBERGE POITRAS Samuel	1	4	GARON Philippe	10 - 0	0:22	IPO
E-16	LABERGE Anthony	2	3	DUNLEVY Tenzin	10 - 0	0:01	IPO

## Résultats/Results

Pos	Nom/Name
1	LABERGE Anthony, Jonquière
2	ROBERGE POITRAS Samuel, Baie-Comeau
3	DUNLEVY Tenzin, Bushidokan

# U12M pool 6

## Compétiteurs/Competitors

#	Nom/Name	Grade	Club	1	2	3	4	G/W	Pts	Pos
1	LIZOTTE Mathis-Olivier	5k+	Judo-La Pocatiere	XX	10	10		2	20	2
2	MERCIER Loik	4k+	Port Cartier		XX			0	0	4
3	GIROUX Charlie	4k	Vallée Judo Dojo		10	XX		1	10	3
4	BARRIAULT-TREMBLAY Noam	4k+	Jonquière	10	10	10	XX	3	30	1

## Matches/Matches

Match	Blanc/White			Bleu/Blue	Rés/Res	Tmp/Tim	Code
E-5	<b>LIZOTTE Mathis-Olivier</b>	1	2	MERCIER Loik	10 - 0	1:26	WIP
E-6	GIROUX Charlie	3	4	<b>BARRIAULT-TREMBLAY Noam</b>	0 - 10	0:46	IPO
E-11	<b>LIZOTTE Mathis-Olivier</b>	1	3	GIROUX Charlie	10 - 0	0:01	IPO
E-12	MERCIER Loik	2	4	<b>BARRIAULT-TREMBLAY Noam</b>	0 - 10	1:38	IPO
E-17	LIZOTTE Mathis-Olivier	1	4	<b>BARRIAULT-TREMBLAY Noam</b>	0 - 10	1:44	IPO
E-18	MERCIER Loik	2	3	<b>GIROUX Charlie</b>	0 - 10	0:01	FUS

## Résultats/Results

Pos	Nom/Name
1	BARRIAULT-TREMBLAY Noam, Jonquière
2	LIZOTTE Mathis-Olivier, Judo-La Pocatiere
3	GIROUX Charlie, Vallée Judo Dojo

# U12M pool 7

## Compétiteurs/Competitors

#	Nom/Name	Grade	Club	1	2	3	4	G/W	Pts	Pos
1	BEAULAC Isaac	5k+	Seikidokan	XX				0	0	4
2	GIRARD Élie	4k+	St-Paul l'Ermite	10	XX			1	10	3
3	TRUDEL Léo	3k+	Port Cartier	10	10	XX		2	20	2
4	GUÉRAULT Dominic	3k	Sept-îles	10	10	10	XX	3	30	1

## Matches/Matches

Match	Blanc/White			Bleu/Blue	Rés/Res	Tmp/Tim	Code
A-19	BEAULAC Isaac	1	2	GIRARD Élie	0 - 10	0:35	IPO
A-20	TRUDEL Léo	3	4	GUÉRAULT Dominic	0 - 10	1:02	IPO
A-25	BEAULAC Isaac	1	3	TRUDEL Léo	0 - 10	0:37	WIP
A-26	GIRARD Élie	2	4	GUÉRAULT Dominic	0 - 10	0:57	IPO
A-31	BEAULAC Isaac	1	4	GUÉRAULT Dominic	0 - 10	0:24	IPO
A-32	GIRARD Élie	2	3	TRUDEL Léo	0 - 10	0:09	IPO

## Résultats/Results

Pos	Nom/Name
1	GUÉRAULT Dominic, Sept-îles
2	TRUDEL Léo, Port Cartier
3	GIRARD Élie, St-Paul l'Ermite

# U12M pool 8

## Compétiteurs/Competitors

#	Nom/Name	Grade	Club	1	2	3	4	G/W	Pts	Pos
1	THIBAUT Justin	4k+	Seikidokan	XX		10		1	10	3
2	ALLAIRE Nicolas	4k+	Seikidokan	10	XX			1	10	2
3	VAILLANCOURT Mathis	5k+	Fermont		5	XX		1	5	4
4	DUBÉ Jérôme	4k+	Jonquière	10	10	10	XX	3	30	1

## Matches/Matches

Match	Blanc/White			Bleu/Blue	Rés/Res	Tmp/Tim	Code
A-21	THIBAUT Justin	1	2	ALLAIRE Nicolas	0 - 10	0:23	WIP
A-22	VAILLANCOURT Mathis	3	4	DUBÉ Jérôme	0 - 10	1:47	WIP
A-27	<b>THIBAUT Justin</b>	1	3	VAILLANCOURT Mathis	10 - 0	1:16	IPO
A-28	ALLAIRE Nicolas	2	4	DUBÉ Jérôme	0 - 10	0:29	IPO
A-33	THIBAUT Justin	1	4	DUBÉ Jérôme	0 - 10	0:07	IPO
A-34	ALLAIRE Nicolas	2	3	VAILLANCOURT Mathis	0 - 5	2:00	WAZ

## Résultats/Results

Pos	Nom/Name
1	DUBÉ Jérôme, Jonquière
2	ALLAIRE Nicolas, Seikidokan
3	THIBAUT Justin, Seikidokan
4	VAILLANCOURT Mathis, Fermont

# U12M pool 9

## Compétiteurs/Competitors

#	Nom/Name	Grade	Club	1	2	3	4	G/W	Pts	Pos
1	BOURQUE Tristan	4k	Boucherville	XX	5	10	10	3	25	1
2	LABERGE Alexis	5k	Jonquière		XX	10	10	2	20	2
3	TALBOT Machiel	4k+	Baie-Comeau			XX	10	1	10	3
4	DUMONT Lou	3k	Judo-Tani				XX	0	0	4

## Matches/Matches

Match	Blanc/White			Bleu/Blue	Rés/Res	Tmp/Tim	Code
A-23	BOURQUE Tristan	1	2	LABERGE Alexis	5 - 0	2:00	WAZ
A-24	TALBOT Machiel	3	4	DUMONT Lou	10 - 0	1:37	IPO
A-29	BOURQUE Tristan	1	3	TALBOT Machiel	10 - 0	0:16	IPO
A-30	LABERGE Alexis	2	4	DUMONT Lou	10 - 0	1:30	IPO
A-35	BOURQUE Tristan	1	4	DUMONT Lou	10 - 0	0:34	IPO
A-36	LABERGE Alexis	2	3	TALBOT Machiel	10 - 0	2:00	IPO

## Résultats/Results

Pos	Nom/Name
1	BOURQUE Tristan, Boucherville
2	LABERGE Alexis, Jonquière
3	TALBOT Machiel, Baie-Comeau

# Newaza lourd

## Compétiteurs/Competitors

#	Nom/Name	Grade	Club	1	2	3	4	G/W	Pts	Pos
1	PELLETIER Christopher	1k	Amqui	XX				0	0	4
2	PAQUET Marc-André	1k	Amqui	10	XX			1	10	3
3	BADAT Thomas	1D	Judo Victo	10	10	XX		2	20	2
4	COTE Maxim	1D	Sept-Iles	10	10	10	XX	3	30	1

## Matches/Matches

Match	Blanc/White			Bleu/Blue	Rés/Res	Tmp/Tim	Code
E-30	PELLETIER Christopher	1	2	PAQUET Marc-André	0 - 10	2:49	IPO
E-31	BADAT Thomas	3	4	COTE Maxim	0 - 10	0:01	IPO
E-32	PELLETIER Christopher	1	3	BADAT Thomas	0 - 10	3:38	IPO
E-33	PAQUET Marc-André	2	4	COTE Maxim	0 - 10	1:27	IPO
E-34	PELLETIER Christopher	1	4	COTE Maxim	0 - 10	1:25	IPO
E-35	PAQUET Marc-André	2	3	BADAT Thomas	0 - 10	0:00	IPO

## Résultats/Results

Pos	Nom/Name
1	COTE Maxim, Sept-Iles
2	BADAT Thomas, Judo Victo
3	PAQUET Marc-André, Amqui



# U14F -36JO

## Compétiteurs/Competitors

#	Nom/Name	Grade	Club	1	2	3	G/W	Pts	Pos
1	PAUL Marie-anne	4k+	Torakai	XX		10	1	10	2
2	GAUTHIER Catherine	4k+	Albatros	10	XX	10	2	20	1
3	PERREAULT Émilie-Anne	4k	Amqui			XX	0	0	3

## Matches/Matches

Match	Blanc/White			Bleu/Blue	Rés/Res	Tmp/Tim	Code
E-15	PAUL Marie-anne	1	2	GAUTHIER Catherine	0 - 10	0:01	IPO
E-20	PAUL Marie-anne	1	3	PERREAULT Émilie-Anne	10 - 0	0:33	IPO
E-27	GAUTHIER Catherine	2	3	PERREAULT Émilie-Anne	10 - 0	0:01	IPO

## Résultats/Results

Pos	Nom/Name
1	GAUTHIER Catherine, Albatros
2	PAUL Marie-anne, Torakai

# U14F -40JO

## Compétiteurs/Competitors

#	Nom/Name	Grade	Club	1	2	3	G/W	Pts	Pos
1	GARCEAU Jade	4k	Shawinigan	XX	10		1	10	2
2	LA VERGNE Zoé	4k	CJVR		XX		0	0	3
3	DUBÉ Océane	4k+	Donini/Univestrie	10	10	XX	2	20	1

## Matches/Matches

Match	Blanc/White			Bleu/Blue	Rés/Res	Tmp/Tim	Code
D-18	<b>GARCEAU Jade</b>	1	2	LA VERGNE Zoé	10 - 0	0:38	WIP
D-28	GARCEAU Jade	1	3	<b>DUBÉ Océane</b>	0 - 10	0:01	IPO
D-40	LA VERGNE Zoé	2	3	<b>DUBÉ Océane</b>	0 - 10	1:53	WIP

## Résultats/Results

Pos	Nom/Name
1	DUBÉ Océane, Donini/Univestrie
2	GARCEAU Jade, Shawinigan

# U14F -40V+

## Compétiteurs/Competitors

#	Nom/Name	Grade	Club	1	2	3	4	5	G/W	Pts	Pos
1	FERRON Magaly	3k+	Fermont	XX					0	0	5
2	GAGNON Naomie	2k	Sept-îles	10	XX				1	10	4
3	LANGLAIS Marissa	3k+	Judo-Tech	10	10	XX			2	20	3
4	GAGNON Laurence	3k+	Jonquière	10	10	10	XX	5	4	35	1
5	CÔTÉ Aurélie	3k+	Jonquière	10	10	10		XX	3	30	2

## Matches/Matches

Match	Blanc/White			Bleu/Blue	Rés/Res	Tmp/Tim	Code
A-7	<b>GAGNON Laurence</b>	4	5	CÔTÉ Aurélie	5 - 0	0:21	WAZ
A-8	FERRON Magaly	1	2	<b>GAGNON Naomie</b>	0 - 10	1:26	WIP
A-15	LANGLAIS Marissa	3	4	<b>GAGNON Laurence</b>	0 - 10	0:19	IPO
A-16	FERRON Magaly	1	5	<b>CÔTÉ Aurélie</b>	0 - 10	0:34	WIP
A-26	GAGNON Naomie	2	3	<b>LANGLAIS Marissa</b>	0 - 10	0:51	WIP
A-27	FERRON Magaly	1	4	<b>GAGNON Laurence</b>	0 - 10	0:19	IPO
A-36	LANGLAIS Marissa	3	5	<b>CÔTÉ Aurélie</b>	0 - 10	0:41	IPO
A-37	GAGNON Naomie	2	4	<b>GAGNON Laurence</b>	0 - 10	1:03	WIP
A-48	FERRON Magaly	1	3	<b>LANGLAIS Marissa</b>	0 - 10	0:56	WIP
A-49	GAGNON Naomie	2	5	<b>CÔTÉ Aurélie</b>	0 - 10	0:31	WIP

## Résultats/Results

Pos	Nom/Name
1	GAGNON Laurence, Jonquière
2	CÔTÉ Aurélie, Jonquière
3	LANGLAIS Marissa, Judo-Tech
4	GAGNON Naomie, Sept-îles

# U14F -44V+

## Compétiteurs/Competitors

#	Nom/Name	Grade	Club	1	2	3	4	G/W	Pts	Pos
1	TOSHKOV Catherine	3k	Boucherville	XX	10	10	10	3	30	1
2	BONIN Ariane	3k+	Boucherville		XX			0	0	4
3	CHAMPAGNE Marguerite	3k	St-Hyacinthe		10	XX		1	10	3
4	SAVARD Meagan	2k	Jonquière		10	10	XX	2	20	2

## Matches/Matches

Match	Blanc/White			Bleu/Blue	Rés/Res	Tmp/Tim	Code
B-19	<b>TOSHKOV Catherine</b>	1	2	BONIN Ariane	10 - 0	0:47	IPO
B-20	CHAMPAGNE Marguerite	3	4	<b>SAVARD Meagan</b>	0 - 10	0:05	IPO
B-30	<b>TOSHKOV Catherine</b>	1	3	CHAMPAGNE Marguerite	10 - 0	0:23	WIP
B-31	BONIN Ariane	2	4	<b>SAVARD Meagan</b>	0 - 10	0:20	IPO
B-43	<b>TOSHKOV Catherine</b>	1	4	SAVARD Meagan	10 - 0	1:52	IPO
B-44	BONIN Ariane	2	3	<b>CHAMPAGNE Marguerite</b>	0 - 10	2:53	IPO

## Résultats/Results

Pos	Nom/Name
1	TOSHKOV Catherine, Boucherville
2	SAVARD Meagan, Jonquière
3	CHAMPAGNE Marguerite, St-Hyacinthe

# U14F -48JO

## Compétiteurs/Competitors A

#	Nom/Name	Grade	Club	1	2	3	4	G/W	Pts	Pos
1	RAHAL Amina	4k+	Shidokan	XX				0	0	4
2	DA COSTA CORREIA Inês	4k+	Boucherville	10	XX	10	10	3	30	1
3	HAUG Malika	4k+	Donini/Univestrie	10		XX	10	2	20	2
4	DUBÉ Angelica	4k	Judo-Tech	10			XX	1	10	3

## Matches/Matches A

Match	Blanc/White	Bleu/Blue	Rés/Res	Tmp/Tim	Code
1	RAHAL Amina	DA COSTA CORREIA Inês	0 - 10	0:00	FUS
C-30	HAUG Malika	DUBÉ Angelica	10 - 0	0:57	IPO
4	RAHAL Amina	HAUG Malika	0 - 10	0:00	FUS
C-39	DA COSTA CORREIA Inês	DUBÉ Angelica	10 - 0	1:01	WIP
7	RAHAL Amina	DUBÉ Angelica	0 - 10	0:00	FUS
C-46	DA COSTA CORREIA Inês	HAUG Malika	10 - 0	0:34	WIP

## Compétiteurs/Competitors B

#	Nom/Name	Grade	Club	5	6	7	G/W	Pts	Pos
5	DUSSAULT Leanne	4k+	Asbestos	XX	10	10	2	20	1
6	HAINAULT Émy	4k	Boucherville		XX		0	0	3
7	FORTIN Marie joelle	4k+	Baie-Comeau		10	XX	1	10	2

## Matches/Matches B

Match	Blanc/White	Bleu/Blue	Rés/Res	Tmp/Tim	Code
C-31	DUSSAULT Leanne	HAINAULT Émy	10 - 0	2:16	WIP
C-40	DUSSAULT Leanne	FORTIN Marie joelle	10 - 0	0:54	IPO
C-47	HAINAULT Émy	FORTIN Marie joelle	0 - 10	2:31	WIP

### DA COSTA CORREIA

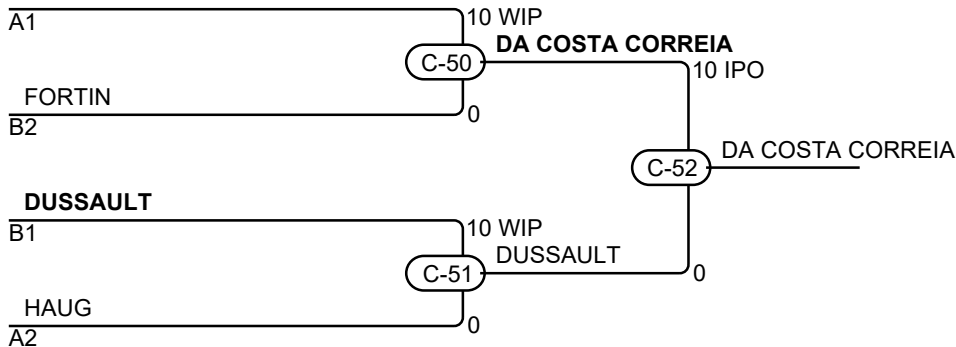

## Résultats/Results

Pos	Nom/Name
1	DA COSTA CORREIA Inês, Boucherville
2	DUSSAULT Leanne, Asbestos
3	FORTIN Marie joelle, Baie-Comeau
3	HAUG Malika, Donini/Univestrie

# U14F -48V+

## Compétiteurs/Competitors

#	Nom/Name	Grade	Club	1	2	3	4	G/W	Pts	Pos
1	BÉRIAULT Genevieve	3k	Bushidokan	XX			10	1	10	3
2	DESSUREAULT Olivia	2k	Jonquière	10	XX	10	10	3	30	1
3	MARTINEAU Marjorie	2k	Chicoutimi	10		XX	1	2	11	2
4	BELLAVANCE Alyssa	3k	St-Hyacinthe				XX	0	0	4

## Matches/Matches

Match	Blanc/White			Bleu/Blue	Rés/Res	Tmp/Tim	Code
A-19	BÉRIAULT Genevieve	1	2	DESSUREAULT Olivia	0 - 10	0:14	IPO
A-20	MARTINEAU Marjorie	3	4	BELLAVANCE Alyssa	1 - 0	3:00	YUS
A-31	BÉRIAULT Genevieve	1	3	MARTINEAU Marjorie	0 - 10	0:43	IPO
A-32	DESSUREAULT Olivia	2	4	BELLAVANCE Alyssa	10 - 0	0:47	IPO
A-41	BÉRIAULT Genevieve	1	4	BELLAVANCE Alyssa	10 - 0	0:21	WIP
A-42	DESSUREAULT Olivia	2	3	MARTINEAU Marjorie	10 - 0	0:05	IPO

## Résultats/Results

Pos	Nom/Name
1	DESSUREAULT Olivia, Jonquière
2	MARTINEAU Marjorie, Chicoutimi
3	BÉRIAULT Genevieve, Bushidokan

# U14F -57JO

## Compétiteurs/Competitors A

#	Nom/Name	Grade	Club	1	2	3	G/W	Pts	Pos
1	BEAULIEU-JALBERT Marie-Ann	5k	Amqui	XX			0	0	3
2	PERKINSON Méloïze	5k	CJVR	10	XX		1	10	2
3	LAVIGNE Frédérique	4k+	Métropolitain	10	10	XX	2	20	1

## Matches/Matches A

Match	Blanc/White			Bleu/Blue	Rés/Res	Tmp/Tim	Code
E-8	BEAULIEU-JALBERT Marie-Ann	1	2	PERKINSON Méloïze	0 - 10	0:48	WIP
E-16	BEAULIEU-JALBERT Marie-Ann	1	3	LAVIGNE Frédérique	0 - 10	0:07	IPO
E-21	PERKINSON Méloïze	2	3	LAVIGNE Frédérique	0 - 10	1:32	WIP

## Compétiteurs/Competitors B

#	Nom/Name	Grade	Club	4	5	6	G/W	Pts	Pos
4	DUHAIME Jessica	5k+	Ghishintaïdo	XX			0	0	3
5	VALLIÈRES Kénia	4k	Shawinigan	10	XX	10	2	20	1
6	GENDRON Rosalie	5k	Amqui	10		XX	1	10	2

## Matches/Matches B

Match	Blanc/White			Bleu/Blue	Rés/Res	Tmp/Tim	Code
E-9	DUHAIME Jessica	4	5	VALLIÈRES Kénia	0 - 10	2:49	WIP
E-17	DUHAIME Jessica	4	6	GENDRON Rosalie	0 - 10	1:42	HAN
E-22	VALLIÈRES Kénia	5	6	GENDRON Rosalie	10 - 0	0:01	WIP

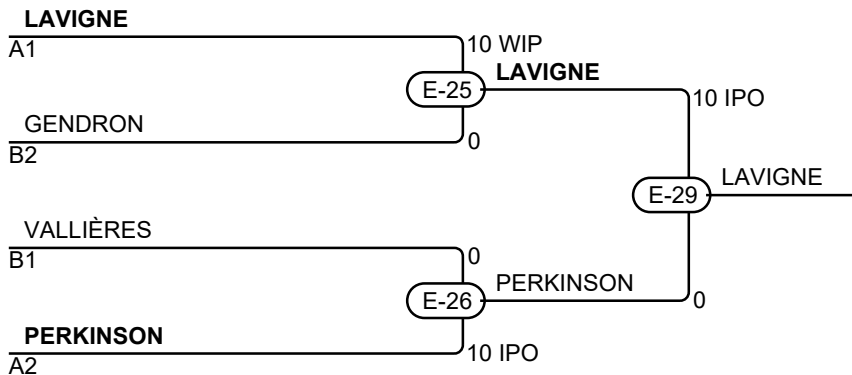

## Résultats/Results

Pos	Nom/Name
1	LAVIGNE Frédérique, Métropolitain
2	PERKINSON Méloïze, CJVR
3	GENDRON Rosalie, Amqui
3	VALLIÈRES Kénia, Shawinigan

# U14F -57V+

## Compétiteurs/Competitors

#	Nom/Name	Grade	Club	1	2	3	G/W	Pts	Pos
1	NOCEDO-DUFOUR Selena	3k	Seikidokan	XX			0	0	3
2	ROBERTSON Loika	3k	St-Jean Bosco	10	XX	10	2	20	1
3	CHARNEAU Adèle	3k+	St-Paul l'Ermite	10		XX	1	10	2

## Matches/Matches

Match	Blanc/White			Bleu/Blue	Rés/Res	Tmp/Tim	Code
A-25	NOCEDO-DUFOUR Selena	1	2	ROBERTSON Loika	0 - 10	0:45	WIP
A-35	NOCEDO-DUFOUR Selena	1	3	CHARNEAU Adèle	0 - 10	0:47	IPO
A-47	ROBERTSON Loika	2	3	CHARNEAU Adèle	10 - 0	2:18	IPO

## Résultats/Results

Pos	Nom/Name
1	ROBERTSON Loika, St-Jean Bosco
2	CHARNEAU Adèle, St-Paul l'Ermite



# U14F +63V+

## Compétiteurs/Competitors

#	Nom/Name	Grade	Club	1	2	3	G/W	Pts	Pos
1	LÉVESQUE Mégan	5k+	Judo-La Pocatiere	XX			0	0	3
2	ST-ONGE Mélodie	3k+	Asbestos	10	XX	10	2	20	1
3	BOURQUE Kathie	4k	Ghishintaïdo	10		XX	1	10	2

## Matches/Matches

Match	Blanc/White			Bleu/Blue	Rés/Res	Tmp/Tim	Code
A-30	LÉVESQUE Mégan	1	2	ST-ONGE Mélodie	0 - 10	2:39	IPO
A-40	LÉVESQUE Mégan	1	3	BOURQUE Kathie	0 - 10	0:54	IPO
A-52	ST-ONGE Mélodie	2	3	BOURQUE Kathie	10 - 0	2:28	WIP

## Résultats/Results

Pos	Nom/Name
1	ST-ONGE Mélodie, Asbestos
2	BOURQUE Kathie, Ghishintaïdo

# U14M -31JO

## Compétiteurs/Competitors

#	Nom/Name	Grade	Club	1	2	1	2	1	2	G/W	Pts	Pos
1	JOHNSON Guillaume	4k	Judo-Tech	XX		XX		XX		0	0	2
2	GAGNON Jérémi	5k	Jonquière	10	XX	10	XX		XX	2	20	1

## Matches/Matches

Match	Blanc/White			Bleu/Blue	Rés/Res	Tmp/Tim	Code
D-19	JOHNSON Guillaume	1	2	GAGNON Jérémi	0 - 10	0:12	IPO
D-29	GAGNON Jérémi	2	1	JOHNSON Guillaume	10 - 0	1:31	IPO
D-41	JOHNSON Guillaume	1	2	GAGNON Jérémi			

## Résultats/Results

Pos	Nom/Name
1	GAGNON Jérémi, Jonquière

# U14M -31V+

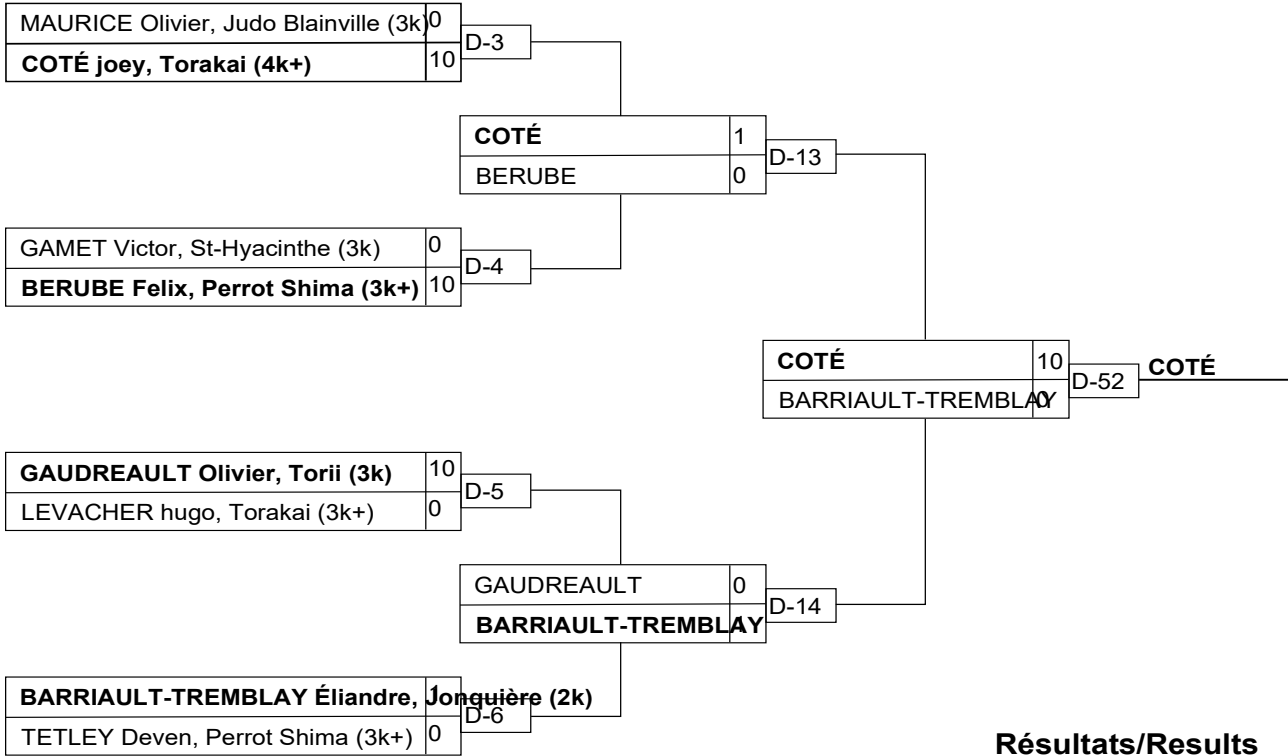

## Résultats/Results

Pos	Nom/Name
1	COTÉ joey, Torakai (4k+)
2	BARRIAULT-TREMBLAY Éliandre, Jonguière (2k)
3	BERUBE Felix, Perrot Shima (3k+)
3	GAUDREault Olivier, Torii (3k)

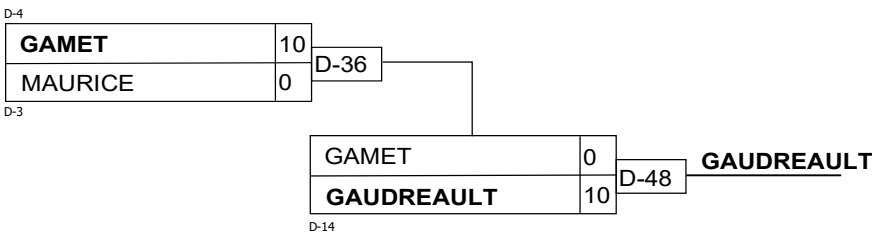
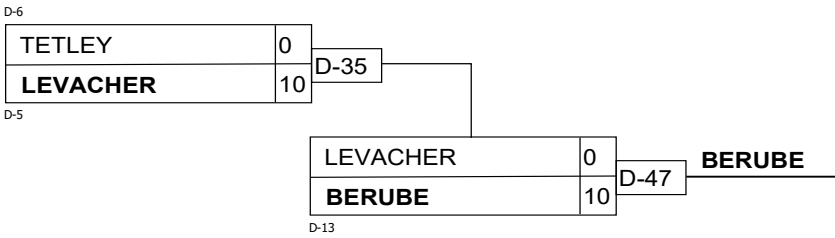

# U14M -34JO

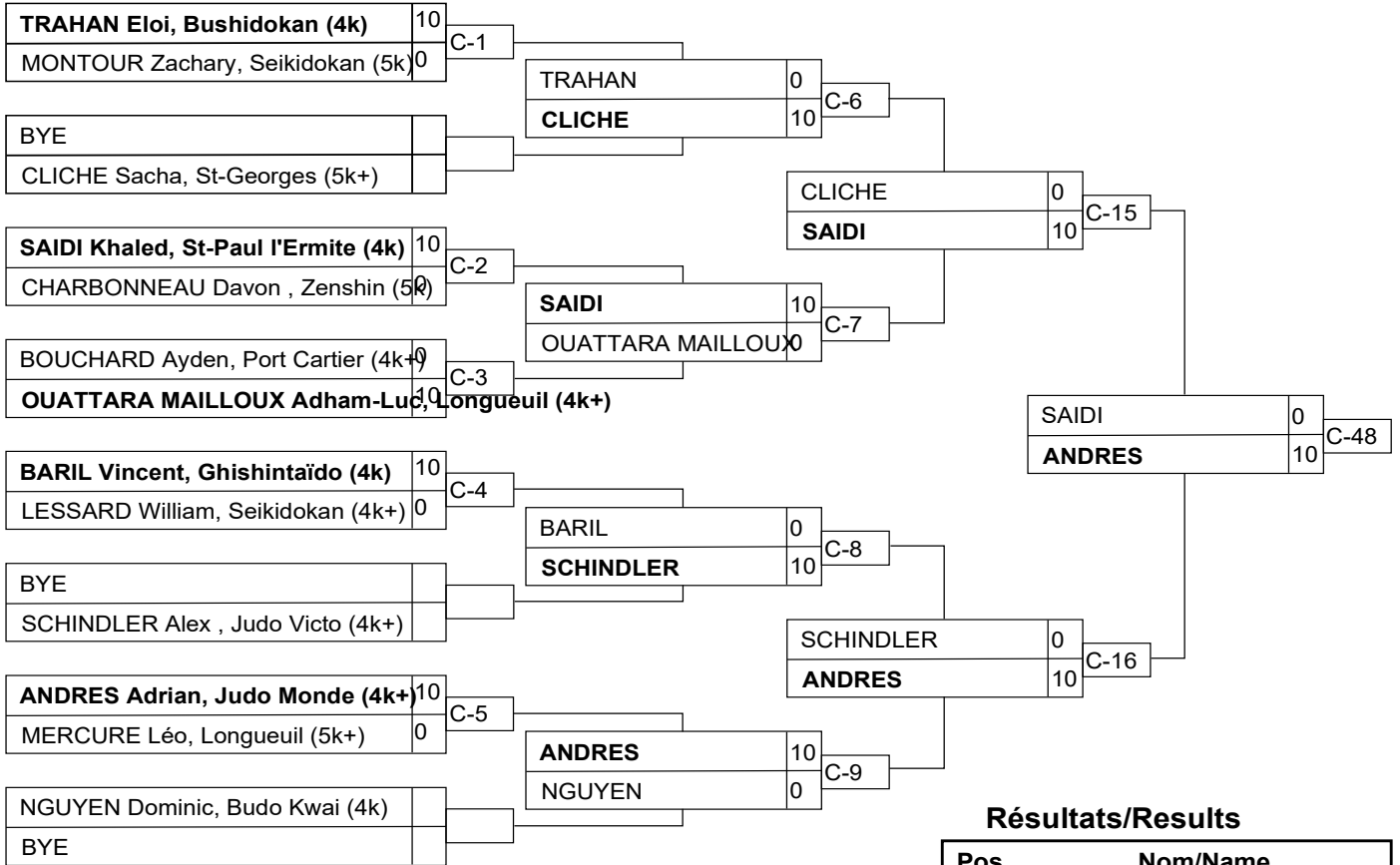

## Résultats/Results

Pos	Nom/Name
1	ANDRES Adrian, Judo Monde (4k+)
2	SAIDI Khaled, St-Paul l'Ermite (4k)
3	CHARBONNEAU Davon, Zenshin (5k)
3	SCHINDLER Alex, Judo Victo (4k+)

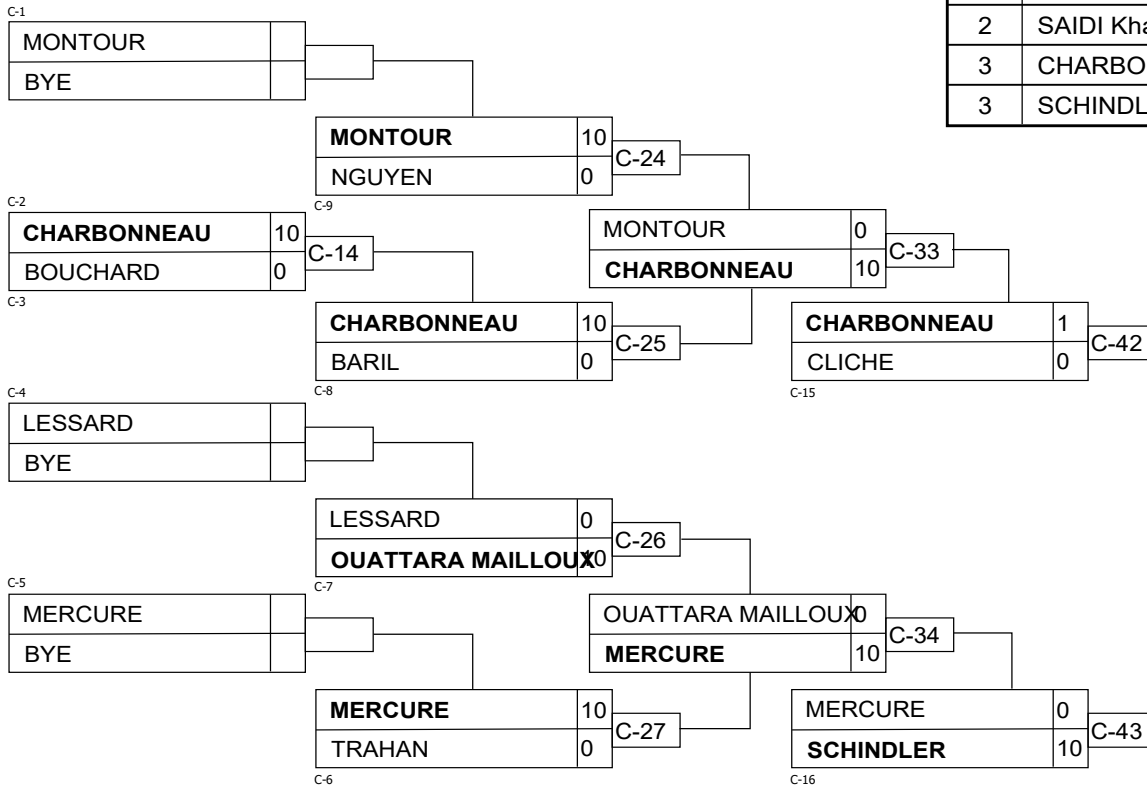

# U14M -34V+

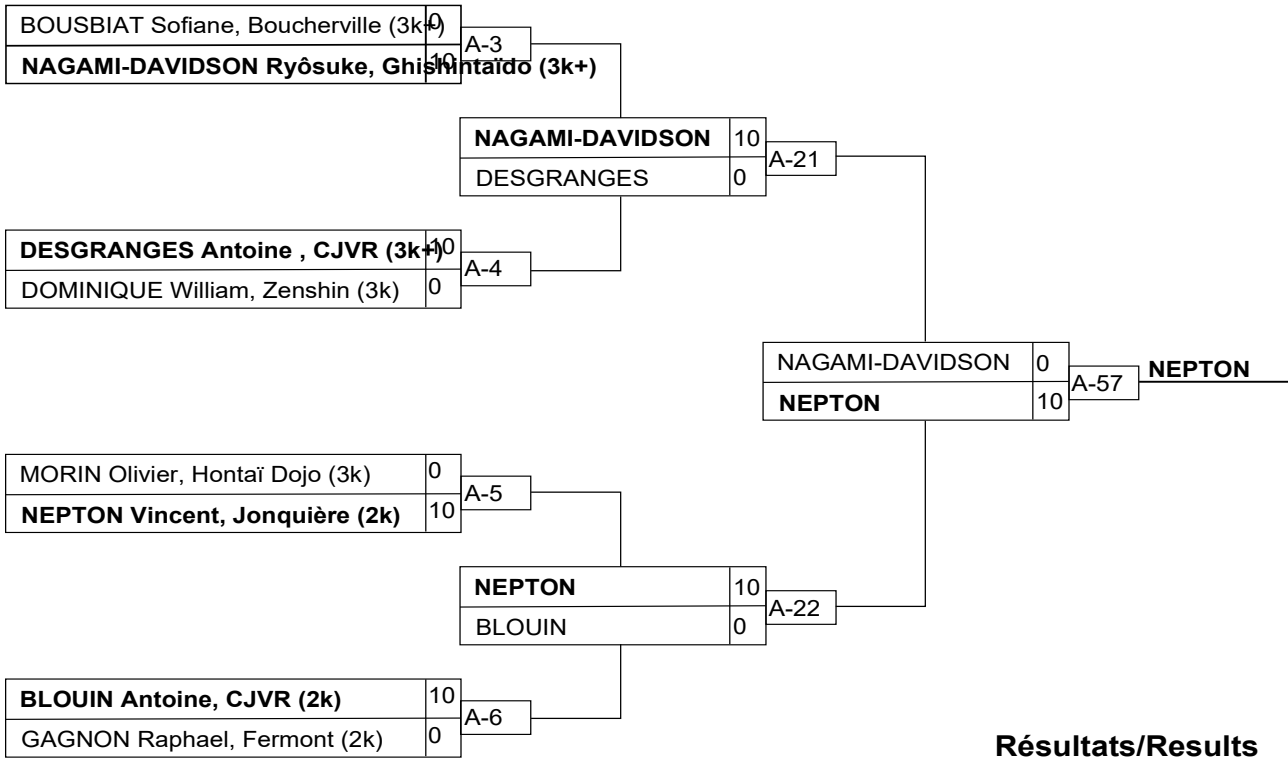

## Résultats/Results

Pos	Nom/Name
1	NEPTON Vincent, Jonquière (2k)
2	NAGAMI-DAVIDSON Ryôsuke, Ghishintaido (3k+)
3	GAGNON Raphael, Fermont (2k)
3	BLOUIN Antoine, CJVR (2k)

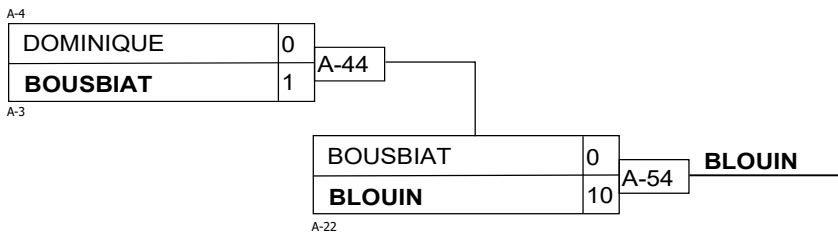
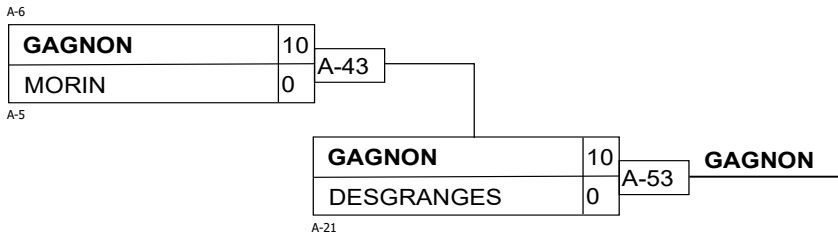

# U14M -38JO

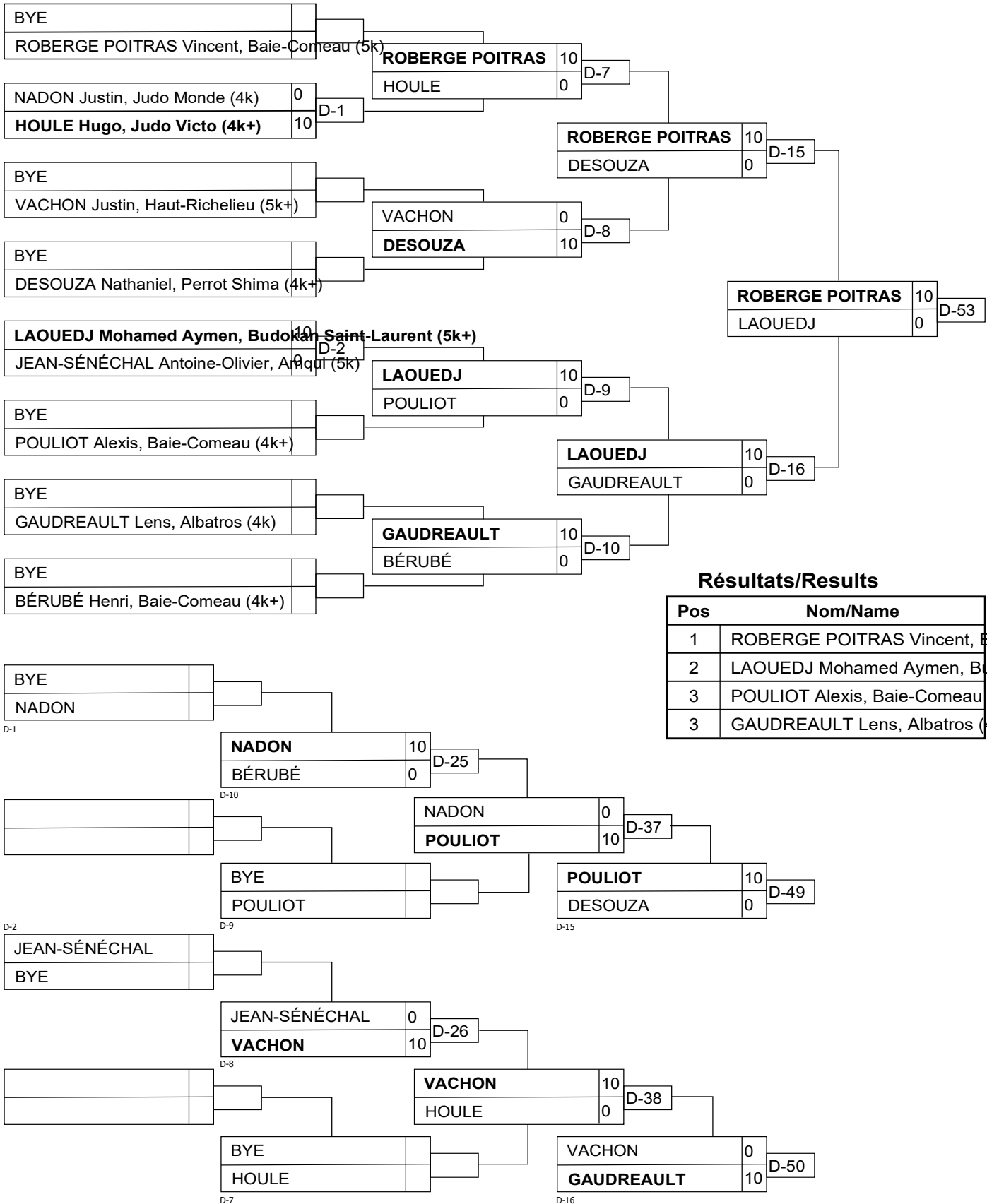

# U14M -38V+

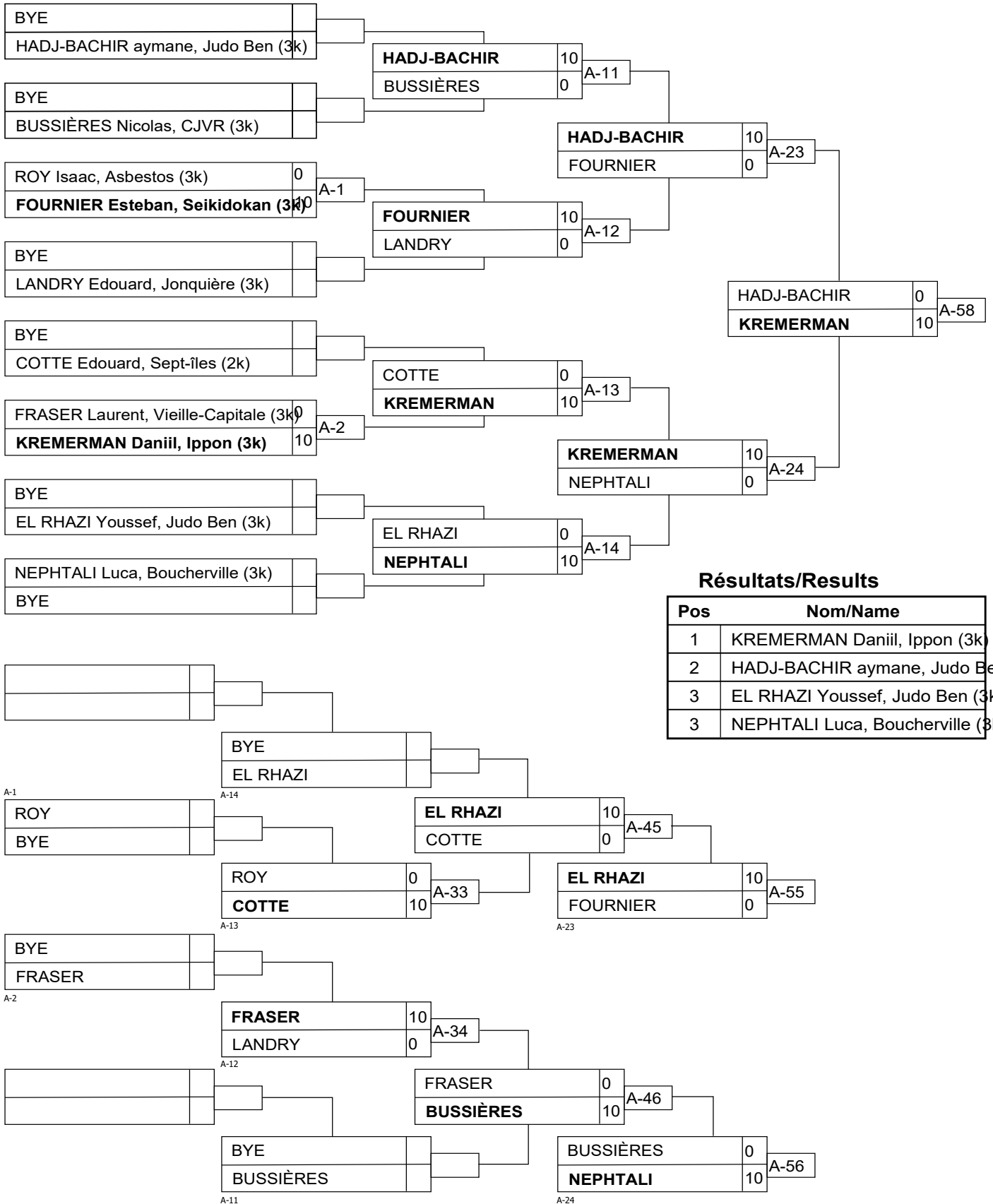

# U14M -42JO

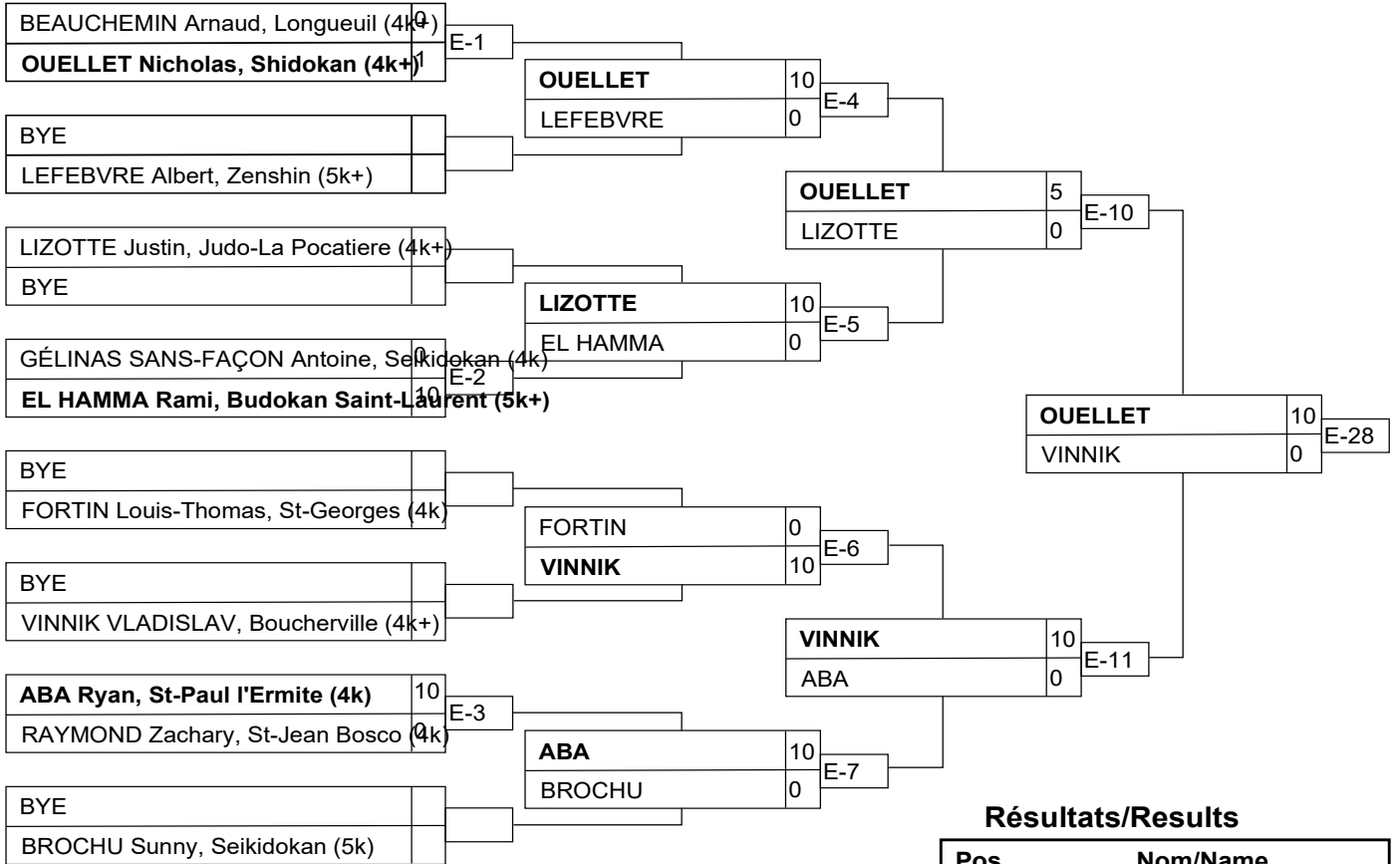

## Résultats/Results

Pos	Nom/Name
1	OUELLET Nicholas, Shidokan (4k+)
2	VINNIK VLADISLAV, Boucherville (4k+)
3	LIZOTTE Justin, Judo-La Pocatiere (4k+)
3	RAYMOND Zachary, St-Jean Bosco (4k)

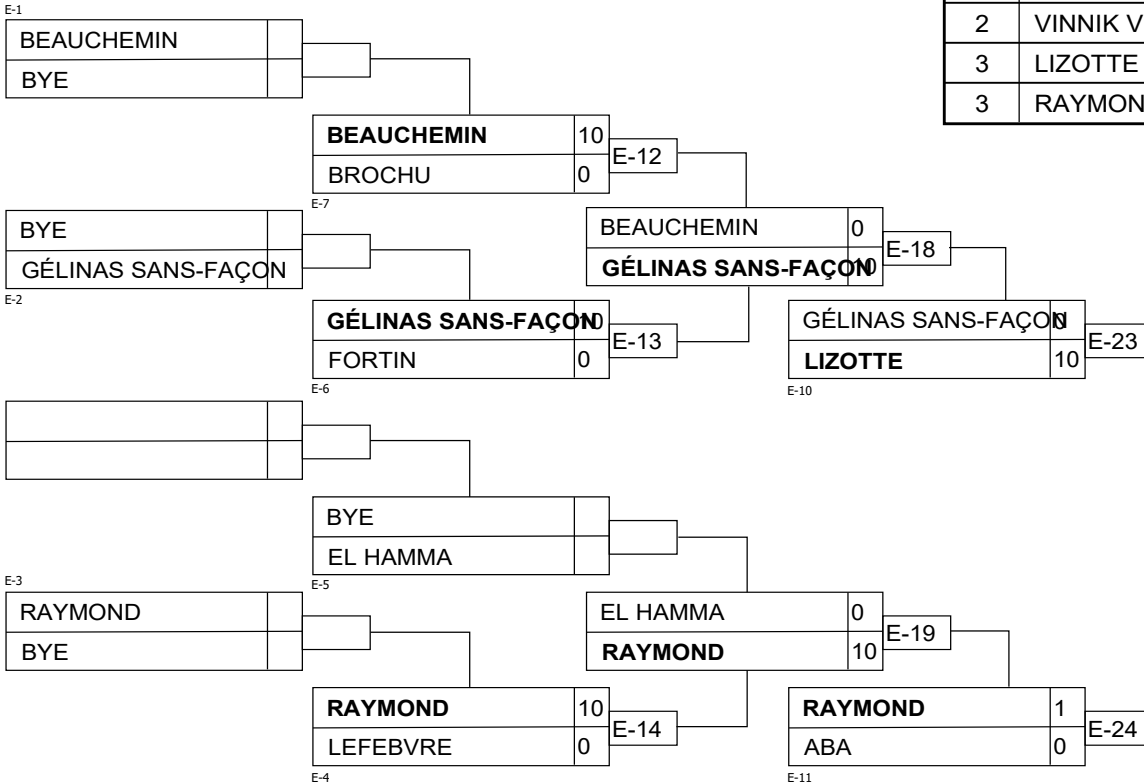



# U14M -42V+

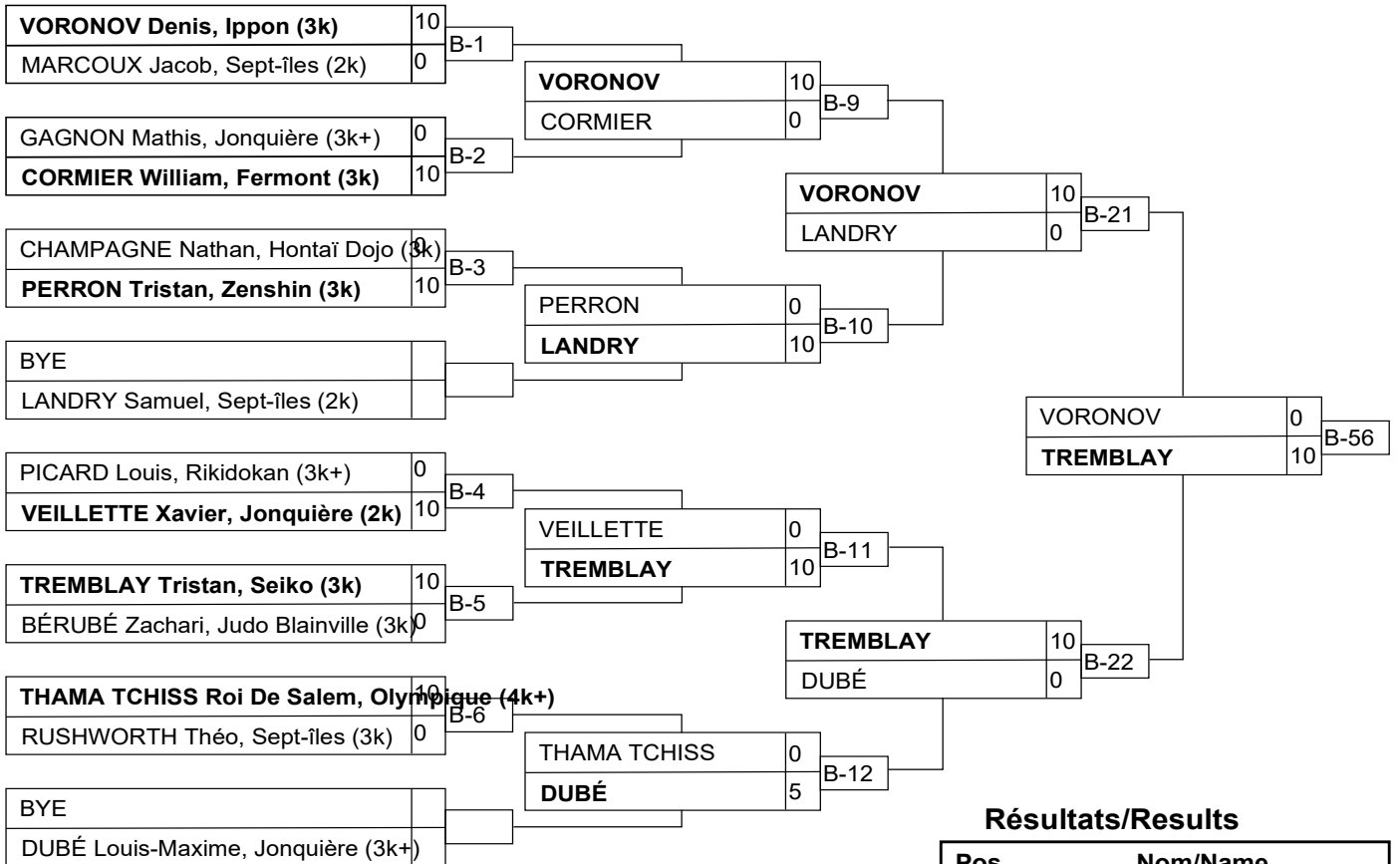

## Résultats/Results

Pos	Nom/Name
1	TREMBLAY Tristan, Seiko (3k)
2	VORONOV Denis, Ippon (3k)
3	VEILLETTE Xavier, Jonquière (2k)
3	DUBÉ Louis-Maxime, Jonquière (3k+)

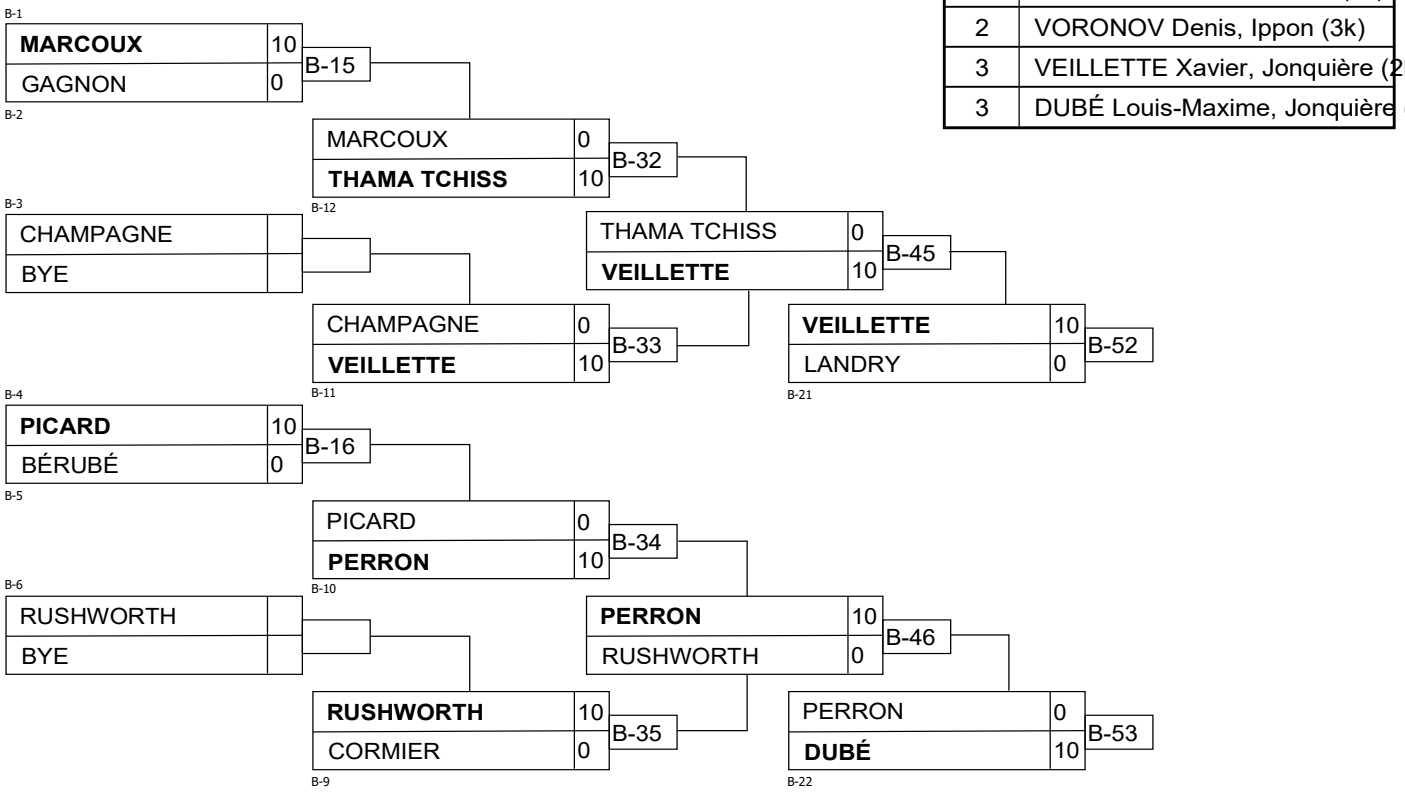

# U14M -46JO

## Compétiteurs/Competitors A

#	Nom/Name	Grade	Club	1	2	3	G/W	Pts	Pos
1	BOISJOLY Adam	5k+	Kime-Waza	XX	10		1	10	2
2	LAGACÉ Raphael	4k+	St-Paul l'Ermite		XX	1	1	1	3
3	ALAOUI YAZIDI Adam	4k+	Budokan Saint-Laurent	10		XX	1	10	1

## Matches/Matches A

Match	Blanc/White	Bleu/Blue	Rés/Res	Tmp/Tim	Code
D-11	BOISJOLY Adam	1 2 LAGACÉ Raphael	10 - 0	0:49	IPO
D-23	BOISJOLY Adam	1 3 ALAOUI YAZIDI Adam	0 - 10	0:06	IPO
D-33	LAGACÉ Raphael	2 3 ALAOUI YAZIDI Adam	1 - 0	3:00	YUS

## Compétiteurs/Competitors B

#	Nom/Name	Grade	Club	4	5	6	G/W	Pts	Pos
4	DESGAGNÉ Dylan	5k	Jonquière	XX			0	0	3
5	FITHANE Fahd	4k	Shidokan	10	XX	10	2	20	1
6	KONÉ Rayanne	5k+	Chicoutimi	10		XX	1	10	2

## Matches/Matches B

Match	Blanc/White	Bleu/Blue	Rés/Res	Tmp/Tim	Code
D-12	DESGAGNÉ Dylan	4 5 FITHANE Fahd	0 - 10	0:08	IPO
D-24	DESGAGNÉ Dylan	4 6 KONÉ Rayanne	0 - 10	0:09	IPO
D-34	FITHANE Fahd	5 6 KONÉ Rayanne	10 - 0	0:21	WIP

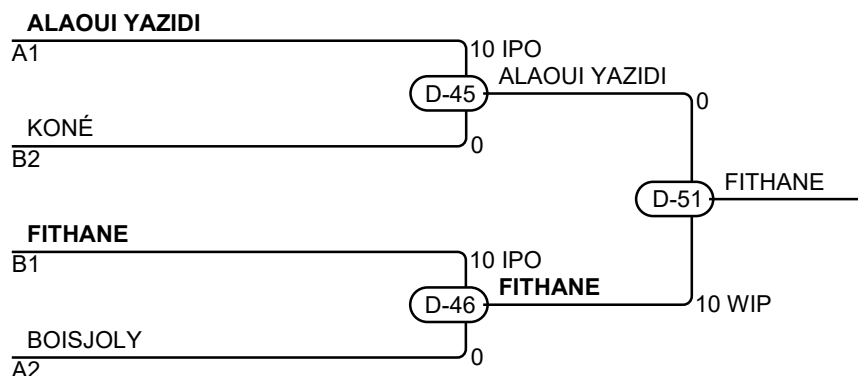

## Résultats/Results

Pos	Nom/Name
1	FITHANE Fahd, Shidokan
2	ALAOUI YAZIDI Adam, Budokan Saint-Laurent
3	KONÉ Rayanne, Chicoutimi
3	BOISJOLY Adam, Kime-Waza

# U14M -46V+

## Compétiteurs/Competitors

#	Nom/Name	Grade	Club	1	2	3	4	5	G/W	Pts	Pos
1	MARTEL anthony	2k	To Hakukan	XX	10	10	10	10	4	40	1
2	SIMARD Nathaniel	2k	Port Cartier		XX			10	1	10	4
3	ARSENAULT Nicolas	2k	Sept-îles		10	XX	10	10	3	30	2
4	MORIN Léopol	3k	Seiko		10		XX	10	2	20	3
5	SIMARD Léo	3k	Judo-Tech					XX	0	0	5

## Matches/Matches

Match	Blanc/White			Bleu/Blue	Rés/Res	Tmp/Tim	Code
B-7	<b>MORIN Léopol</b>	4	5	SIMARD Léo	10 - 0	0:21	WIP
B-8	<b>MARTEL anthony</b>	1	2	SIMARD Nathaniel	10 - 0	0:14	IPO
B-13	<b>ARSENAULT Nicolas</b>	3	4	MORIN Léopol	10 - 0	0:38	IPO
B-14	<b>MARTEL anthony</b>	1	5	SIMARD Léo	10 - 0	0:08	IPO
B-17	SIMARD Nathaniel	2	3	<b>ARSENAULT Nicolas</b>	0 - 10	0:25	IPO
B-18	<b>MARTEL anthony</b>	1	4	MORIN Léopol	10 - 0	0:01	IPO
B-28	<b>ARSENAULT Nicolas</b>	3	5	SIMARD Léo	10 - 0	0:12	IPO
B-29	SIMARD Nathaniel	2	4	<b>MORIN Léopol</b>	0 - 10	0:32	WIP
B-41	<b>MARTEL anthony</b>	1	3	ARSENAULT Nicolas	10 - 0	0:28	IPO
B-42	<b>SIMARD Nathaniel</b>	2	5	SIMARD Léo	10 - 0	0:01	FUS

## Résultats/Results

Pos	Nom/Name
1	MARTEL anthony, To Hakukan
2	ARSENAULT Nicolas, Sept-îles
3	MORIN Léopol, Seiko
4	SIMARD Nathaniel, Port Cartier

# U14M -50JO

## Compétiteurs/Competitors

#	Nom/Name	Grade	Club	1	2	3	4	G/W	Pts	Pos
1	GAGNÉ Jason	4k	St-Georges	XX		10		1	10	3
2	KONÉ Meyrouanne	5k+	Chicoutimi	10	XX	10	10	3	30	1
3	ROY Xavier	4k+	Longueuil			XX		0	0	4
4	DOYON Louis	4k+	Donini/Univestrie	10		10	XX	2	20	2

## Matches/Matches

Match	Blanc/White			Bleu/Blue	Rés/Res	Tmp/Tim	Code
C-19	GAGNÉ Jason	1	2	KONÉ Meyrouanne	0 - 10	0:48	WIP
C-20	ROY Xavier	3	4	DOYON Louis	0 - 10	0:22	WIP
C-28	<b>GAGNÉ Jason</b>	1	3	ROY Xavier	10 - 0	1:42	HAN
C-29	<b>KONÉ Meyrouanne</b>	2	4	DOYON Louis	10 - 0	0:46	IPO
C-37	GAGNÉ Jason	1	4	<b>DOYON Louis</b>	0 - 10	0:07	IPO
C-38	<b>KONÉ Meyrouanne</b>	2	3	ROY Xavier	10 - 0	0:16	IPO

## Résultats/Results

Pos	Nom/Name
1	KONÉ Meyrouanne, Chicoutimi
2	DOYON Louis, Donini/Univestrie
3	GAGNÉ Jason, St-Georges

# U14M -50V+

## Compétiteurs/Competitors A

#	Nom/Name	Grade	Club	1	2	3	G/W	Pts	Pos
1	TERRIEN Jérémie	3k	Albatros	XX	10		1	10	2
2	PROULX-OLSON Skyler	1k	Perrot Shima		XX		0	0	3
3	PHANEUF michael	2k+	To Hakukan	10	10	XX	2	20	1

## Matches/Matches A

Match	Blanc/White			Bleu/Blue	Rés/Res	Tmp/Tim	Code
B-23	TERRIEN Jérémie	1	2	PROULX-OLSON Skyler	10 - 0	0:48	IPO
B-36	TERRIEN Jérémie	1	3	PHANEUF michael	0 - 10	0:41	WIP
B-47	PROULX-OLSON Skyler	2	3	PHANEUF michael	0 - 10	0:19	WIP

## Compétiteurs/Competitors B

#	Nom/Name	Grade	Club	4	5	6	G/W	Pts	Pos
4	BOULIANNE Charles-Etienne	3k	Albatros	XX	10		1	10	2
5	TREMBLAY etienne	3k	To Hakukan		XX		0	0	3
6	QUIEDEVILLE Laurent	2k+	Vieille-Capitale	10	10	XX	2	20	1

## Matches/Matches B

Match	Blanc/White			Bleu/Blue	Rés/Res	Tmp/Tim	Code
B-24	BOULIANNE Charles-Etienne	4	5	TREMBLAY etienne	10 - 0	0:09	IPO
B-37	BOULIANNE Charles-Etienne	4	6	QUIEDEVILLE Laurent	0 - 10	2:56	WIP
B-48	TREMBLAY etienne	5	6	QUIEDEVILLE Laurent	0 - 10	0:01	FUS

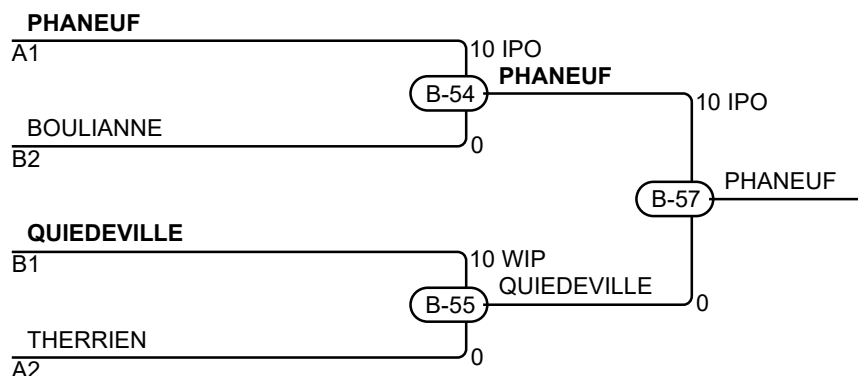

## Résultats/Results

Pos	Nom/Name
1	PHANEUF michael, To Hakukan
2	QUIEDEVILLE Laurent, Vieille-Capitale
3	BOULIANNE Charles-Etienne, Albatros
3	TERRIEN Jérémie, Albatros

# U14M -55JO

## Compétiteurs/Competitors

#	Nom/Name	Grade	Club	1	2	3	G/W	Pts	Pos
1	GAUTHIER Jean Simon	4k+	Ju Shin Kan	XX	10		1	10	2
2	GENDRON Samuel	4k	Baie-Comeau		XX		0	0	3
3	GOLDUR Marius	4k	Judo Ben	10	10	XX	2	20	1

## Matches/Matches

Match	Blanc/White			Bleu/Blue	Rés/Res	Tmp/Tim	Code
D-20	<b>GAUTHIER Jean Simon</b>	1	2	GENDRON Samuel	10 - 0	1:08	WIP
D-30	GAUTHIER Jean Simon	1	3	<b>GOLDUR Marius</b>	0 - 10	0:01	IPO
D-42	GENDRON Samuel	2	3	<b>GOLDUR Marius</b>	0 - 10	0:41	IPO

## Résultats/Results

Pos	Nom/Name
1	GOLDUR Marius, Judo Ben
2	GAUTHIER Jean Simon , Ju Shin Kan

# U14M -55V+

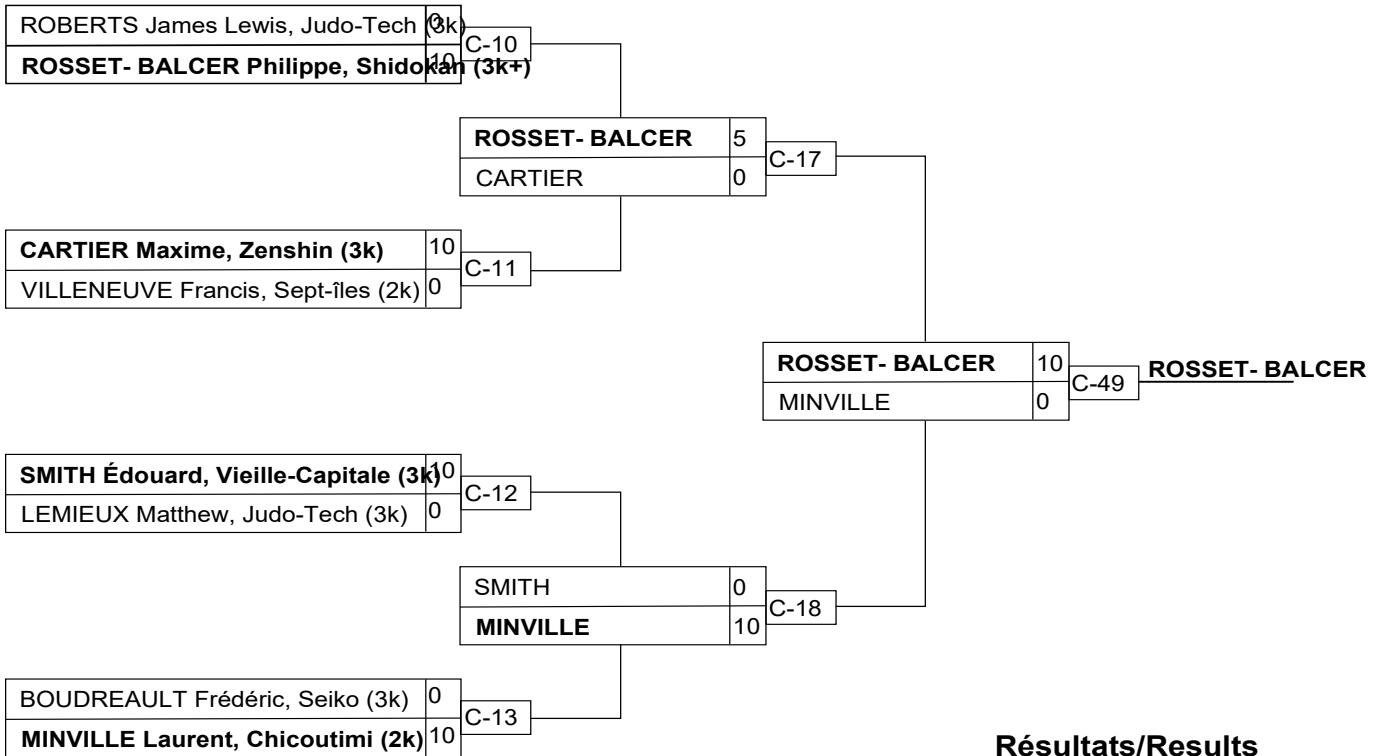

## Résultats/Results

Pos	Nom/Name
1	ROSSET- BALCER Philippe, Shidokan (3k)
2	MINVILLE Laurent, Chicoutimi (2k)
3	CARTIER Maxime, Zenshin (3k)
3	SMITH Édouard, Vieille-Capitale (3k)

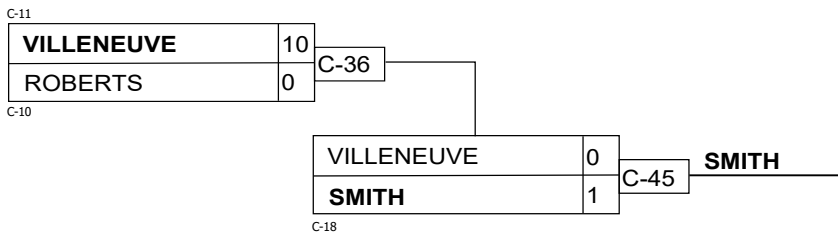
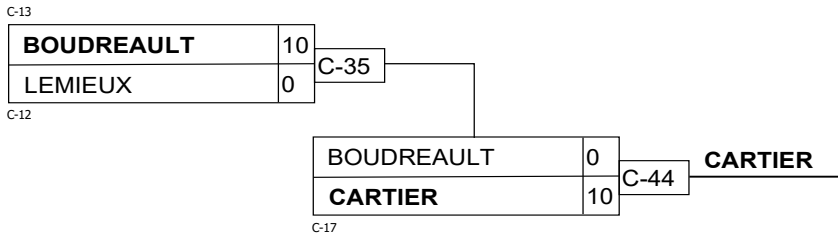

# U14M -60JO

## Compétiteurs/Competitors

#	Nom/Name	Grade	Club	1	2	3	G/W	Pts	Pos
1	OUHAB Arris	4k+	Budokan Saint-Laurent	XX		10	1	10	2
2	BLOUIN Christopher	4k+	Shidokan	10	XX	10	2	20	1
3	LAPORTE Justin	4k	Kime-Waza			XX	0	0	3

## Matches/Matches

Match	Blanc/White			Bleu/Blue	Rés/Res	Tmp/Tim	Code
D-17	OUHAB Arris	1	2	BLOUIN Christopher	0 - 10	0:30	IPO
D-27	OUHAB Arris	1	3	LAPORTE Justin	10 - 0	1:13	WIP
D-39	BLOUIN Christopher	2	3	LAPORTE Justin	10 - 0	0:30	WIP

## Résultats/Results

Pos	Nom/Name
1	BLOUIN Christopher, Shidokan
2	OUHAB Arris, Budokan Saint-Laurent



# U14M -60V+

## Compétiteurs/Competitors

#	Nom/Name	Grade	Club	1	2	3	G/W	Pts	Pos
1	DUHAMEL LOIC-OLIVIER	3k+	CJVR	XX			0	0	3
2	KARPUKOV Arthur	3k	Shidokan	10	XX	10	2	20	1
3	BUREAU Xavier	3k+	Ghishintaïdo	10		XX	1	10	2

## Matches/Matches

Match	Blanc/White			Bleu/Blue	Rés/Res	Tmp/Tim	Code
B-25	DUHAMEL LOIC-OLIVIER	1	2	KARPUKOV Arthur	0 - 10	0:52	IPO
B-38	DUHAMEL LOIC-OLIVIER	1	3	BUREAU Xavier	0 - 10	0:57	IPO
B-49	KARPUKOV Arthur	2	3	BUREAU Xavier	10 - 0	0:09	IPO

## Résultats/Results

Pos	Nom/Name
1	KARPUKOV Arthur, Shidokan
2	BUREAU Xavier, Ghishintaïdo

# U14M -66V+

## Compétiteurs/Competitors

#	Nom/Name	Grade	Club	1	2	3	4	5	G/W	Pts	Pos
1	SAUMURE Henri	3k	Boucherville	XX				10	1	10	4
2	SHAHGALDI Maani	3k	Boucherville	10	XX		1	5	3	16	2
3	NGOMBI Jérémie	3k+	Shidokan	10	10	XX	10	10	4	40	1
4	DURRAND Vincent	2k	CJVR	10			XX	10	2	20	3
5	DURAND Jeremy	2k	CJVR					XX	0	0	5

## Matches/Matches

Match	Blanc/White			Bleu/Blue	Rés/Res	Tmp/Tim	Code
A-9	<b>DURRAND Vincent</b>	4	5	DURAND Jeremy	10 - 0	2:12	WIP
A-10	SAUMURE Henri	1	2	<b>SHAHGALDI Maani</b>	0 - 10	3:00	GSI
A-17	<b>NGOMBI Jérémie</b>	3	4	DURRAND Vincent	10 - 0	3:00	IPO
A-18	<b>SAUMURE Henri</b>	1	5	DURAND Jeremy	10 - 0	2:31	IPO
A-28	SHAHGALDI Maani	2	3	<b>NGOMBI Jérémie</b>	0 - 10	2:13	WIP
A-29	SAUMURE Henri	1	4	<b>DURRAND Vincent</b>	0 - 10	2:58	WIP
A-38	<b>NGOMBI Jérémie</b>	3	5	DURAND Jeremy	10 - 0	0:52	WIP
A-39	<b>SHAHGALDI Maani</b>	2	4	DURRAND Vincent	1 - 0	6:00	YUS
A-50	SAUMURE Henri	1	3	<b>NGOMBI Jérémie</b>	0 - 10	1:07	IPO
A-51	<b>SHAHGALDI Maani</b>	2	5	DURAND Jeremy	5 - 0	3:00	WAZ

## Résultats/Results

Pos	Nom/Name
1	NGOMBI Jérémie, Shidokan
2	SHAHGALDI Maani, Boucherville
3	DURRAND Vincent, CJVR
4	SAUMURE Henri, Boucherville

# U14M +66JO

## Compétiteurs/Competitors

#	Nom/Name	Grade	Club	1	2	3	4	G/W	Pts	Pos
1	MESSÉ A BESSONG John Junior Serge	4k	Judo Ben	XX	5		10	2	15	2
2	LOUAHLA Yanis	4k	Métropolitain		XX		10	1	10	3
3	KANE Jamal	4k	Olympique	10	10	XX	10	3	30	1
4	LANDRY Xavier	4k+	Judo Victo				XX	0	0	4

## Matches/Matches

Match	Blanc/White			Bleu/Blue	Rés/Res	Tmp/Tim	Code
D-21	<b>MESSÉ A BESSONG John Junior Serge</b>	1	2	LOUAHLA Yanis	5 - 0	3:00	WAZ
D-22	<b>KANE Jamal</b>	3	4	LANDRY Xavier	10 - 0	0:15	IPO
D-31	MESSÉ A BESSONG John Junior Serge	1	3	<b>KANE Jamal</b>	0 - 10	2:56	WIP
D-32	<b>LOUAHLA Yanis</b>	2	4	LANDRY Xavier	10 - 0	0:01	IPO
D-43	<b>MESSÉ A BESSONG John Junior Serge</b>	1	4	LANDRY Xavier	10 - 0	1:29	IPO
D-44	LOUAHLA Yanis	2	3	<b>KANE Jamal</b>	0 - 10	0:17	IPO

## Résultats/Results

Pos	Nom/Name
1	KANE Jamal , Olympique
2	MESSÉ A BESSONG John Junior Serge, Judo Ben
3	LOUAHLA Yanis, Métropolitain

# U14M +66V+

## Compétiteurs/Competitors

#	Nom/Name	Grade	Club	1	2	3	4	G/W	Pts	Pos
1	MARCOUILLER Jordan	3k	Shawinigan	XX	10	10		2	20	2
2	POWER William	2k	Fermont		XX	10		1	10	3
3	LEFEBVRE Justin	3k	Asbestos			XX		0	0	4
4	PAKU Elom	3k	Perrot Shima	10	10	10	XX	3	30	1

## Matches/Matches

Match	Blanc/White			Bleu/Blue	Rés/Res	Tmp/Tim	Code
B-26	MARCOUILLER Jordan	1	2	POWER William	10 - 0	0:46	IPO
B-27	LEFEBVRE Justin	3	4	PAKU Elom	0 - 10	1:34	WIP
B-39	MARCOUILLER Jordan	1	3	LEFEBVRE Justin	10 - 0	1:25	IPO
B-40	POWER William	2	4	PAKU Elom	0 - 10	0:44	IPO
B-50	MARCOUILLER Jordan	1	4	PAKU Elom	0 - 10	0:05	IPO
B-51	POWER William	2	3	LEFEBVRE Justin	10 - 0	1:47	WIP

## Résultats/Results

Pos	Nom/Name
1	PAKU Elom, Perrot Shima
2	MARCOUILLER Jordan, Shawinigan
3	POWER William, Fermont

# U16F -40V+

## Compétiteurs/Competitors

#	Nom/Name	Grade	Club	1	G/W	Pts	Pos
1	LAPOINTE Sophie	2k	Port Cartier	XX	0	0	1

## Matches/Matches

Match	Blanc/White	Bleu/Blue	Rés/Res	Tmp/Tim	Code
-------	-------------	-----------	---------	---------	------

## Résultats/Results

Pos	Nom/Name

# U16F -44V+

## Compétiteurs/Competitors

#	Nom/Name	Grade	Club	1	2	1	2	1	2	G/W	Pts	Pos
1	FOREST lana	1k	Beauport	XX	10	XX	10	XX		2	20	1
2	LAPOINTE Sophie	2k	Port Cartier		XX		XX		XX	0	0	2

## Matches/Matches

Match	Blanc/White			Bleu/Blue	Rés/Res	Tmp/Tim	Code
E-28	<b>FOREST lana</b>	1	2	LAPOINTE Sophie	10 - 0	1:31	IPO
E-45	LAPOINTE Sophie	2	1	<b>FOREST lana</b>	0 - 10	1:15	IPO
E-58	FOREST lana	1	2	LAPOINTE Sophie			

## Résultats/Results

Pos	Nom/Name
1	FOREST lana, Beauport

# U16F -48JO

## Compétiteurs/Competitors

#	Nom/Name	Grade	Club	1	2	1	2	1	2	G/W	Pts	Pos
1	DESROCHES Rose-Hélène	4k	Kime-Waza	XX	10	XX	10	XX		2	20	1
2	LARUE Leslie	5k	Amqui		XX		XX		XX	0	0	2

## Matches/Matches

Match	Blanc/White			Bleu/Blue	Rés/Res	Tmp/Tim	Code
E-27	<b>DESROCHES Rose-Hélène</b>	1	2	LARUE Leslie	10 - 0	1:22	WIP
E-44	LARUE Leslie	2	1	<b>DESROCHES Rose-Hélène</b>	0 - 10	0:53	IPO
E-57	DESROCHES Rose-Hélène	1	2	LARUE Leslie			

## Résultats/Results

Pos	Nom/Name
1	DESROCHES Rose-Hélène, Kime-Waza

# U16F -48V+

## Compétiteurs/Competitors

#	Nom/Name	Grade	Club	1	2	3	4	G/W	Pts	Pos
1	MANAILA Rebeca	2k	Shidokan	XX	10	10	10	3	30	1
2	JOBIN Léa	3k	Ju Shin Kan		XX	10	10	2	20	2
3	TURCOTTE Béatrice	2k	Varenes			XX	5	1	5	3
4	SIMARD-LEJEUNE Mathilde	3k	Seiko				XX	0	0	4

## Matches/Matches

Match	Blanc/White			Bleu/Blue	Rés/Res	Tmp/Tim	Code
C-31	MANAILA Rebeca	1	2	JOBIN Léa	10 - 0	1:20	IPO
C-32	TURCOTTE Béatrice	3	4	SIMARD-LEJEUNE Mathilde	5 - 0	6:23	GSW
C-37	MANAILA Rebeca	1	3	TURCOTTE Béatrice	10 - 0	2:12	WIP
C-38	JOBIN Léa	2	4	SIMARD-LEJEUNE Mathilde	10 - 0	1:10	IPO
C-47	MANAILA Rebeca	1	4	SIMARD-LEJEUNE Mathilde	10 - 0	1:03	WIP
C-48	JOBIN Léa	2	3	TURCOTTE Béatrice	10 - 0	1:16	WIP

## Résultats/Results

Pos	Nom/Name
1	MANAILA Rebeca, Shidokan
2	JOBIN Léa, Ju Shin Kan
3	TURCOTTE Béatrice, Varenes



# U16F -52V+

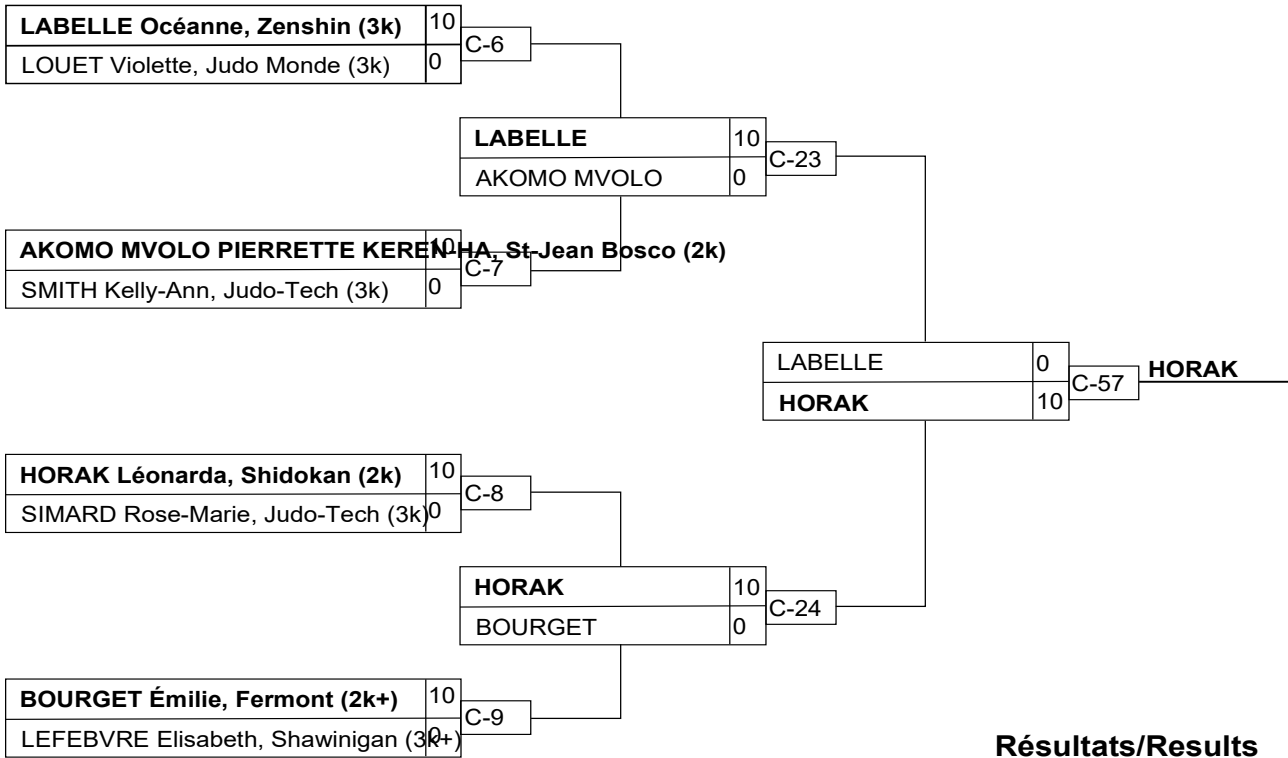

## Résultats/Results

Pos	Nom/Name
1	HORAK Léonarda, Shidokan (2k)
2	LABELLE Océanne, Zenshin (3k)
3	AKOMO MVOLO PIERRETTE KEREN-HA, St-Jean Bosco (2k)
3	BOURGET Émilie, Fermont (2k+)

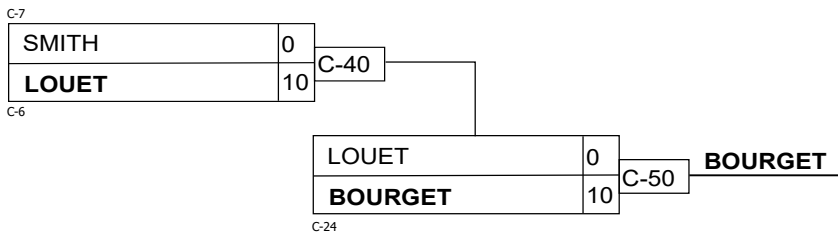
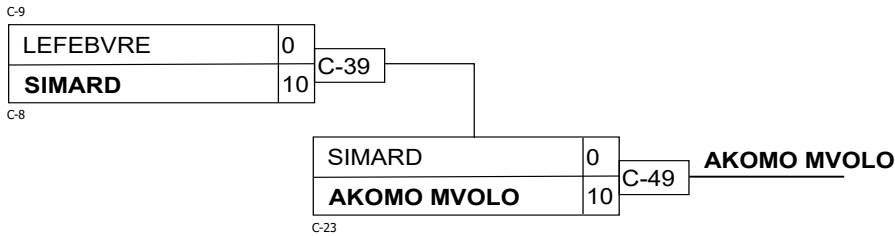

# U16F -57JO

## Compétiteurs/Competitors

#	Nom/Name	Grade	Club	1	2	1	2	1	2	G/W	Pts	Pos
1	BACHEIKH Douaa	4k	Judo Ben	XX	10	XX	10	XX		2	20	1
2	MORIN Frédérique	5k+	Kime-Waza		XX		XX		XX	0	0	2

## Matches/Matches

Match	Blanc/White			Bleu/Blue	Rés/Res	Tmp/Tim	Code
E-21	<b>BACHEIKH Douaa</b>	1	2	MORIN Frédérique	10 - 0	0:04	IPO
E-36	MORIN Frédérique	2	1	<b>BACHEIKH Douaa</b>	0 - 10	1:17	IPO
E-51	BACHEIKH Douaa	1	2	MORIN Frédérique			

## Résultats/Results

Pos	Nom/Name
1	BACHEIKH Douaa , Judo Ben

# U16F -57V+

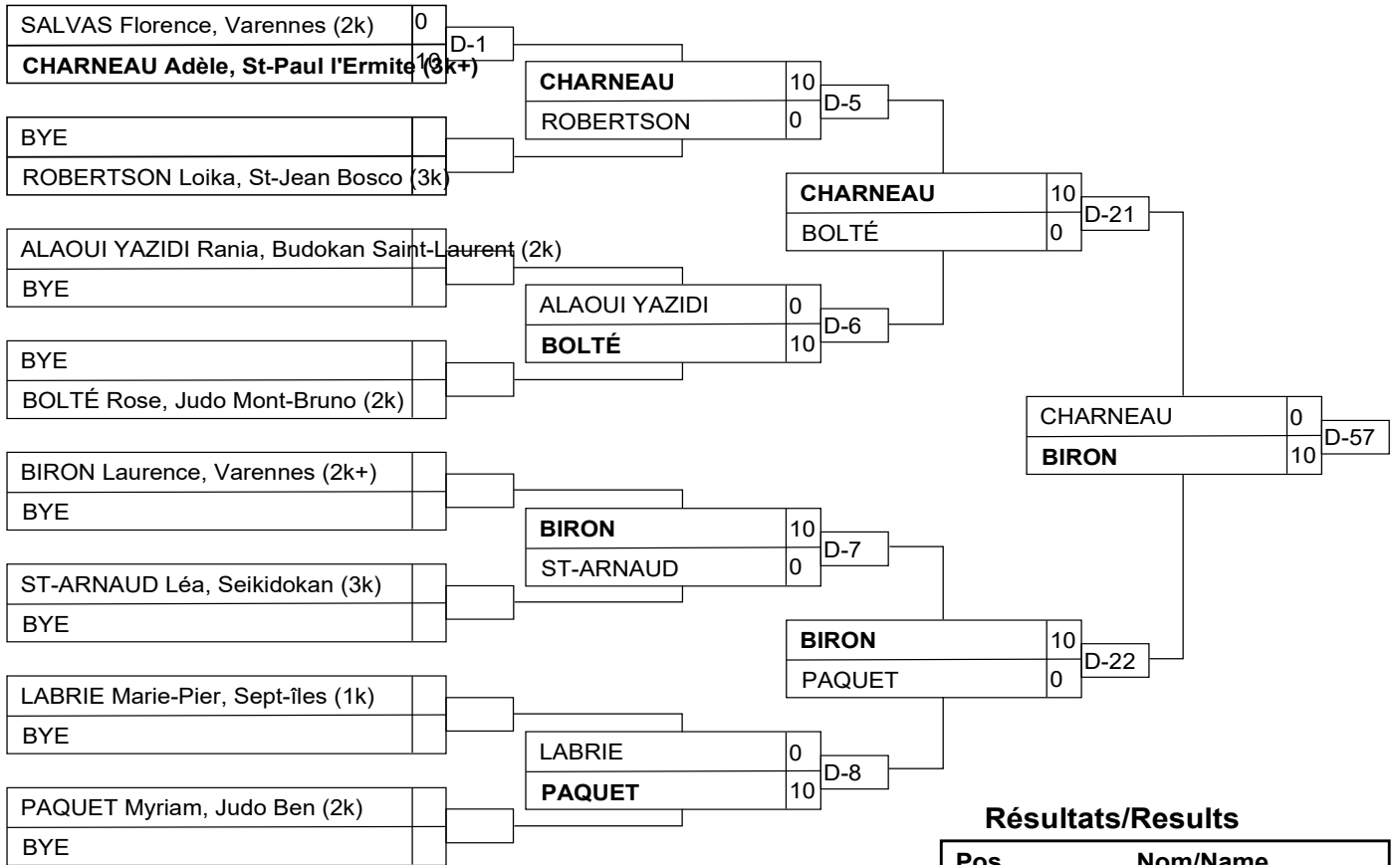

## Résultats/Results

Pos	Nom/Name
1	BIRON Laurence, Varennes (2k+)
2	CHARNEAU Adèle, St-Paul l'Ermite (3k+)
3	SALVAS Florence, Varennes (2k)
3	PAQUET Myriam, Judo Ben (2k)

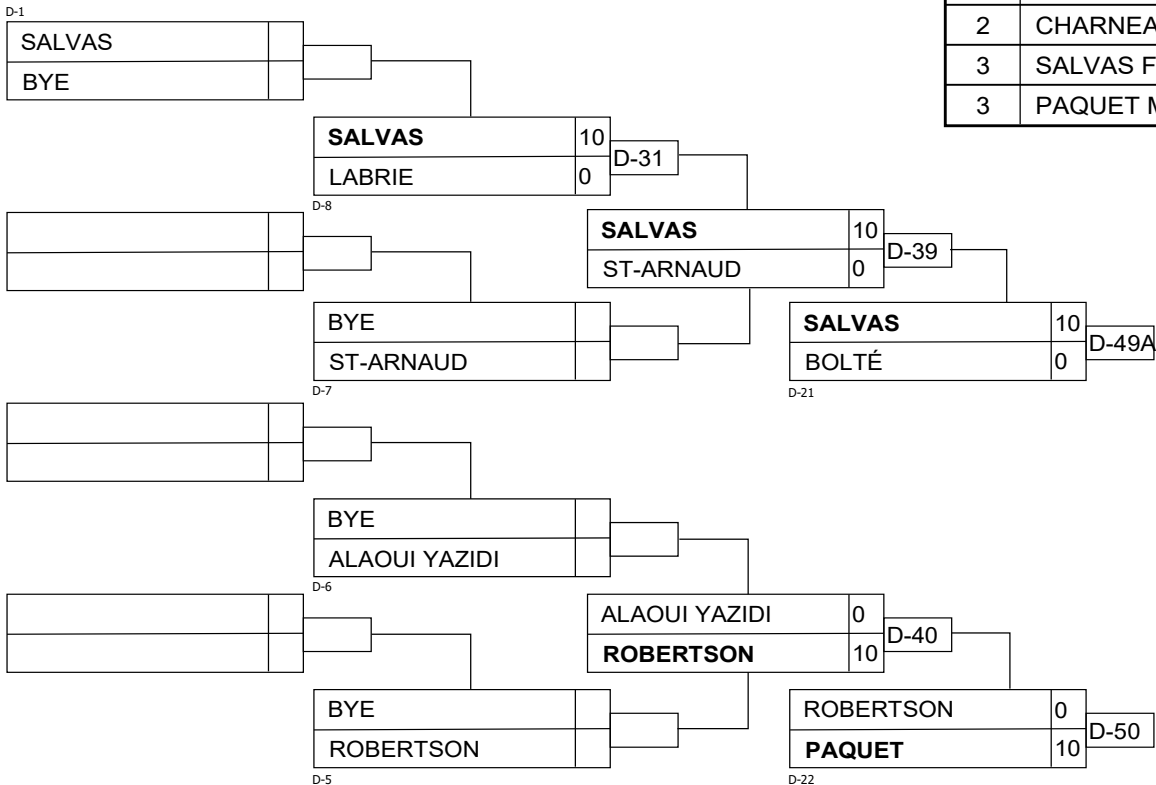

# U16F -63JO

## Compétiteurs/Competitors

#	Nom/Name	Grade	Club	1	2	3	G/W	Pts	Pos
1	MASSICOTTE Élodie	5k	Seikidokan	XX	10	10	2	20	1
2	SARR Oumy	4k	Judo Ben		XX	10	1	10	2
3	LANDRY Sarah	5k	Donini/Univestrie			XX	0	0	3

## Matches/Matches

Match	Blanc/White			Bleu/Blue	Rés/Res	Tmp/Tim	Code
E-30	MASSICOTTE Élodie	1	2	SARR Oumy	10 - 0	1:38	WIP
E-47	MASSICOTTE Élodie	1	3	LANDRY Sarah	10 - 0	1:29	IPO
E-60	SARR Oumy	2	3	LANDRY Sarah	10 - 0	0:48	IPO

## Résultats/Results

Pos	Nom/Name
1	MASSICOTTE Élodie, Seikidokan
2	SARR Oumy, Judo Ben

# U16F -63V+

## Compétiteurs/Competitors

#	Nom/Name	Grade	Club	1	2	3	4	5	G/W	Pts	Pos
1	MANIL Cassandra	2k	Ju Shin Kan	XX	10	10	10	5	4	35	1
2	<del>BRAZEAU Myriam</del>	1k	Perrot Shima		XX	10			1	10	4
3	CORBEIL Julianne	3k+	Baie-Comeau			XX			0	0	5
4	ST-LAURENT miranda	3k+	Torakai		2	10	XX		2	12	3
5	NORMIL lara	1k	Métropolitain		10	10	10	XX	3	30	2

## Matches/Matches

Match	Blanc/White			Bleu/Blue	Rés/Res	Tmp/Tim	Code
D-13	ST-LAURENT miranda	4	5	<b>NORMIL lara</b>	0 - 10	0:22	WIP
D-14	<b>MANIL Cassandra</b>	1	2	BRAZEAU Myriam	10 - 0	0:09	IPO
D-19	CORBEIL Julianne	3	4	<b>ST-LAURENT miranda</b>	0 - 10	0:52	WIP
D-20	<b>MANIL Cassandra</b>	1	5	NORMIL lara	5 - 0	3:00	WAZ
D-27	<b>BRAZEAU Myriam</b>	2	3	CORBEIL Julianne	10 - 0	0:15	IPO
D-28	<b>MANIL Cassandra</b>	1	4	ST-LAURENT miranda	10 - 0	0:37	WIP
D-35	CORBEIL Julianne	3	5	<b>NORMIL lara</b>	0 - 10	0:53	IPO
D-36	BRAZEAU Myriam	2	4	<b>ST-LAURENT miranda</b>	0 - 2	0:05	HAN
D-45	<b>MANIL Cassandra</b>	1	3	CORBEIL Julianne	10 - 0	0:48	WIP
D-46	BRAZEAU Myriam	2	5	<b>NORMIL lara</b>	0 - 10	0:01	FUS

## Résultats/Results

Pos	Nom/Name
1	MANIL Cassandra, Ju Shin Kan
2	NORMIL lara, Métropolitain
3	ST-LAURENT miranda, Torakai
4	<del>BRAZEAU Myriam, Perrot Shima</del>

# U16F -70V+

## Compétiteurs/Competitors

#	Nom/Name	Grade	Club	1	2	1	2	1	2	G/W	Pts	Pos
1	SALLAMI Somaya	2k	Beauport	XX		XX		XX		0	0	2
2	GARNEAU Anne	1k	Lévis	10	XX	10	XX		XX	2	20	1

## Matches/Matches

Match	Blanc/White			Bleu/Blue	Rés/Res	Tmp/Tim	Code
E-25	SALLAMI Somaya	1	2	GARNEAU Anne	0 - 10	2:39	HAN
E-42	GARNEAU Anne	2	1	SALLAMI Somaya	10 - 0	1:51	HAN
E-55	SALLAMI Somaya	1	2	GARNEAU Anne			

## Résultats/Results

Pos	Nom/Name
1	GARNEAU Anne, Lévis

# U16F +70V+

## Compétiteurs/Competitors

#	Nom/Name	Grade	Club	1	2	1	2	1	2	G/W	Pts	Pos
1	LEFEBVRE Élodie	3k+	Asbestos	XX	10	XX	10	XX		2	20	1
2	FOREST Frédérique	3k	Kiseki Judo		XX		XX		XX	0	0	2

## Matches/Matches

Match	Blanc/White			Bleu/Blue	Rés/Res	Tmp/Tim	Code
E-29	LEFEBVRE Élodie	1	2	FOREST Frédérique	10 - 0	1:15	IPO
E-46	FOREST Frédérique	2	1	LEFEBVRE Élodie	0 - 10	0:45	IPO
E-59	LEFEBVRE Élodie	1	2	FOREST Frédérique			

## Résultats/Results

Pos	Nom/Name
1	LEFEBVRE Élodie, Asbestos

# U16M -38V+

## Compétiteurs/Competitors A

#	Nom/Name	Grade	Club	1	2	3	G/W	Pts	Pos
1	GANET matis	2k	Zenshin	XX	10	10	2	20	1
2	GAUDREAU Thomas-Louis	3k	Seiko		XX		0	0	3
3	OUELLET Charles	3k	Shidokan		5	XX	1	5	2

## Matches/Matches A

Match	Blanc/White			Bleu/Blue	Rés/Res	Tmp/Tim	Code
D-29	GANET matis	1	2	GAUDREAU Thomas-Louis	10 - 0	2:11	WIP
D-37	GANET matis	1	3	OUELLET Charles	10 - 0	1:02	WIP
D-47	GAUDREAU Thomas-Louis	2	3	OUELLET Charles	0 - 5	3:00	WAZ

## Compétiteurs/Competitors B

#	Nom/Name	Grade	Club	4	5	6	G/W	Pts	Pos
4	BRÛLÉ Raphaël	2k	Ghishintaïdo	XX	10		1	10	2
5	OUELLET William	3k	Shidokan		XX		0	0	3
6	ROY Victor	2k+	Asbestos	10	10	XX	2	20	1

## Matches/Matches B

Match	Blanc/White			Bleu/Blue	Rés/Res	Tmp/Tim	Code
D-30	BRÛLÉ Raphaël	4	5	OUELLET William	10 - 0	0:15	IPO
D-38	BRÛLÉ Raphaël	4	6	ROY Victor	0 - 10	0:11	IPO
D-48	OUELLET William	5	6	ROY Victor	0 - 10	0:43	IPO

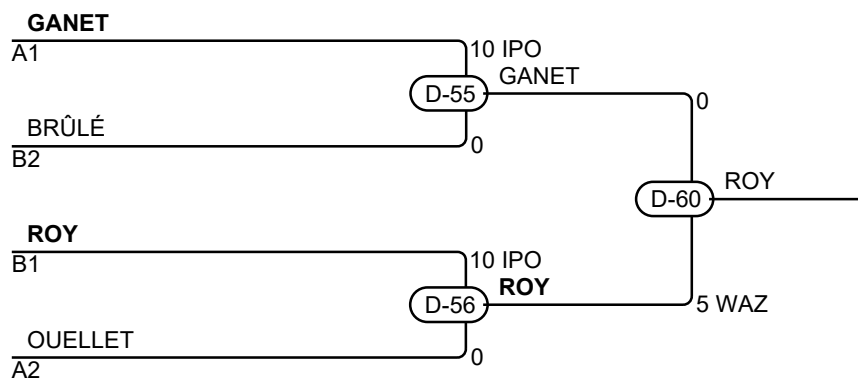

## Résultats/Results

Pos	Nom/Name
1	ROY Victor, Asbestos
2	GANET matis, Zenshin
3	BRÛLÉ Raphaël, Ghishintaïdo
3	OUELLET Charles, Shidokan



# U16M -42V+

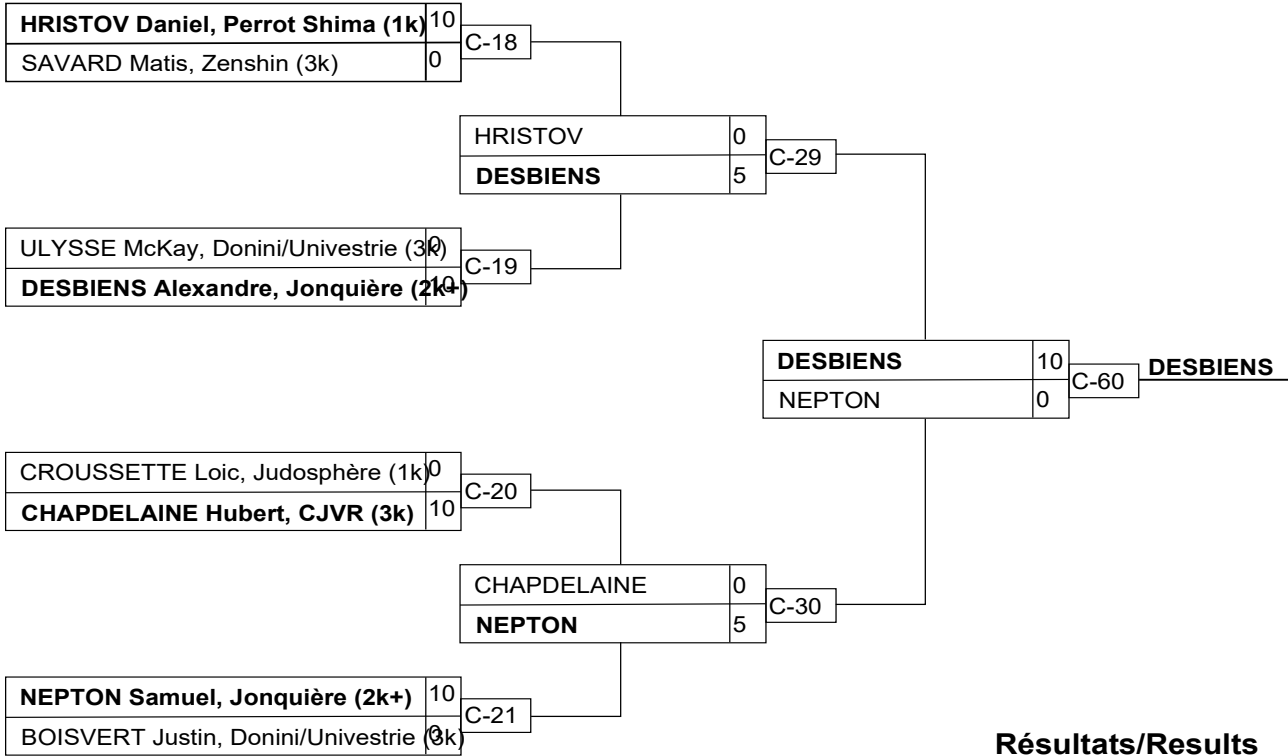

## Résultats/Results

Pos	Nom/Name
1	DESBIENS Alexandre, Jonquière (2k+)
2	NEPTON Samuel, Jonquière (2k+)
3	HRISTOV Daniel, Perrot Shima (1k)
3	ULYSSE McKay, Donini/Univestrie (3k)

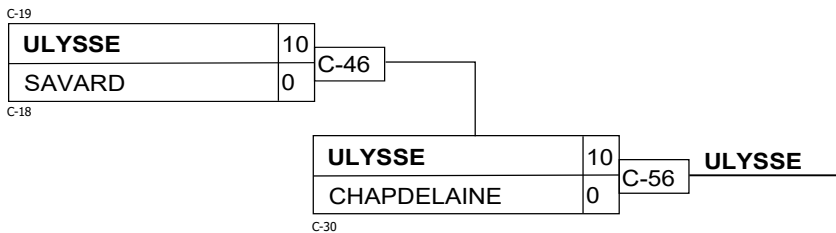
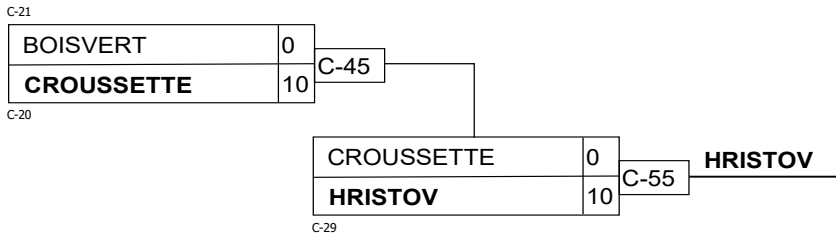

# U16M -46V+

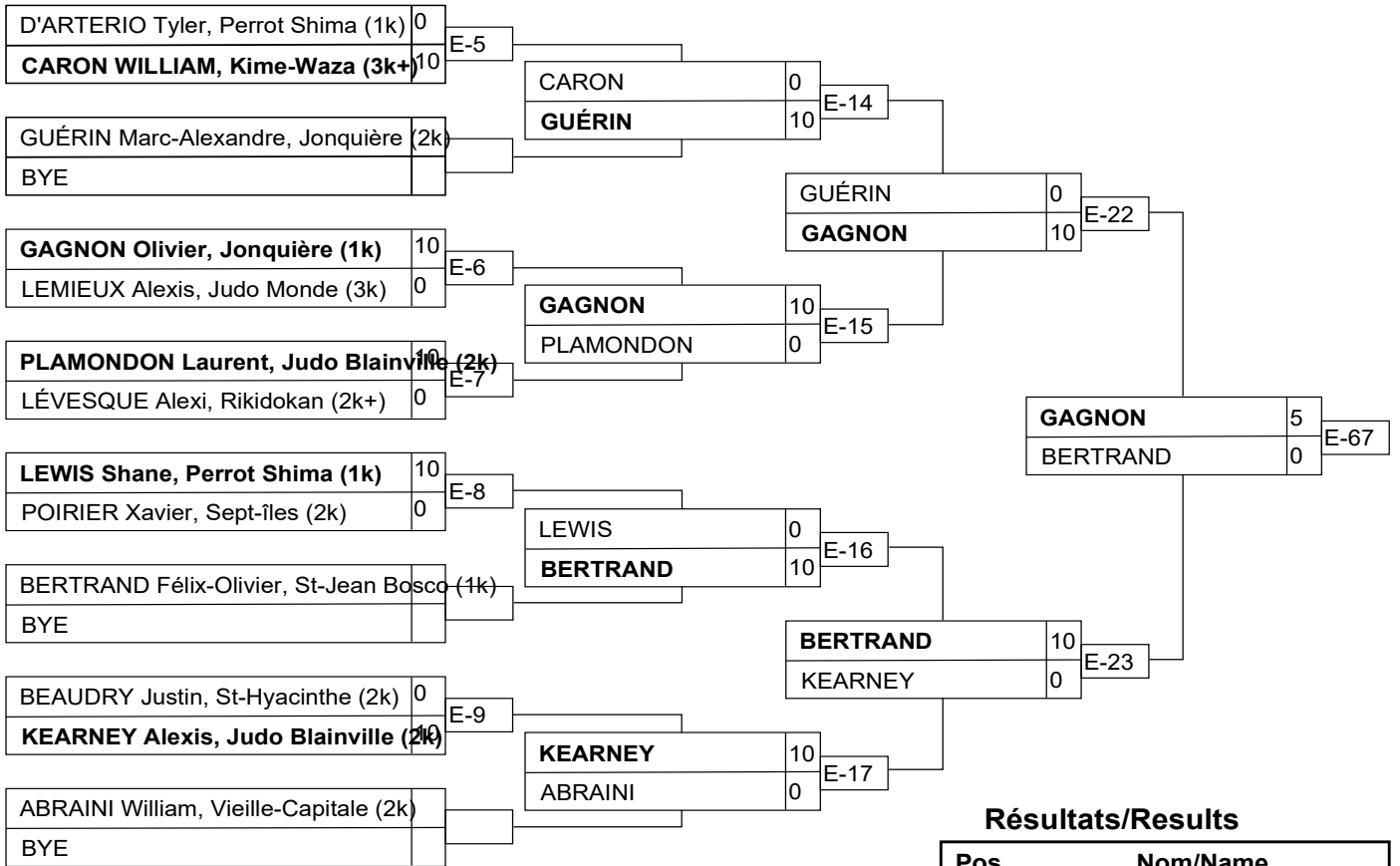

## Résultats/Results

Pos	Nom/Name
1	GAGNON Olivier, Jonquière (1k)
2	BERTRAND Félix-Olivier, St-Jean Bosco (1k)
3	GUÉRIN Marc-Alexandre, Jonquière (2k)
3	POIRIER Xavier, Sept-îles (2k)

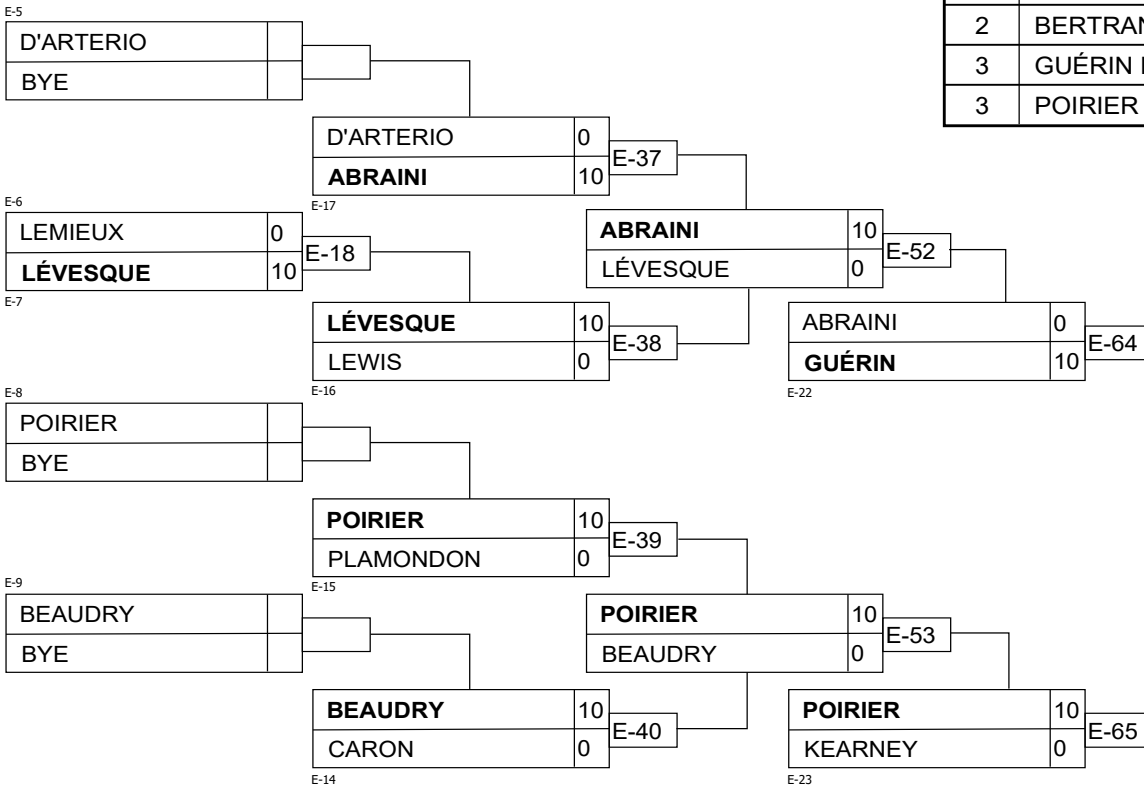

# U16M -50V+

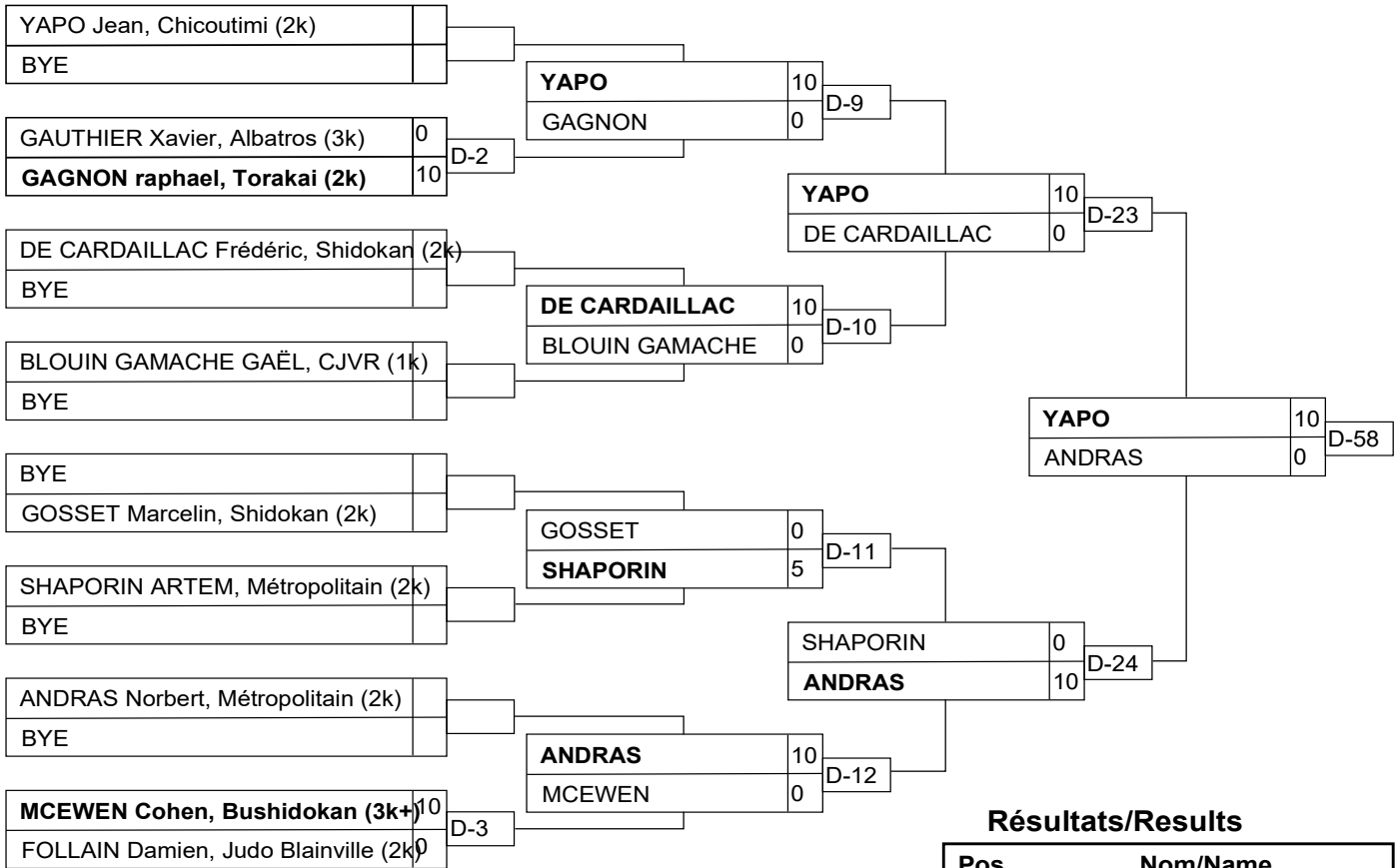

## Résultats/Results

Pos	Nom/Name
1	YAPO Jean, Chicoutimi (2k)
2	ANDRAS Norbert, Métropolitain (2k)
3	DE CARDAILLAC Frédéric, Shidokan (2k)
3	SHAPORIN ARTEM, Métropolitain (2k)

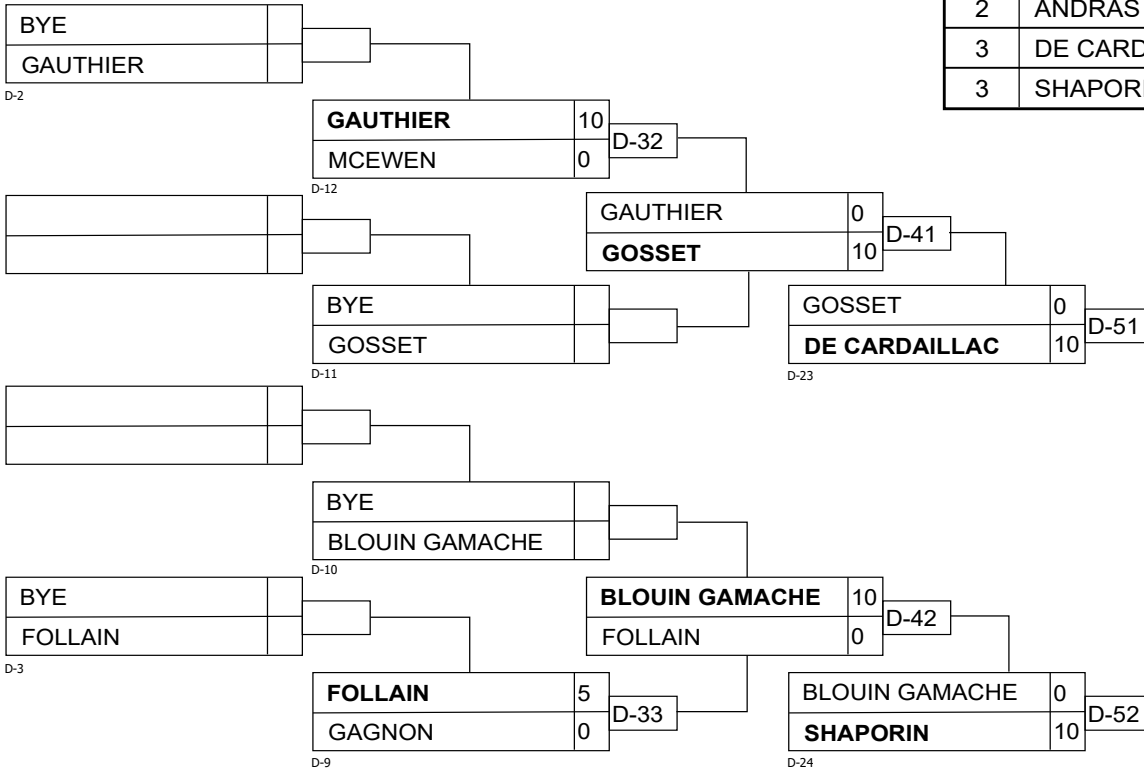

# U16M -55JO

## Compétiteurs/Competitors

#	Nom/Name	Grade	Club	1	2	1	2	1	2	G/W	Pts	Pos
1	LAPORTE William	4k+	Kime-Waza	XX	10	XX	10	XX		2	20	1
2	SIROIS Mathys	4k	Fermont		XX		XX		XX	0	0	2

## Matches/Matches

Match	Blanc/White			Bleu/Blue	Rés/Res	Tmp/Tim	Code
E-24	LAPORTE William	1	2	SIROIS Mathys	10 - 0	0:29	WIP
E-41	SIROIS Mathys	2	1	LAPORTE William	0 - 10	0:10	IPO
E-54	LAPORTE William	1	2	SIROIS Mathys			

## Résultats/Results

Pos	Nom/Name
1	LAPORTE William, Kime-Waza

# U16M -55V+

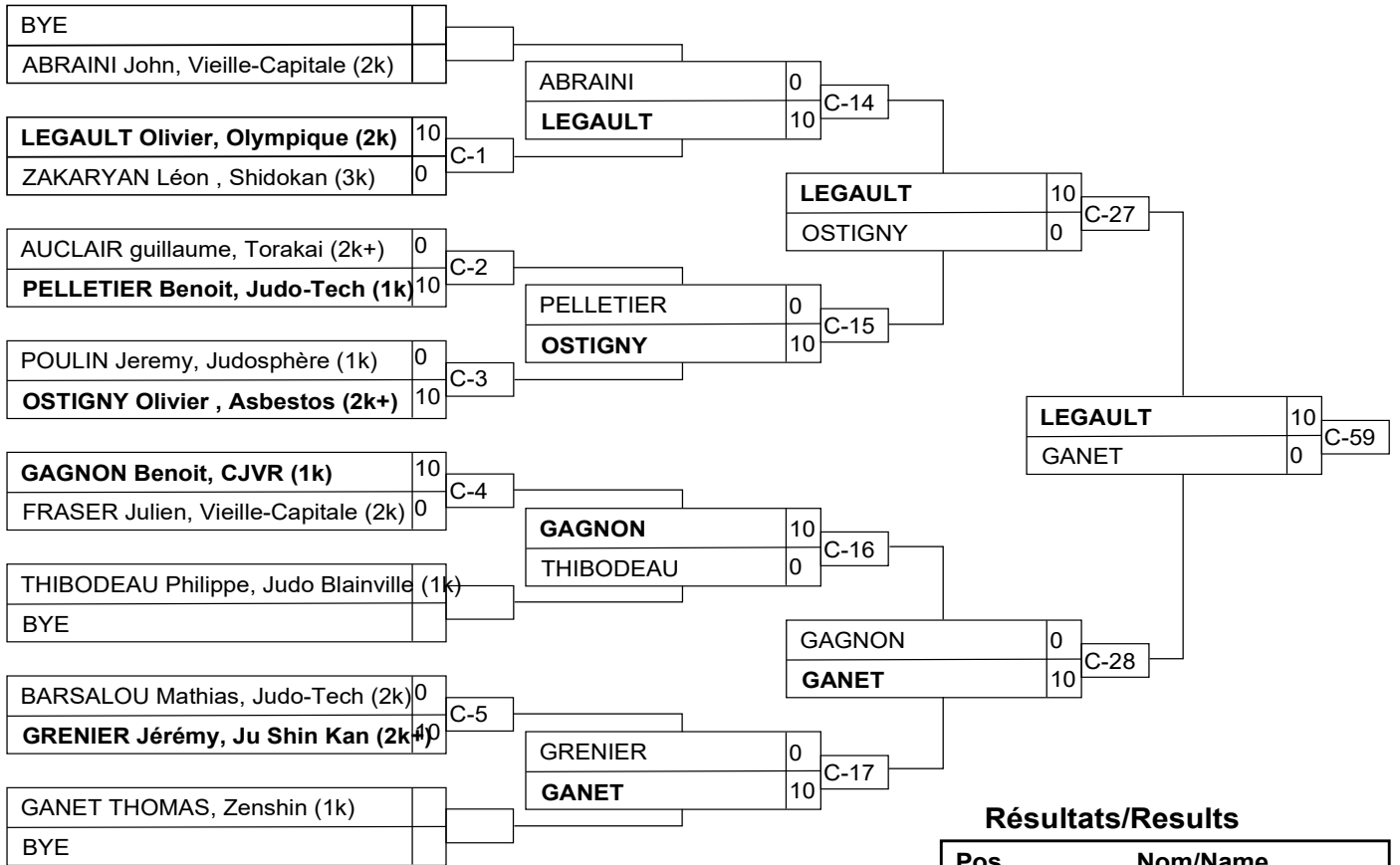

## Résultats/Results

Pos	Nom/Name
1	LEGAULT Olivier, Olympique (2k)
2	GANET THOMAS, Zenshin (1k)
3	THIBODEAU Philippe, Judo Blainville (1k)
3	GAGNON Benoit, CJVR (1k)

# U16M -60JO

## Compétiteurs/Competitors

#	Nom/Name	Grade	Club	1	2	1	2	1	2	G/W	Pts	Pos
1	BÉLANGER Thomas	4k+	Judo Monde	XX	10	XX	5	XX		2	15	1
2	RODRIGUE Anthony	4k	St-Georges		XX		XX		XX	0	0	2

## Matches/Matches

Match	Blanc/White			Bleu/Blue	Rés/Res	Tmp/Tim	Code
E-31	<b>BÉLANGER Thomas</b>	1	2	RODRIGUE Anthony	10 - 0	0:01	IPO
E-48	RODRIGUE Anthony	2	1	<b>BÉLANGER Thomas</b>	0 - 5	3:00	WAZ
E-61	BÉLANGER Thomas	1	2	RODRIGUE Anthony			

## Résultats/Results

Pos	Nom/Name
1	BÉLANGER Thomas, Judo Monde

# U16M -60V+

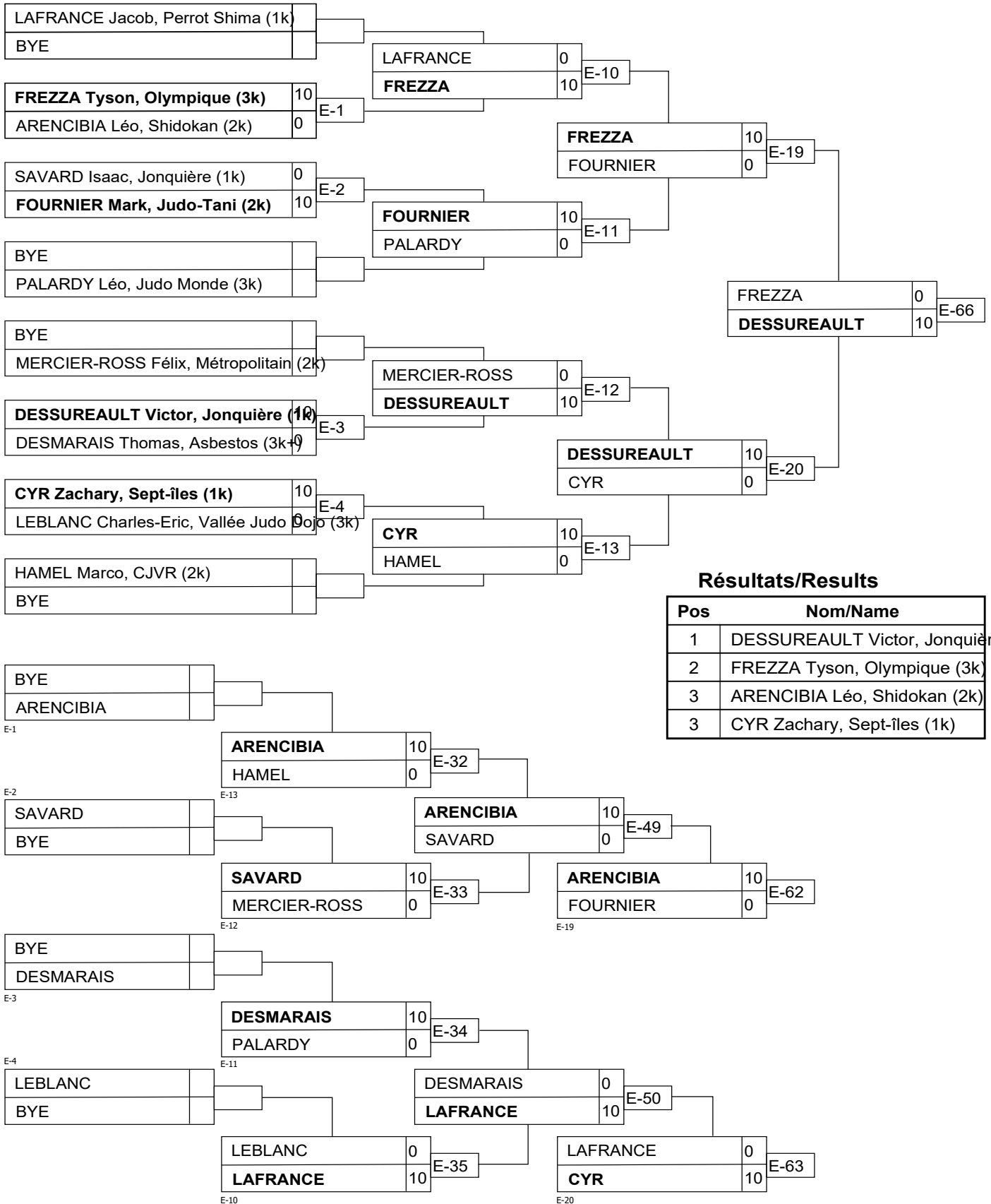

# U16M -66V+

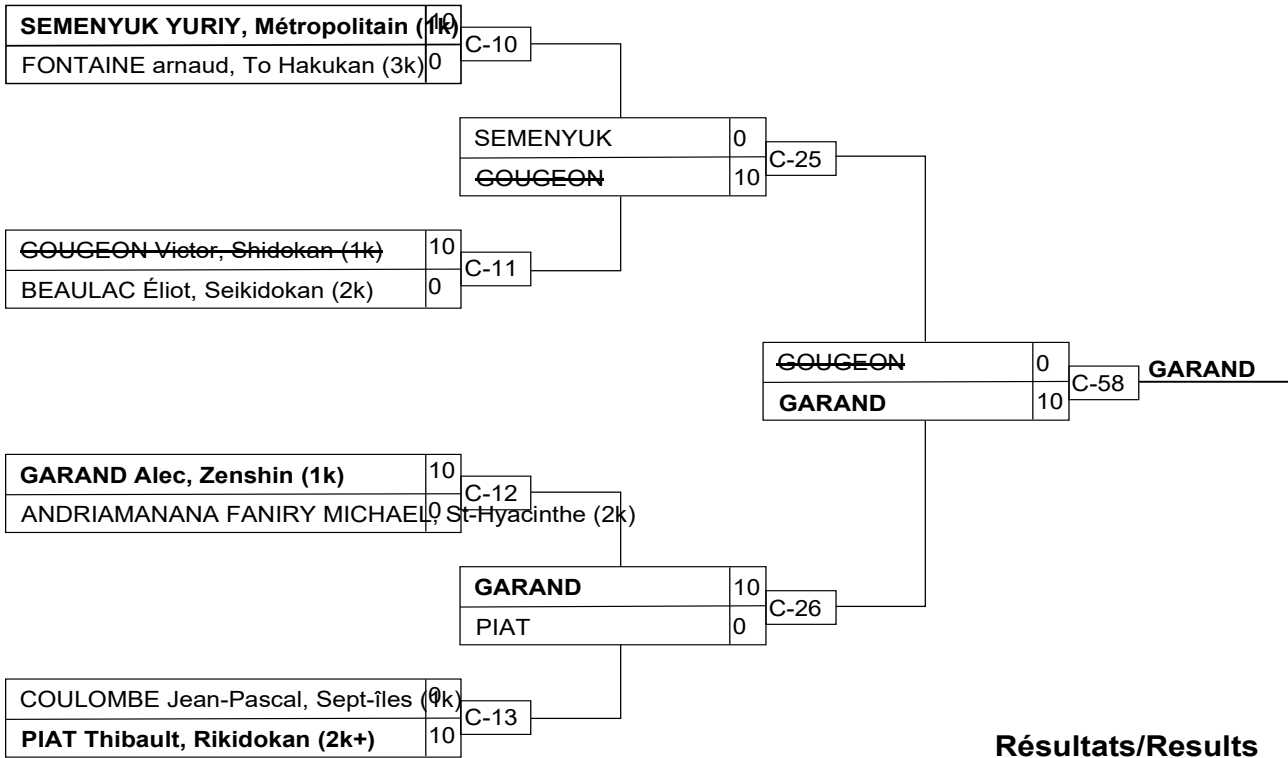

## Résultats/Results

Pos	Nom/Name
1	GARAND Alec, Zenshin (1k)
2	
3	SEMENYUK YURIY, Métropolitain (1k)
3	BEAULAC Éliot, Seikidokan (2k)

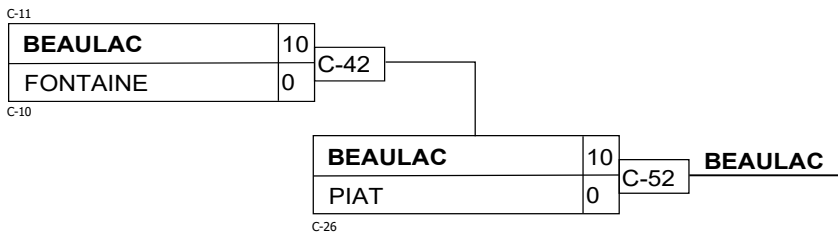
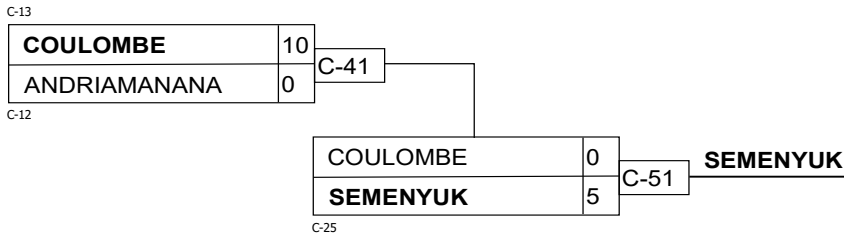



# U16M -73V+

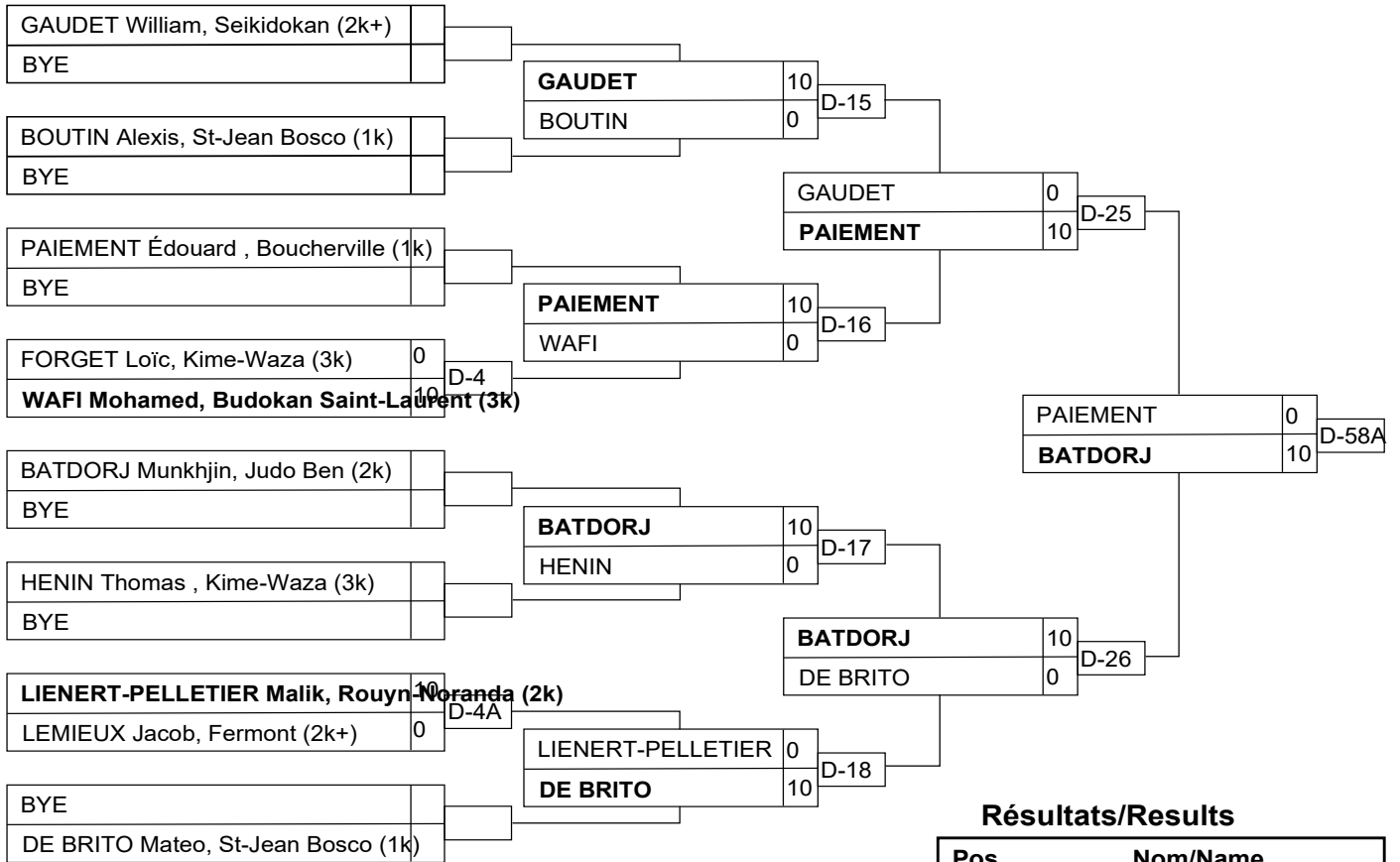

## Résultats/Results

Pos	Nom/Name
1	BATDORJ Munkhjain, Judo Ben (2k)
2	PAIEMENT Édouard, Boucherville (1k)
3	GAUDET William, Seikidokan (2k+)
3	DE BRITO Mateo, St-Jean Bosco (1k)

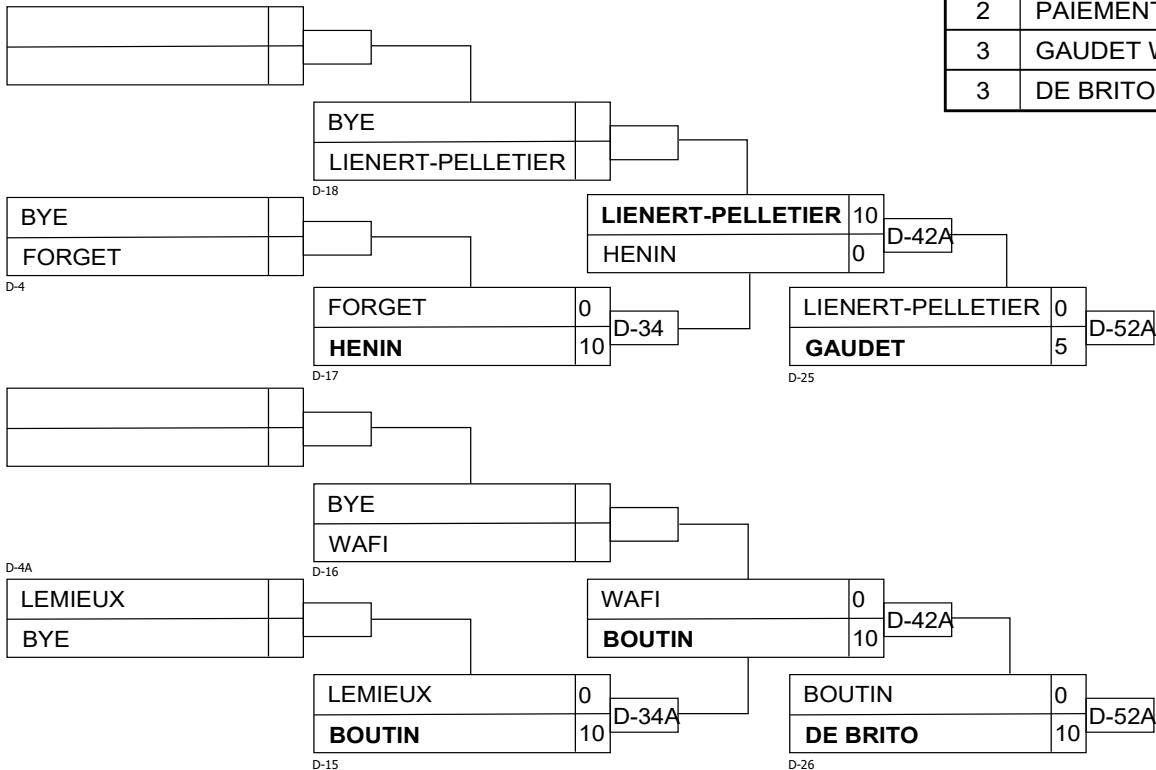

# U16M +73V+

## Compétiteurs/Competitors

#	Nom/Name	Grade	Club	1	2	3	G/W	Pts	Pos
1	HAMEL Alex	2k	CJVR	XX			0	0	3
2	LOUAHLA Elias	2k	Métropolitain	10	XX		1	10	2
3	CÔTÉ Félix	1k	Albatros	10	10	XX	2	20	1

## Matches/Matches

Match	Blanc/White			Bleu/Blue	Rés/Res	Tmp/Tim	Code
E-26	HAMEL Alex	1	2	LOUAHLA Elias	0 - 10	1:57	HAN
E-43	HAMEL Alex	1	3	CÔTÉ Félix	0 - 10	0:29	IPO
E-56	LOUAHLA Elias	2	3	CÔTÉ Félix	0 - 10	1:14	WIP

## Résultats/Results

Pos	Nom/Name
1	CÔTÉ Félix, Albatros
2	LOUAHLA Elias, Métropolitain

# U21/SenB F -48

## Compétiteurs/Competitors

#	Nom/Name	Grade	Club	1	2	3	G/W	Pts	Pos
1	SCREMIN Sabrina	1D	Sept-îles	XX	10		1	10	2
2	MAILHOT-SENEZ Mélodie	1k	Bushidokan		XX		0	0	3
3	ROY Léa	1k	Asbestos	10	10	XX	2	20	1

## Matches/Matches

Match	Blanc/White			Bleu/Blue	Rés/Res	Tmp/Tim	Code
B-19	SCREMIN Sabrina	1	2	MAILHOT-SENEZ Mélodie	10 - 0	2:33	WIP
B-27	SCREMIN Sabrina	1	3	ROY Léa	0 - 10	0:46	IPO
B-37	MAILHOT-SENEZ Mélodie	2	3	ROY Léa	0 - 10	0:42	WIP

## Résultats/Results

Pos	Nom/Name
1	ROY Léa, Asbestos
2	SCREMIN Sabrina, Sept-îles

# U21/SenB F -52

## Compétiteurs/Competitors

#	Nom/Name	Grade	Club	1	G/W	Pts	Pos
1	MALOUM Sarah	1D	Métropolitain	XX	0	0	1

## Matches/Matches

Match	Blanc/White	Bleu/Blue	Rés/Res	Tmp/Tim	Code
-------	-------------	-----------	---------	---------	------

## Résultats/Results

Pos	Nom/Name

# U21/SenB F -57

## Compétiteurs/Competitors

#	Nom/Name	Grade	Club	1	2	3	G/W	Pts	Pos
1	DEGASNE marie garance	1k	To Hakukan	XX			0	0	3
2	RÉGLAT-ARZATE Manon	1D	Hakudokan	10	XX	10	2	20	1
3	DOUHAUD Johanna	1k	Shidokan	10		XX	1	10	2

## Matches/Matches

Match	Blanc/White			Bleu/Blue	Rés/Res	Tmp/Tim	Code
B-15	DEGASNE marie garance	1	2	RÉGLAT-ARZATE Manon	0 - 10	0:46	WIP
B-23	DEGASNE marie garance	1	3	DOUHAUD Johanna	0 - 10	0:45	WIP
B-33	RÉGLAT-ARZATE Manon	2	3	DOUHAUD Johanna	10 - 0	3:16	WIP

## Résultats/Results

Pos	Nom/Name
1	RÉGLAT-ARZATE Manon, Hakudokan
2	DOUHAUD Johanna, Shidokan

# U21/SenB F -63

## Compétiteurs/Competitors A

#	Nom/Name	Grade	Club	1	2	3	G/W	Pts	Pos
1	BOUSSARHANE Samia	1k	Boucherville	XX	10	10	2	20	1
2	EMOND Roxanne	1D	Ju Shin Kan		XX	10	1	10	2
3	AVOMO MVOLO Sherilyne Ketsia	2k	St-Jean Bosco			XX	0	0	3

## Matches/Matches A

Match	Blanc/White			Bleu/Blue	Rés/Res	Tmp/Tim	Code
A-15	BOUSSARHANE Samia	1	2	EMOND Roxanne	10 - 0	1:31	IPO
A-25	BOUSSARHANE Samia	1	3	AVOMO MVOLO Sherilyne Ketsia	10 - 0	0:42	WIP
A-33	EMOND Roxanne	2	3	AVOMO MVOLO Sherilyne Ketsia	10 - 0	0:30	WIP

## Compétiteurs/Competitors B

#	Nom/Name	Grade	Club	4	5	6	G/W	Pts	Pos
4	CAMIRÉ WAN Sophia	2k	Asbestos	XX			0	0	3
5	MARTIN Anne	1D	Seiko	10	XX	10	2	20	1
6	BEIGNET Florianne	3k	Brossard	10		XX	1	10	2

## Matches/Matches B

Match	Blanc/White			Bleu/Blue	Rés/Res	Tmp/Tim	Code
A-16	CAMIRÉ WAN Sophia	4	5	MARTIN Anne	0 - 10	0:16	IPO
A-26	CAMIRÉ WAN Sophia	4	6	BEIGNET Florianne	0 - 10	1:24	IPO
A-34	MARTIN Anne	5	6	BEIGNET Florianne	10 - 0	2:10	IPO

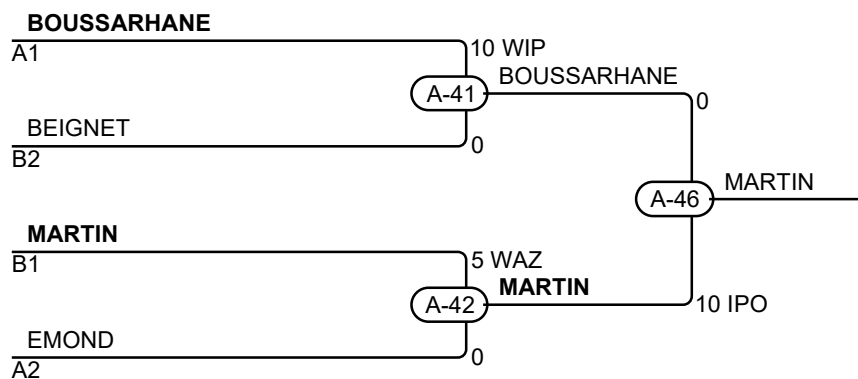

## Résultats/Results

Pos	Nom/Name
1	MARTIN Anne, Seiko
2	BOUSSARHANE Samia, Boucherville
3	BEIGNET Florianne, Brossard
3	EMOND Roxanne, Ju Shin Kan

# U21/SenB F -78

## Compétiteurs/Competitors

#	Nom/Name	Grade	Club	1	2	3	G/W	Pts	Pos
1	LANGLAIS Nancy	1k	Judo-Tech	XX			0	0	3
2	GODBOUT Coralie	1k	Vieille-Capitale	10	XX		1	10	2
3	SYNOTT Josie-Anne	1D	Sept-îles	10	5	XX	2	15	1

## Matches/Matches

Match	Blanc/White			Bleu/Blue	Rés/Res	Tmp/Tim	Code
B-20	LANGLAIS Nancy	1	2	GODBOUT Coralie	0 - 10	0:14	IPO
B-28	LANGLAIS Nancy	1	3	SYNOTT Josie-Anne	0 - 10	0:33	WIP
B-38	GODBOUT Coralie	2	3	SYNOTT Josie-Anne	0 - 5	4:18	GSW

## Résultats/Results

Pos	Nom/Name
1	SYNOTT Josie-Anne, Sept-îles
2	GODBOUT Coralie, Vieille-Capitale

# U21/SenB M -100

## Compétiteurs/Competitors

#	Nom/Name	Grade	Club	1	G/W	Pts	Pos
1	CHOUINARD Yohan	1k	Sept-Iles	XX	0	0	1

## Matches/Matches

Match	Blanc/White	Bleu/Blue	Rés/Res	Tmp/Tim	Code
-------	-------------	-----------	---------	---------	------

## Résultats/Results

Pos	Nom/Name



# U21/SenB M -55

## Compétiteurs/Competitors

#	Nom/Name	Grade	Club	1	2	3	G/W	Pts	Pos
1	BLACQUIÈRE Arno	1k	Jonquièrre	XX	10	10	2	20	1
2	SAURIOL Nathan	1k	Judo Blainville		XX		0	0	3
3	TREMBLAY Justin	1k	Seikidokan		10	XX	1	10	2

## Matches/Matches

Match	Blanc/White			Bleu/Blue	Rés/Res	Tmp/Tim	Code
A-17	BLACQUIÈRE Arno	1	2	SAURIOL Nathan	10 - 0	1:56	WIP
A-27	BLACQUIÈRE Arno	1	3	TREMBLAY Justin	10 - 0	1:36	WIP
A-35	SAURIOL Nathan	2	3	TREMBLAY Justin	0 - 10	3:49	IPO

## Résultats/Results

Pos	Nom/Name
1	BLACQUIÈRE Arno, Jonquièrre
2	TREMBLAY Justin, Seikidokan

# U21/SenB M -60

## Compétiteurs/Competitors A

#	Nom/Name	Grade	Club	1	2	3	4	G/W	Pts	Pos
1	ST-HILAIRE Isaak	1k	Seiko	XX				0	0	4
2	ESCOLAR Thomas	1D	Shidokan	10	XX		10	2	20	2
3	PELLETIER Malcom	1D	Shidokan	10	10	XX	10	3	30	1
4	NUARA Adam	1D	Shidokan	10			XX	1	10	3

## Matches/Matches A

Match	Blanc/White	Bleu/Blue	Rés/Res	Tmp/Tim	Code
B-16	ST-HILAIRE Isaak	1 2 ESCOLAR Thomas	0 - 10	1:39	IPO
B-17	PELLETIER Malcom	3 4 NUARA Adam	10 - 0	2:28	WIP
B-24	ST-HILAIRE Isaak	1 3 PELLETIER Malcom	0 - 10	2:16	WIP
B-25	ESCOLAR Thomas	2 4 NUARA Adam	10 - 0	2:59	HAN
B-34	ST-HILAIRE Isaak	1 4 NUARA Adam	0 - 10	2:19	WIP
B-35	ESCOLAR Thomas	2 3 PELLETIER Malcom	0 - 10	1:49	HAN

## Compétiteurs/Competitors B

#	Nom/Name	Grade	Club	5	6	7	G/W	Pts	Pos
5	HAITAS Hoah	1k	Shidokan	XX			0	0	3
6	PERELMULTOV Kevin	1k	Shidokan	10	XX		1	10	2
7	LANDRY Jacob	1D	Seikidokan	10	10	XX	2	20	1

## Matches/Matches B

Match	Blanc/White	Bleu/Blue	Rés/Res	Tmp/Tim	Code
B-18	HAITAS Hoah	5 6 PERELMULTOV Kevin	0 - 10	0:17	IPO
B-26	HAITAS Hoah	5 7 LANDRY Jacob	0 - 10	0:11	IPO
B-36	PERELMULTOV Kevin	6 7 LANDRY Jacob	0 - 10	0:41	IPO

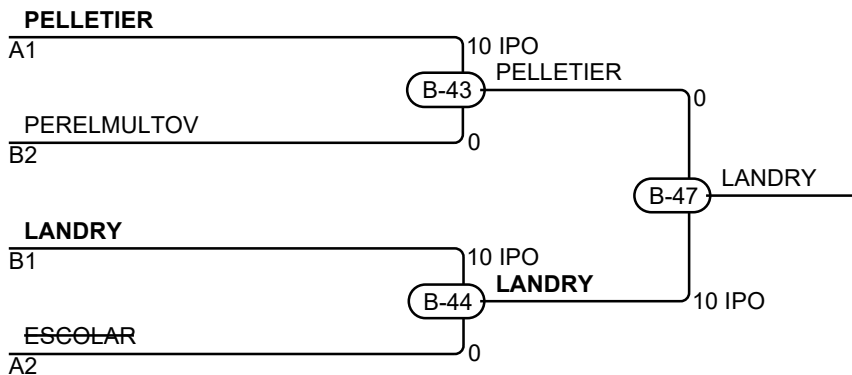

## Résultats/Results

Pos	Nom/Name
1	LANDRY Jacob, Seikidokan
2	PELLETIER Malcom, Shidokan
3	PERELMULTOV Kevin, Shidokan
3	ESCOLAR Thomas, Shidokan

# U21/SenB M -66

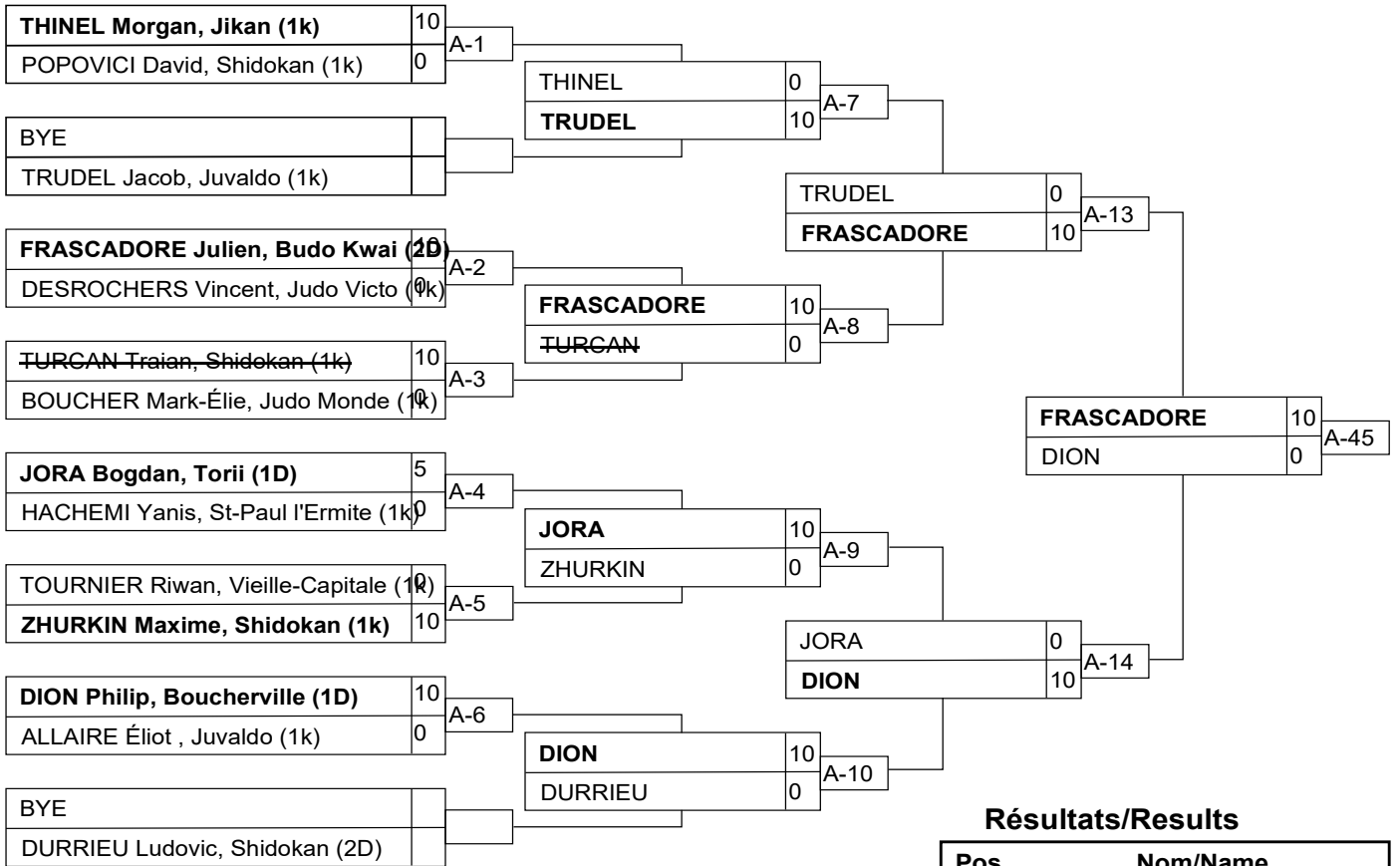

## Résultats/Results

Pos	Nom/Name
1	FRASCADORE Julien, Budo Kwai (2D)
2	DION Philip, Boucherville (1D)
3	DESROCHERS Vincent, Judo Victo (1k)
3	JORA Bogdan, Torii (1D)

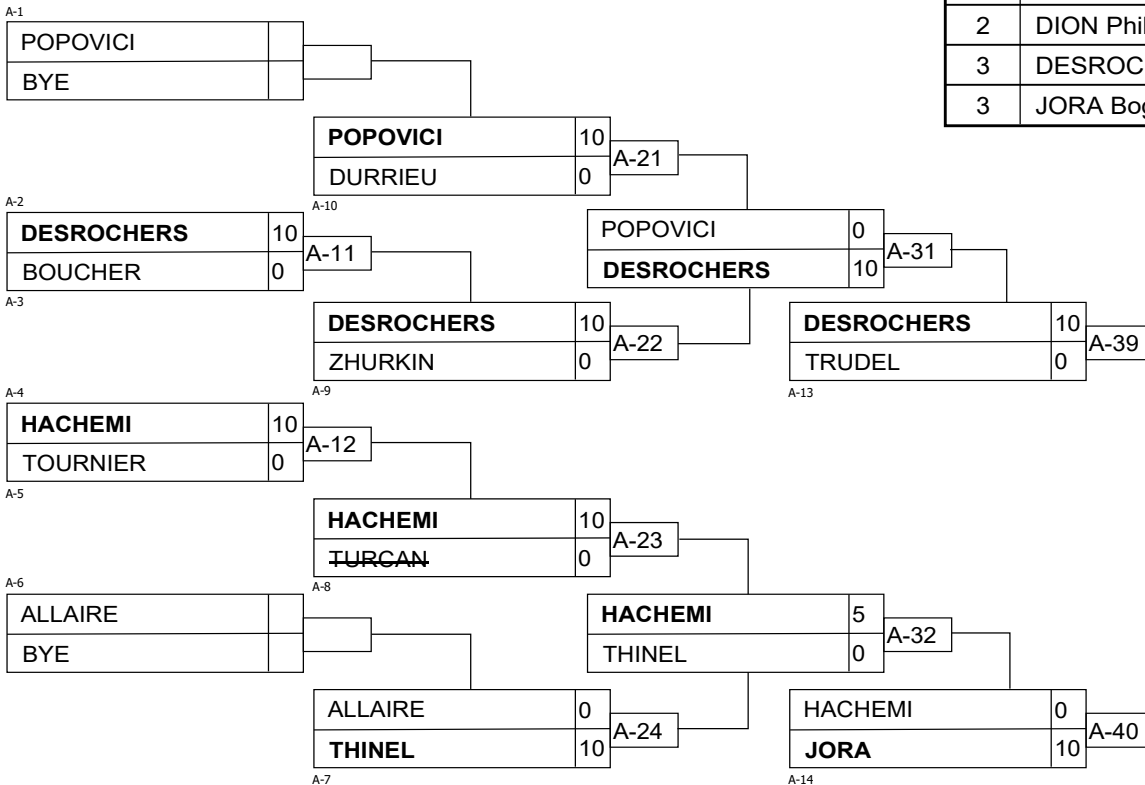

# U21/SenB M -73

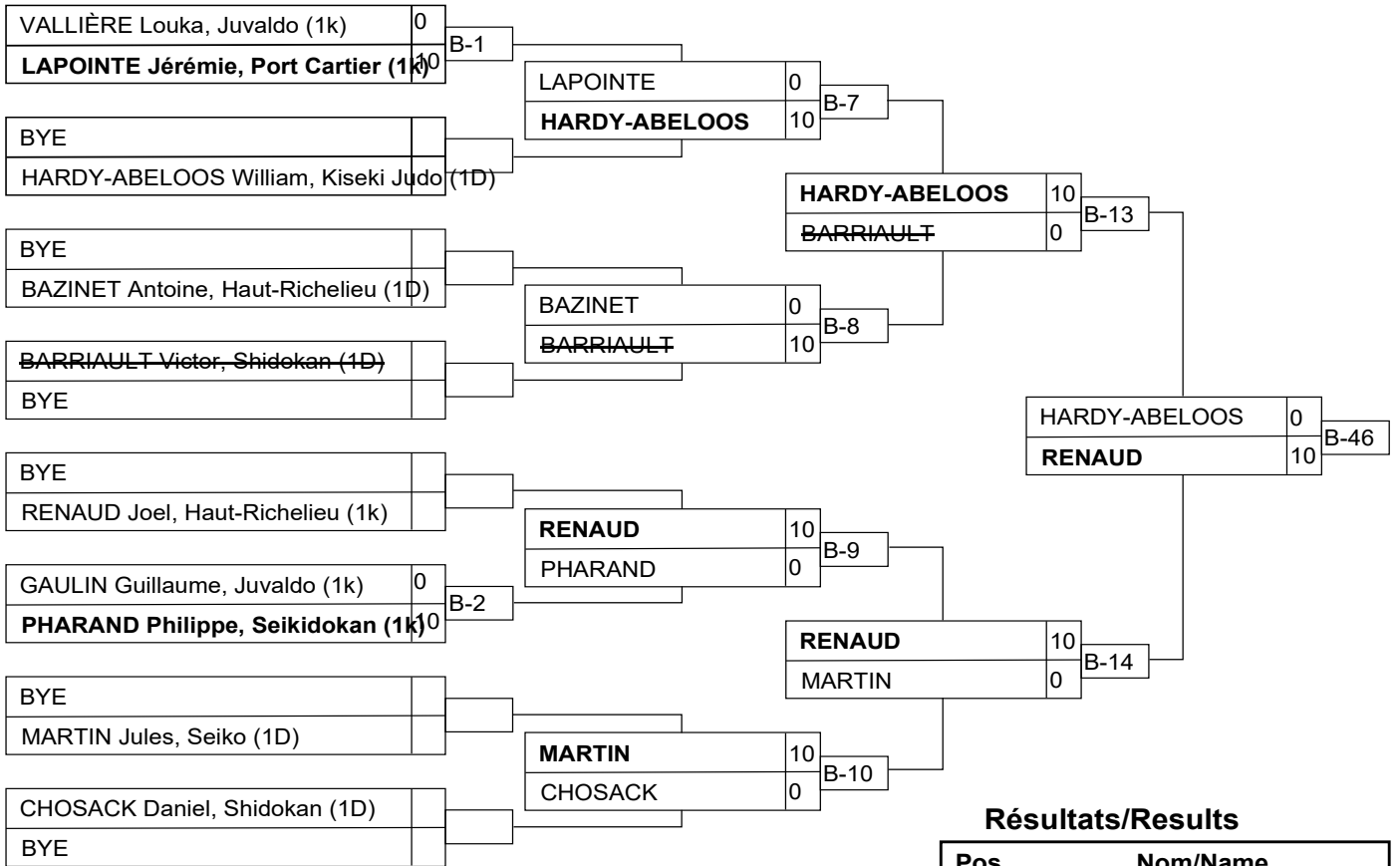

## Résultats/Results

Pos	Nom/Name
1	RENAUD Joel, Haut-Richelieu (1k)
2	HARDY-ABELOOS William, Kiseki Judo (1D)
3	PHARAND Philippe, Seikidokan (1k)
3	MARTIN Jules, Seiko (1D)

# U21/SenB M -81

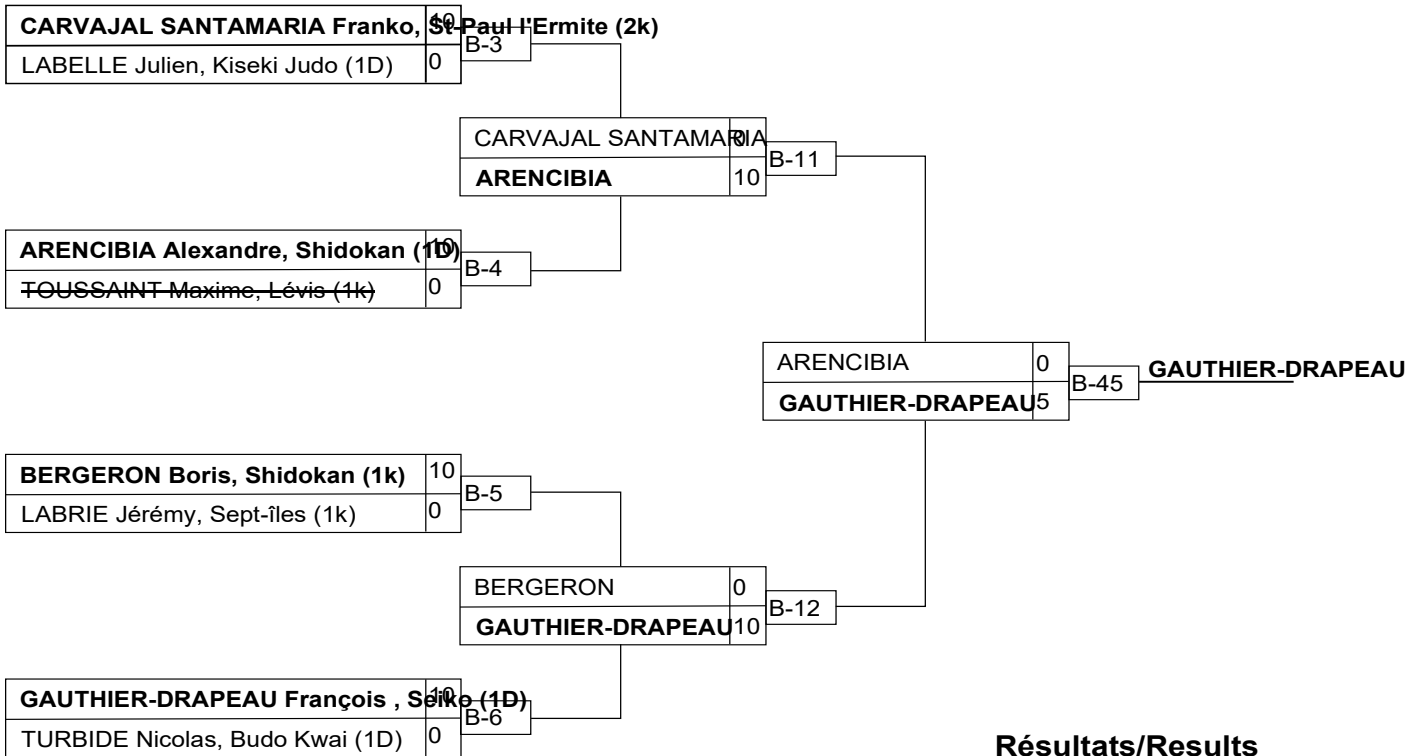

## Résultats/Results

Pos	Nom/Name
1	GAUTHIER-DRAPEAU François, Seiko
2	ARENCIBIA Alexandre, Shidokan (1D)
3	TURBIDE Nicolas, Budo Kwai (1D)
3	BERGERON Boris, Shidokan (1k)

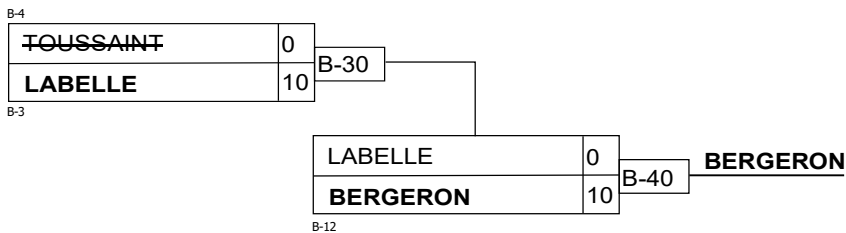
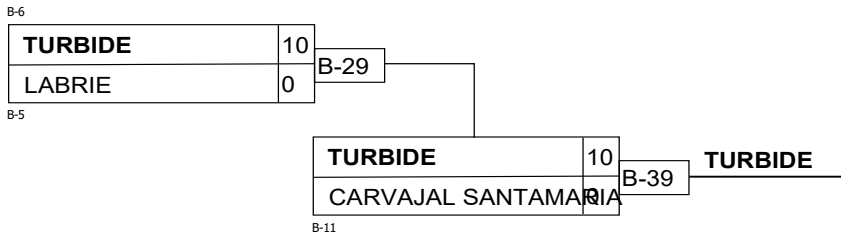



# U21/SenB M +100

## Compétiteurs/Competitors

#	Nom/Name	Grade	Club	1	G/W	Pts	Pos
1	ABA Ramy	1k	St-Paul l'Ermite	XX	0	0	1

## Matches/Matches

Match	Blanc/White	Bleu/Blue	Rés/Res	Tmp/Tim	Code
-------	-------------	-----------	---------	---------	------

## Résultats/Results

Pos	Nom/Name