

# Omnium 2016 4-5 novembre 2016 Montréal SenF +78

Competitors: 4

## Competitors

#	Name	Grade	Club	1	2	3	4	Wins	Pts	Pos
1	MORGENROTH Josephine	1k	ON		10		10	2	20	2
2	MCALPINE Amanda	2k	ON					0	0	4
3	DARLOW Annabelle	2k	AB	1	10		10	3	21	1
4	MALLETTE Roxanne	1k	QC		10			1	10	3

## Matches

Match	White			Blue	Result	Time	Code
B-8	<b>MORGENROTH Josephine</b>	1	2	MCALPINE Amanda	10 - 0	1:06	WIP
B-17	<b>DARLOW Annabelle</b>	3	4	MALLETTE Roxanne	10 - 0	2:15	WIP
B-24	MORGENROTH Josephine	1	3	<b>DARLOW Annabelle</b>	0 - 1	4:00	YUS
B-33	MCALPINE Amanda	2	4	<b>MALLETTE Roxanne</b>	0 - 10	0:46	WIP
B-43	<b>MORGENROTH Josephine</b>	1	4	MALLETTE Roxanne	10 - 0	2:03	WIP
B-53	MCALPINE Amanda	2	3	<b>DARLOW Annabelle</b>	0 - 10	2:10	WIP

## Results

Pos	Name
1	DARLOW Annabelle, AB
2	MORGENROTH Josephine, ON
3	MALLETTE Roxanne, QC
4	MCALPINE Amanda, ON

# Omnium 2016 4-5 novembre 2016 Montréal SenF -48

Competitors: 3

## Competitors

#	Name	Grade	Club	1	2	3	Wins	Pts	Pos
1	NEMETH Virginia	1D	AB		1		1	1	2
2	KAEGI Lorena	1D	MB				0	0	3
3	MORGAN Erin	2D	AB	5	10		2	15	1

## Matches

Match	White			Blue	Result	Time	Code
E-24	<b>NEMETH Virginia</b>	1	2	KAEGI Lorena	1 - 0	5:39	GSD
E-38	NEMETH Virginia	1	3	<b>MORGAN Erin</b>	0 - 5	5:13	GSY
E-54	KAEGI Lorena	2	3	<b>MORGAN Erin</b>	0 - 10	1:48	IPO

## Results

Pos	Name
1	MORGAN Erin, AB
2	NEMETH Virginia, AB
3	KAEGI Lorena, MB

# Omnium 2016 4-5 novembre 2016 Montréal SenF -52

Competitors: 6

## Competitors A

#	Name	Grade	Club	1	2	3	Wins	Pts	Pos
1	SPARKS Amelia	2k	NS				0	0	3
2	BELLALI Yumi Amal	1D	QC	10		10	2	20	1
3	OUELLETTE Vanessa	1D	NB	10			1	10	2

## Matches A

Match	White	Blue	Result	Time	Code
D-8	SPARKS Amelia 1 2	BELLALI Yumi Amal	0 - 10	0:27	WIP
D-19	SPARKS Amelia 1 3	OUELLETTE Vanessa	0 - 10	1:04	WIP
D-29	BELLALI Yumi Amal 2 3	OUELLETTE Vanessa	10 - 0	1:38	WIP

## Competitors B

#	Name	Grade	Club	4	5	6	Wins	Pts	Pos
4	MELKO Vanda	1k	QC		10		1	10	2
5	BROWN Lorie	1k	NS				0	0	3
6	KOLIASKA Taeya	1D	AB	10	10		2	20	1

## Matches B

Match	White	Blue	Result	Time	Code
D-14	MELKO Vanda 4 5	BROWN Lorie	10 - 0	1:13	IPO
D-26	MELKO Vanda 4 6	KOLIASKA Taeya	0 - 10	3:02	HAN
D-37	BROWN Lorie 5 6	KOLIASKA Taeya	0 - 10	0:42	IPO

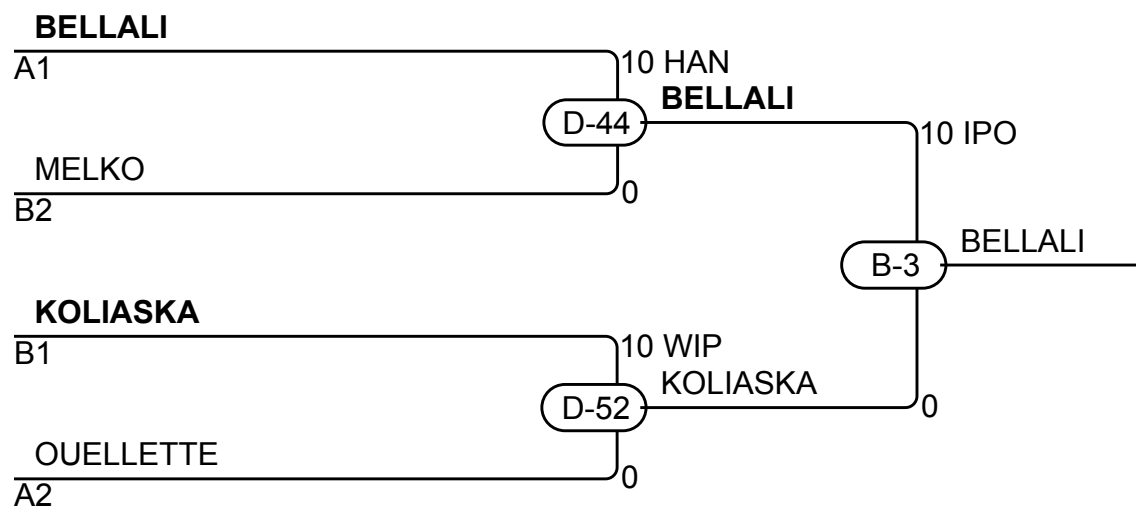

## Results

Pos	Name
1	BELLALI Yumi Amal, QC
2	KOLIASKA Taeya, AB
3	MELKO Vanda, QC
3	OUELLETTE Vanessa, NB

# SenF -57

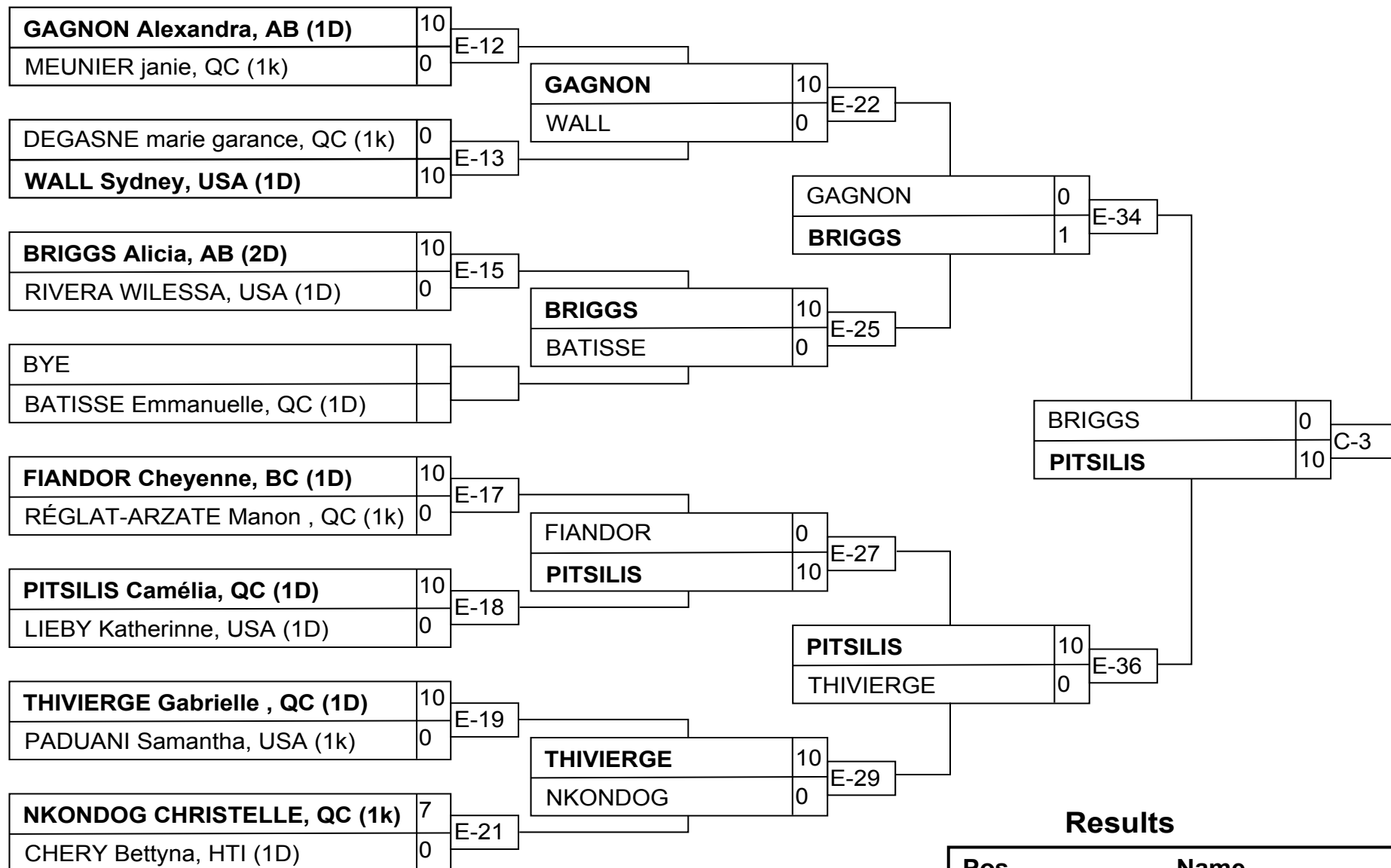

## Results

Pos	Name
1	PITSILIS Camélia, QC (1D)
2	BRIGGS Alicia, AB (2D)
3	GAGNON Alexandra, AB (1D)
3	THIVIERGE Gabrielle , QC (1D)

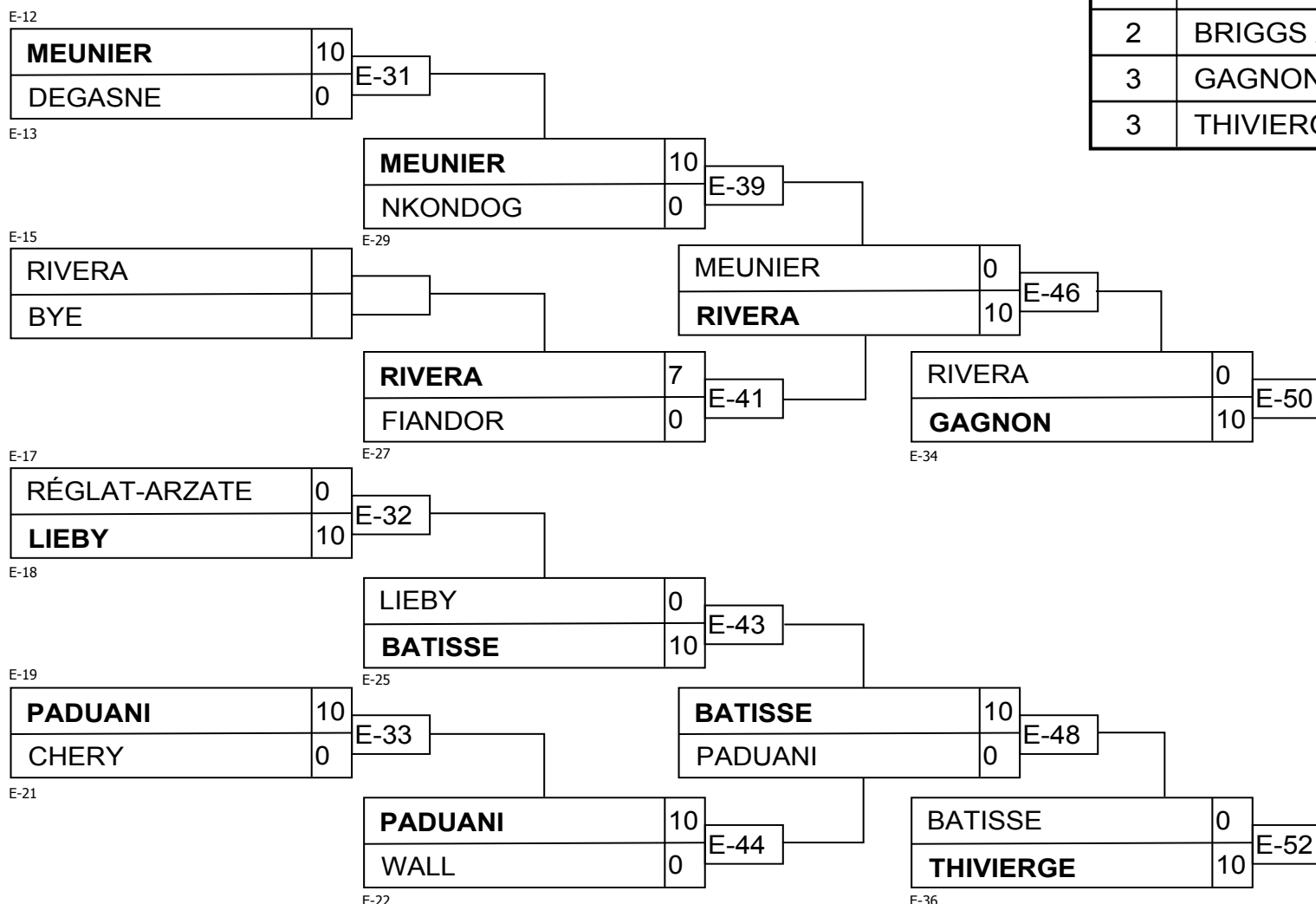

# SenF -63

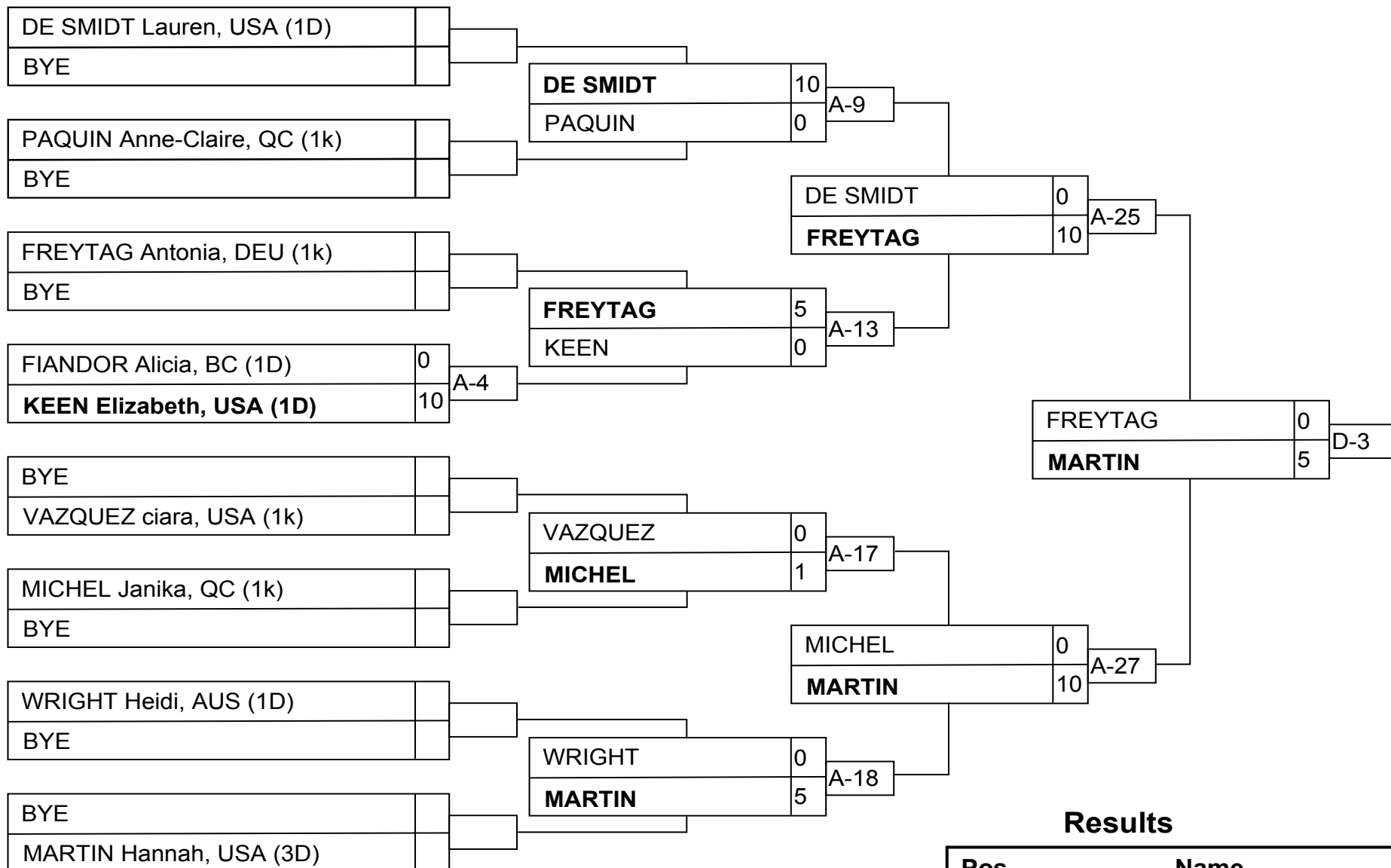

## Results

Pos	Name
1	MARTIN Hannah, USA (3D)
2	FREYTAG Antonia, DEU (1k)
3	WRIGHT Heidi, AUS (1D)
3	KEEN Elizabeth, USA (1D)

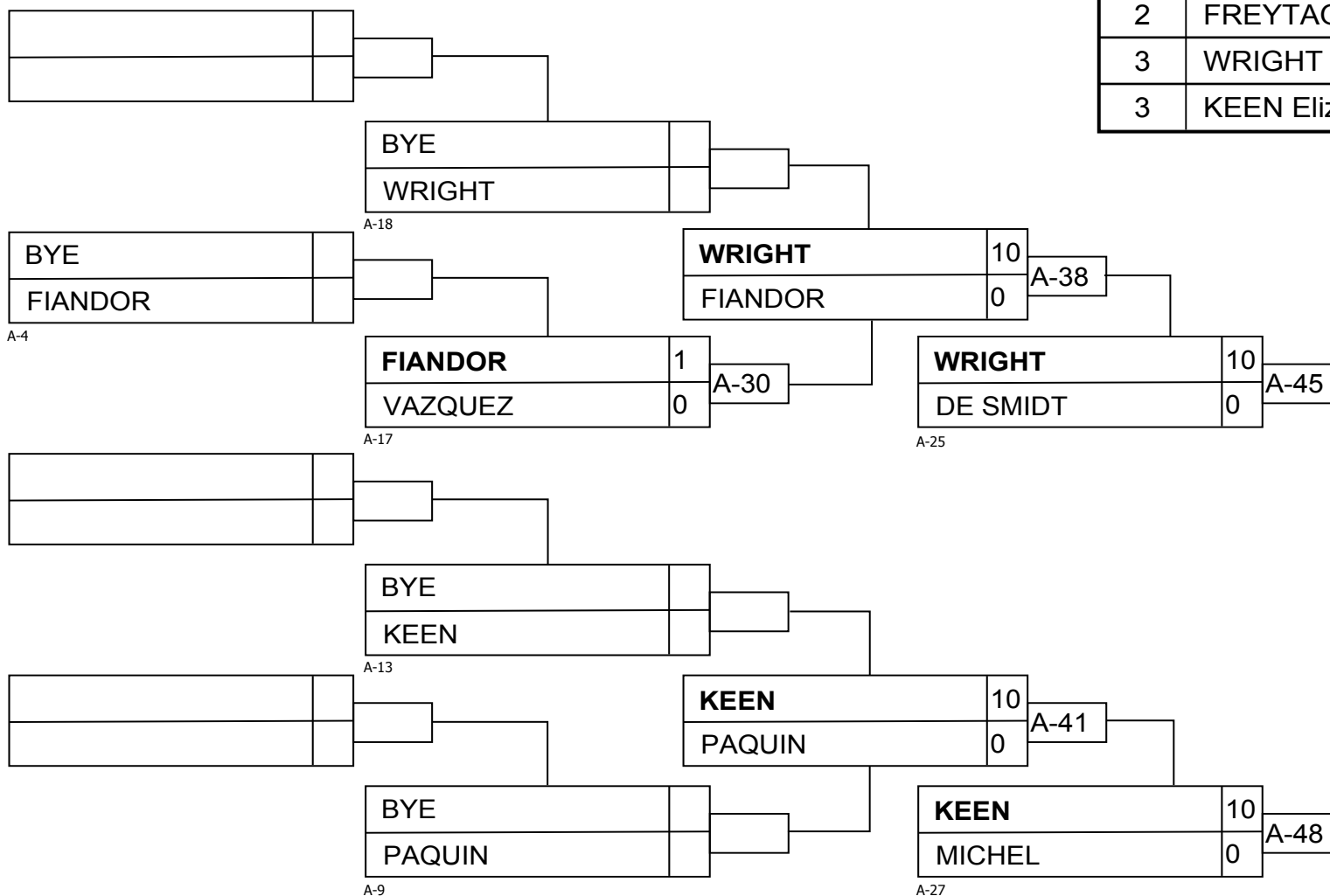

# SenF -70

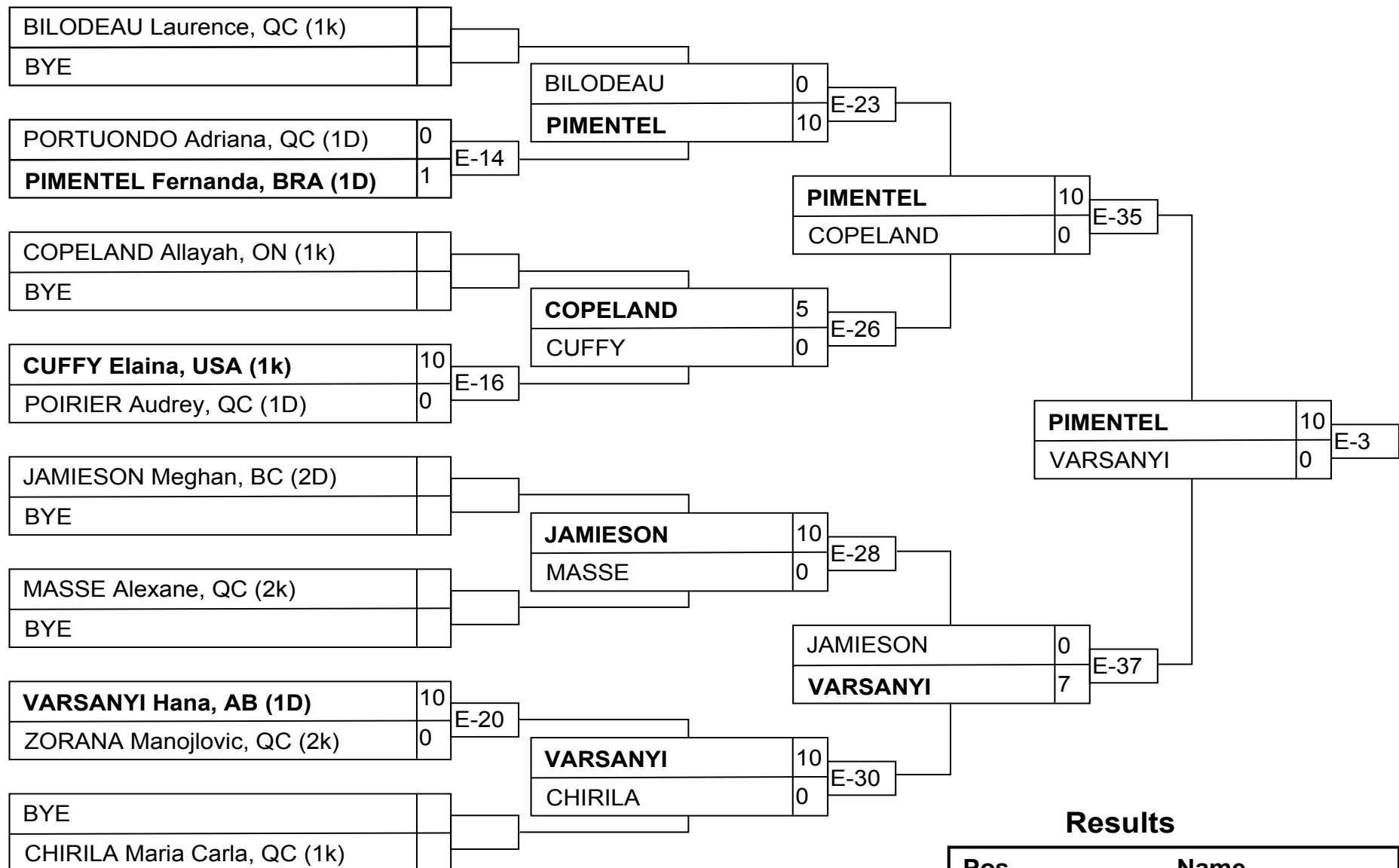

## Results

Pos	Name
1	PIMENTEL Fernanda, BRA (1D)
2	VARSAANYI Hana, AB (1D)
3	PORTUONDO Adriana, QC (1D)
3	JAMIESON Meghan, BC (2D)

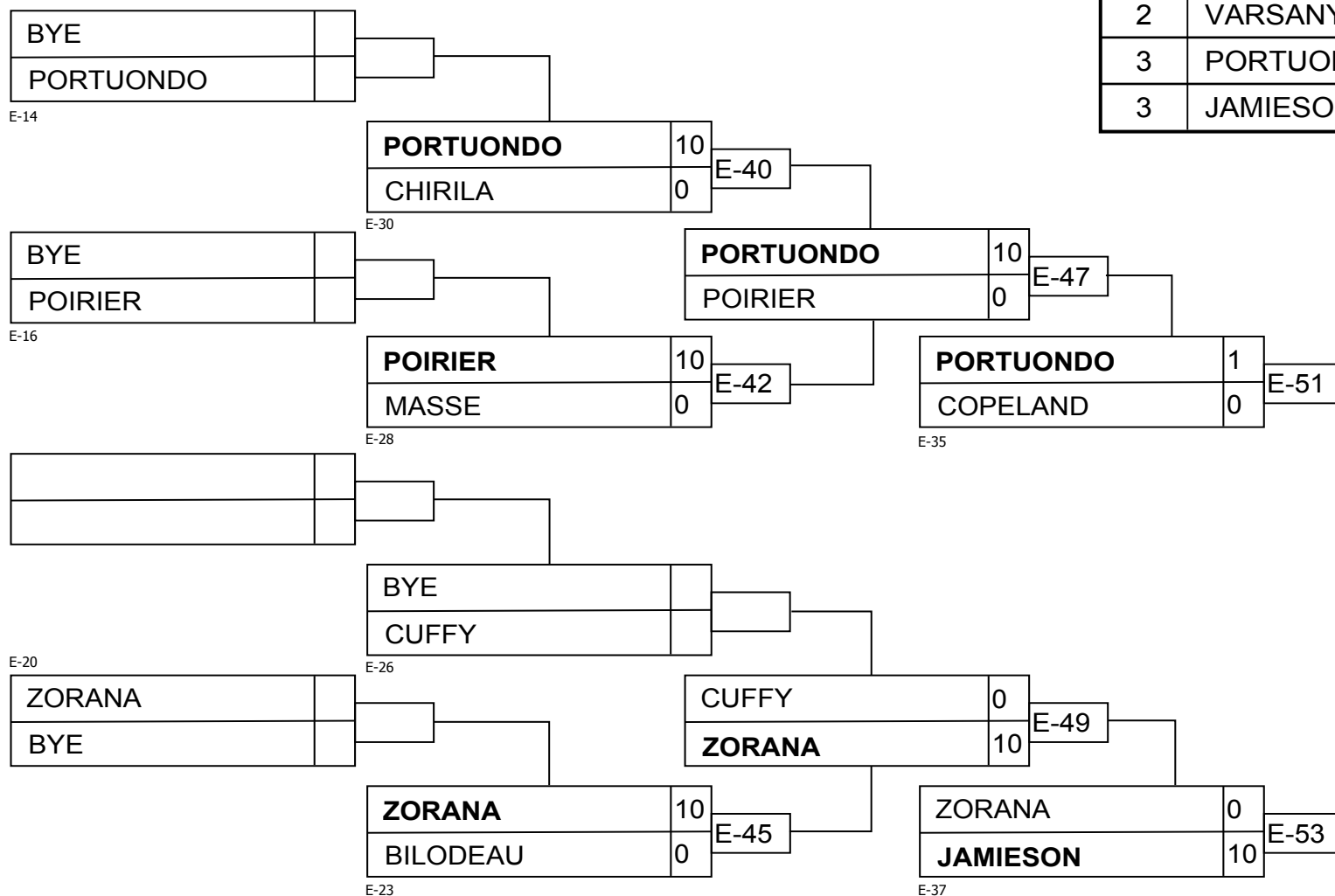

# SenF -78

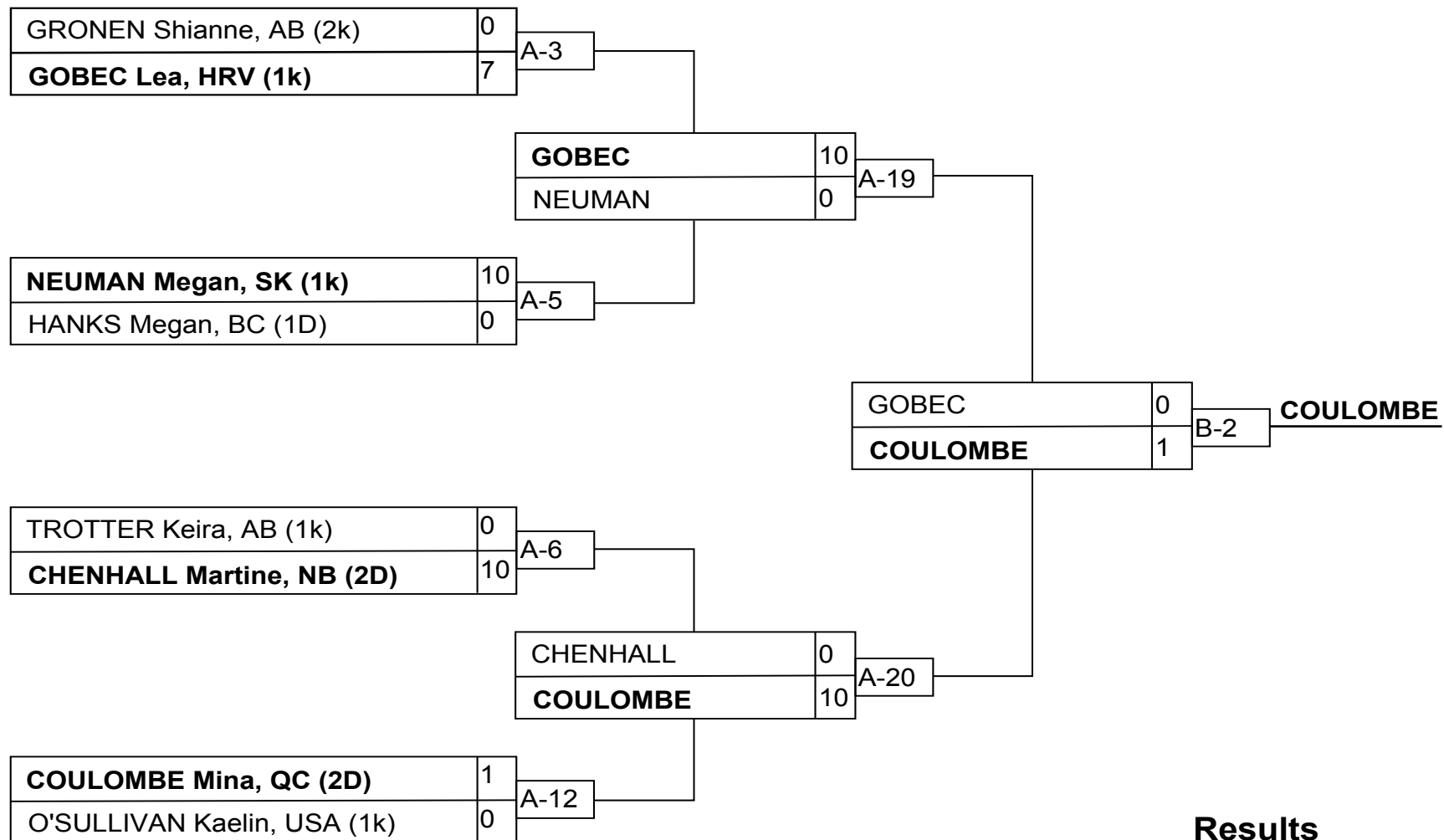

## Results

Pos	Name
1	COULOMBE Mina, QC (2D)
2	GOBEC Lea, HRV (1k)
3	O'SULLIVAN Kaelin, USA (1k)
3	GRONEN Shianne, AB (2k)

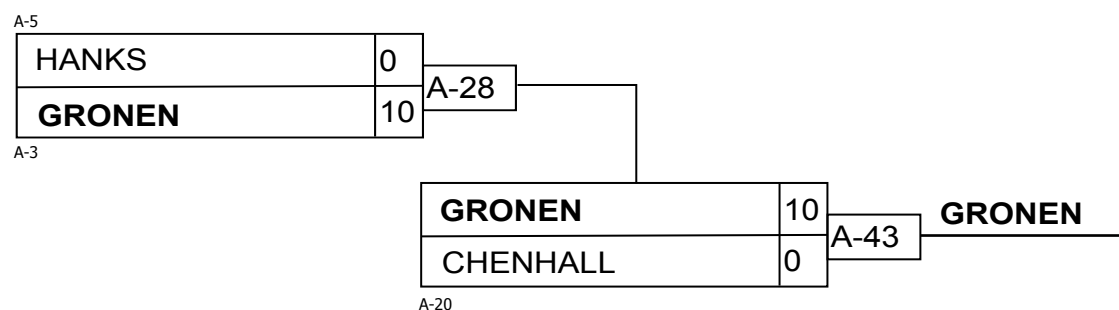
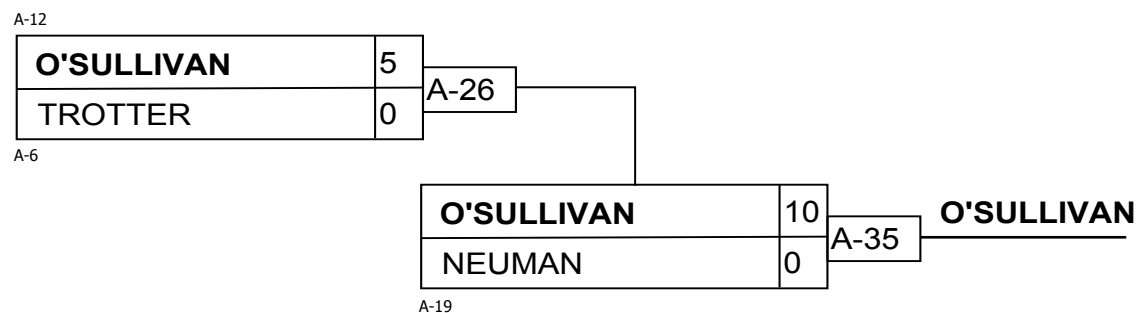

# SenM +100

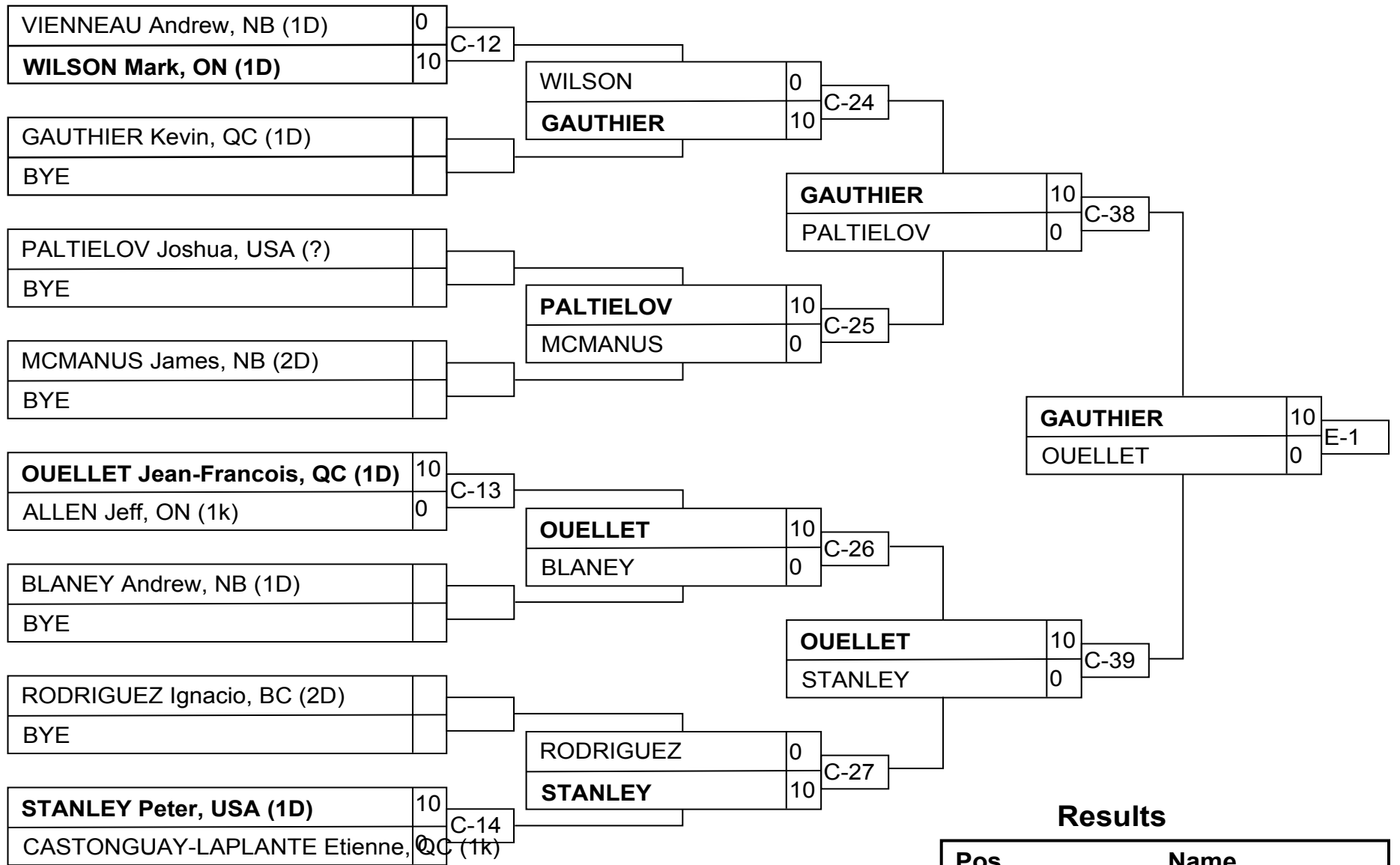

## Results

Pos	Name
1	GAUTHIER Kevin, QC (1D)
2	OUELLET Jean-Francois, QC (1D)
3	PALTIELOV Joshua, USA (?)
3	MCMANUS James, NB (2D)

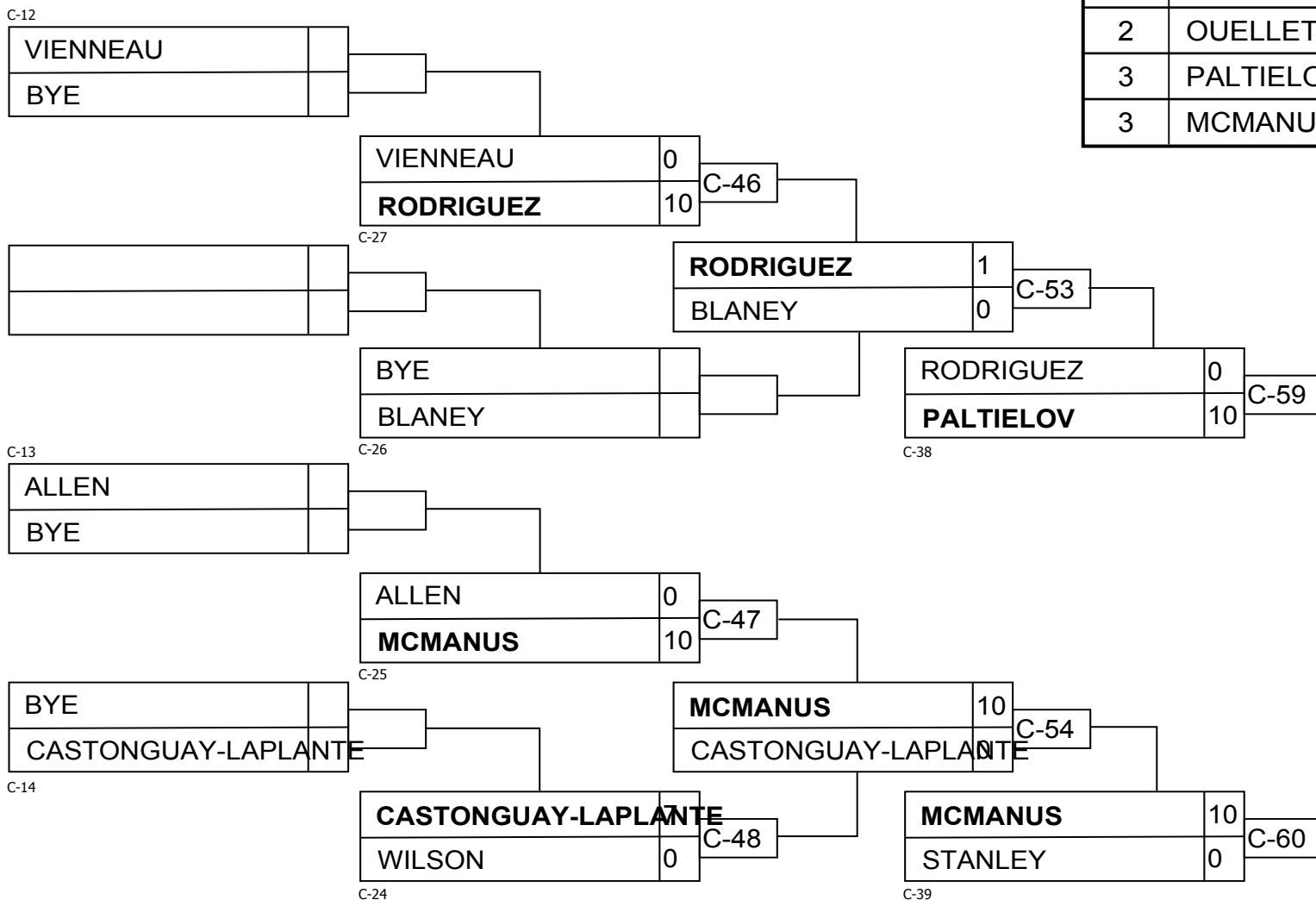



# SenM -100

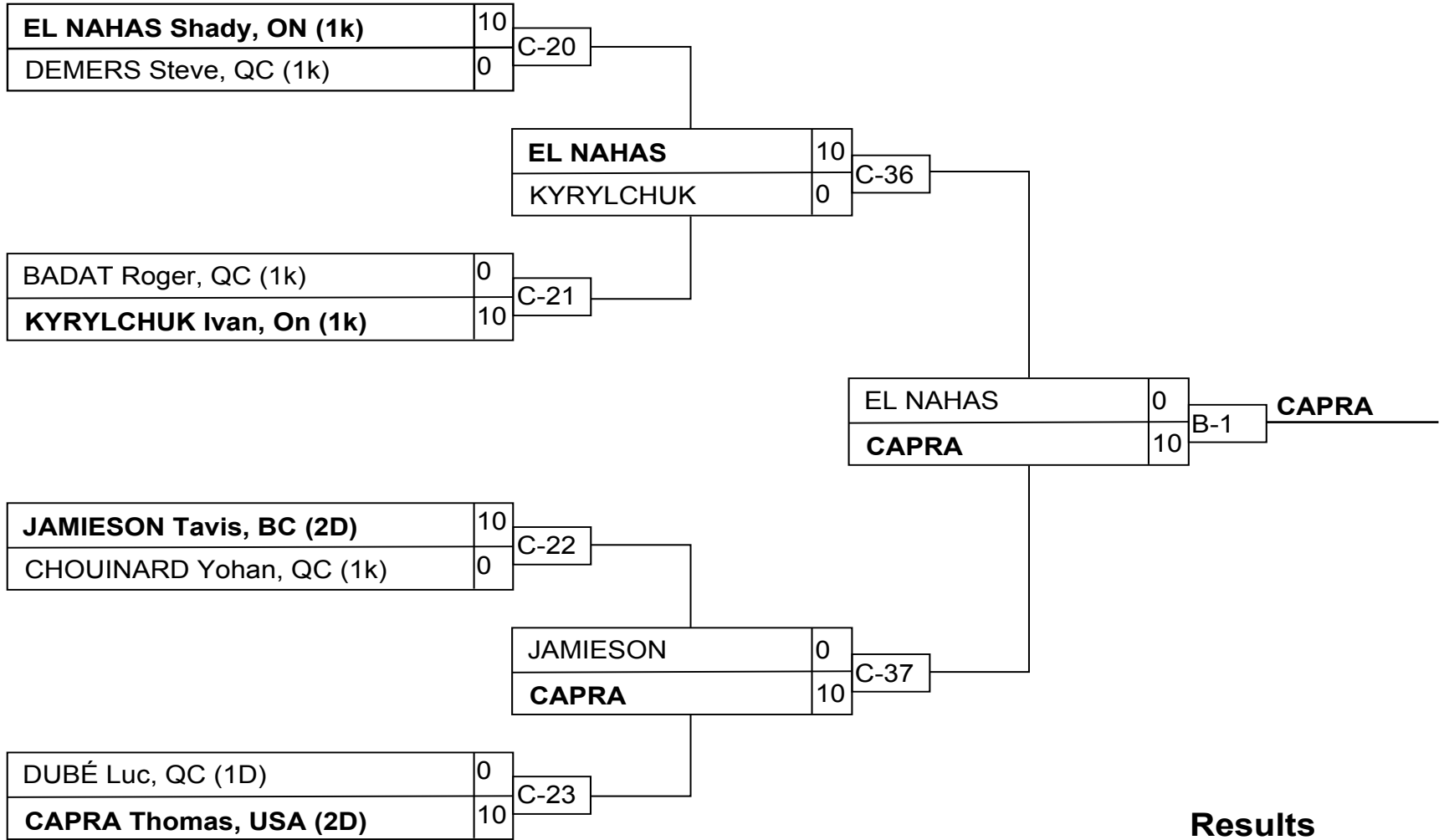

## Results

Pos	Name
1	CAPRA Thomas, USA (2D)
2	EL NAHAS Shady, ON (1k)
3	KYRYLCHUK Ivan, On (1k)
3	JAMIESON Tavis, BC (2D)

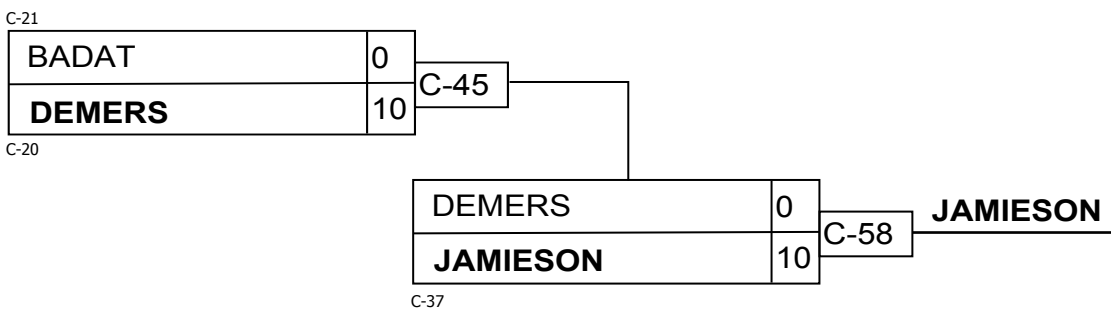
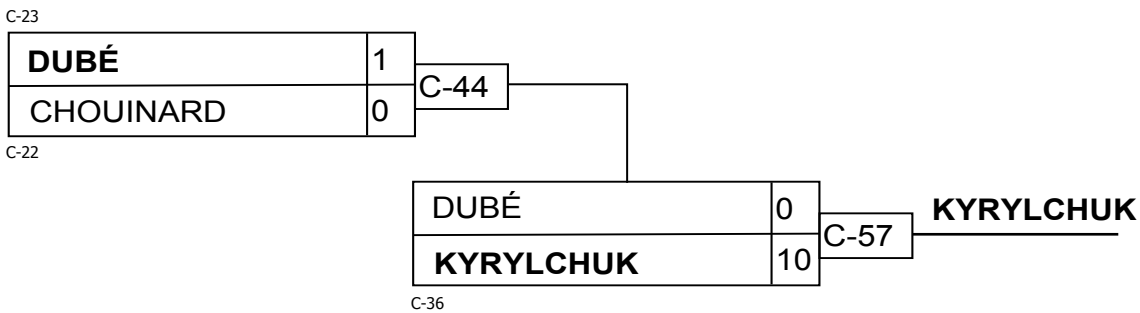

# SenM -60

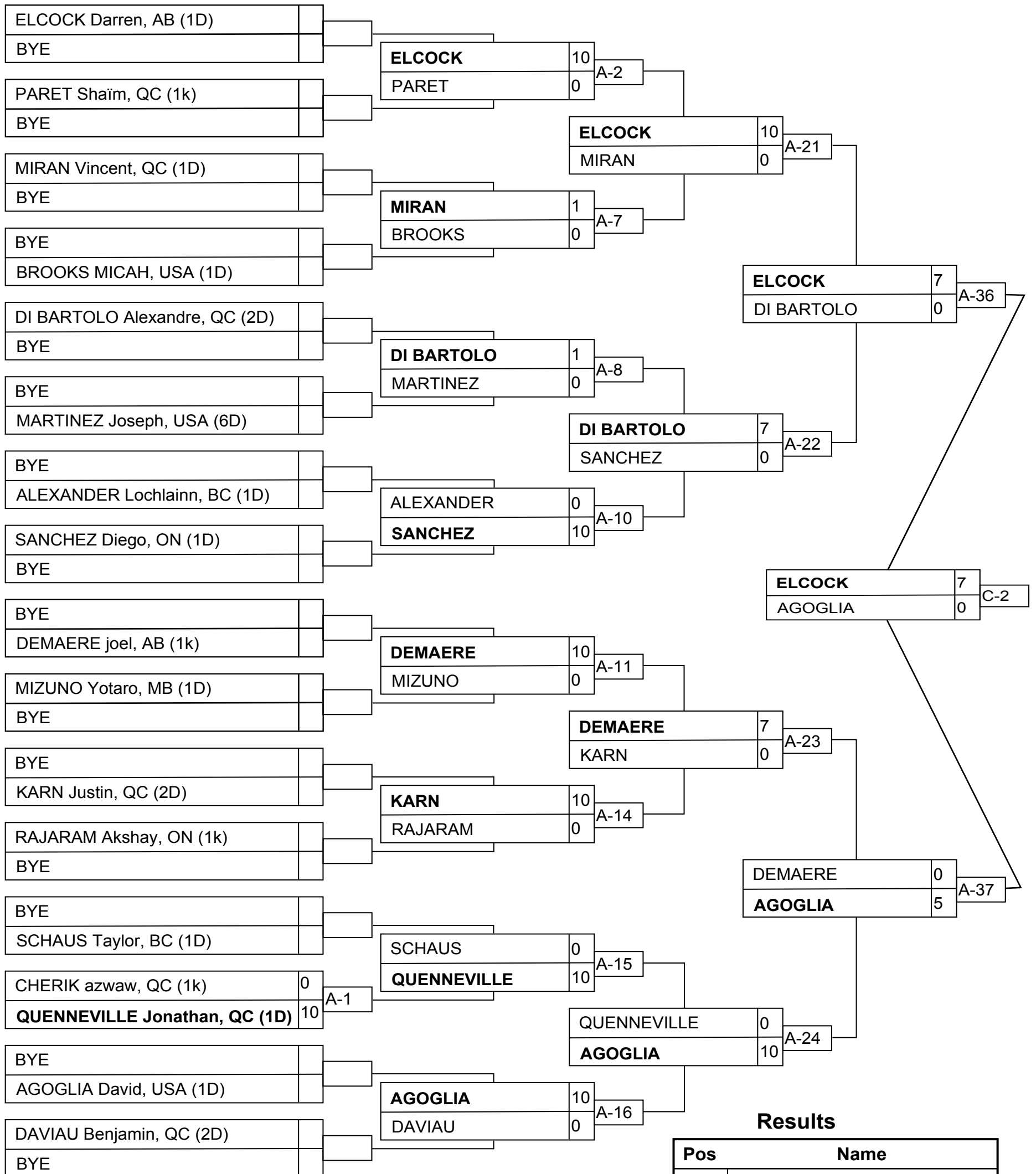

## Results

Pos	Name
1	ELCOCK Darren, AB (1D)
2	AGOGLIA David, USA (1D)
3	DI BARTOLO Alexandre, QC (2D)
3	DAVIAU Benjamin, QC (2D)

# SenM -60

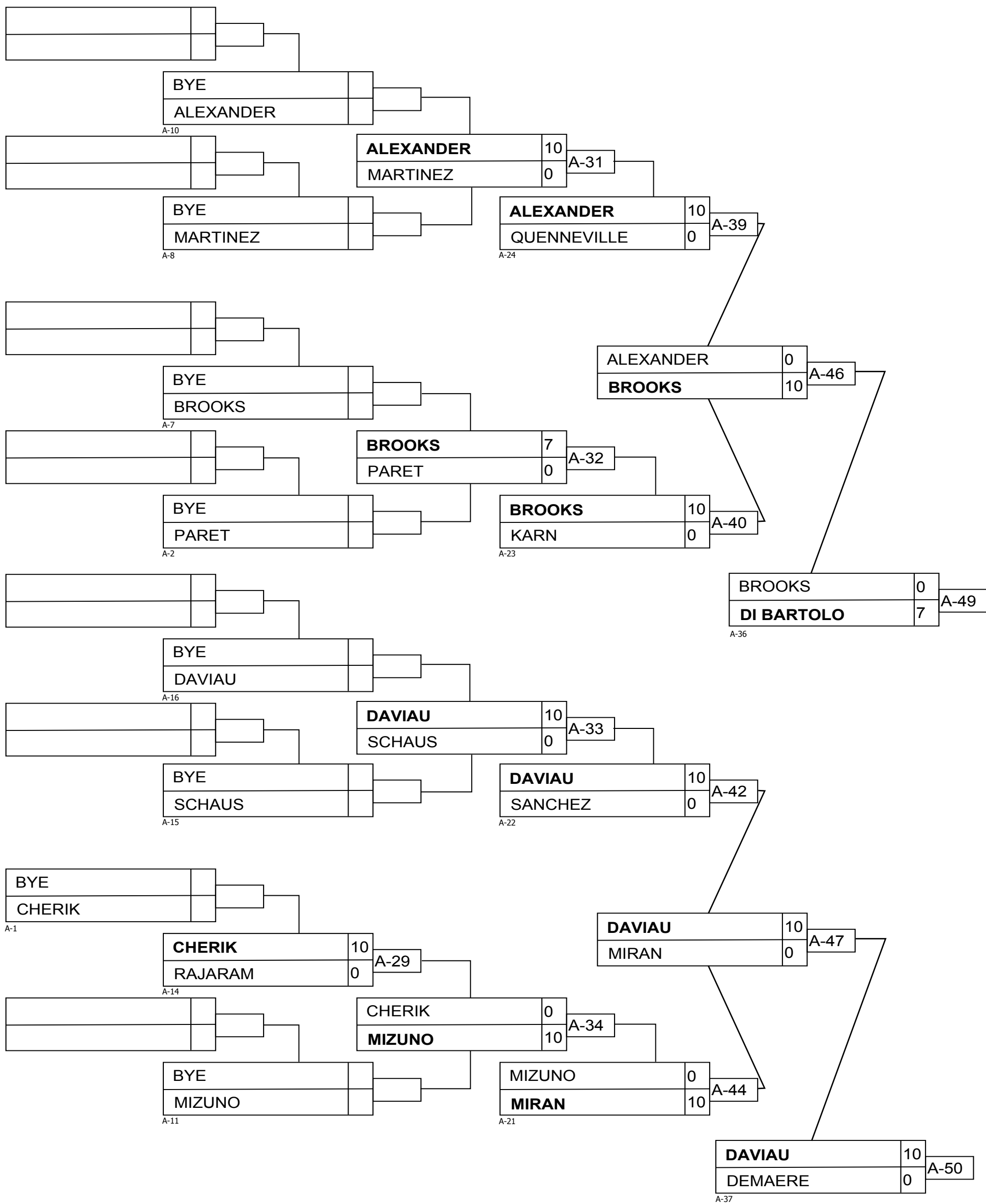

# SenM -66

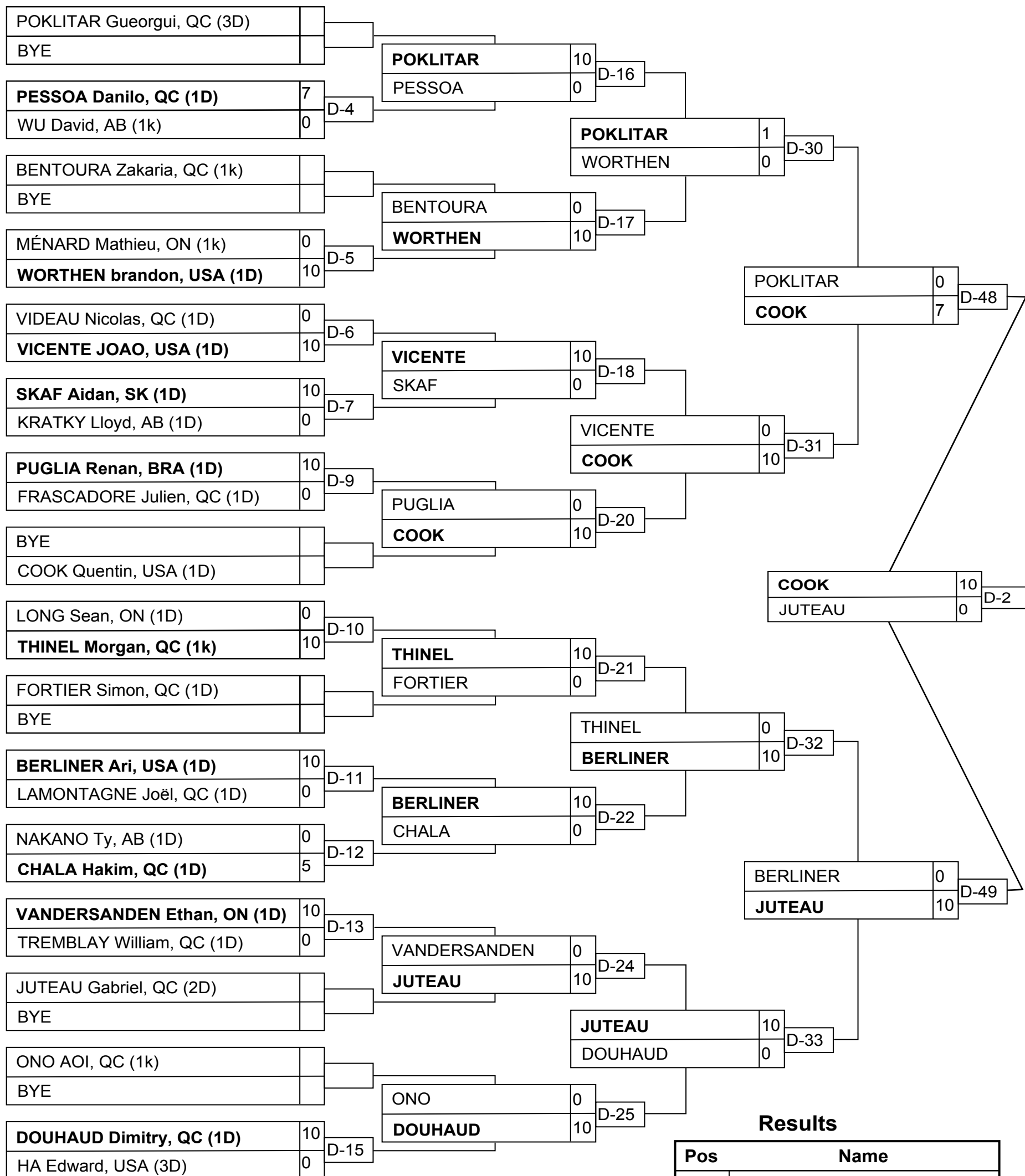

## Results

Pos	Name
1	COOK Quentin, USA (1D)
2	JUTEAU Gabriel, QC (2D)
3	POKLITAR Gueorgui, QC (3D)
3	BERLINER Ari, USA (1D)

# SenM -66

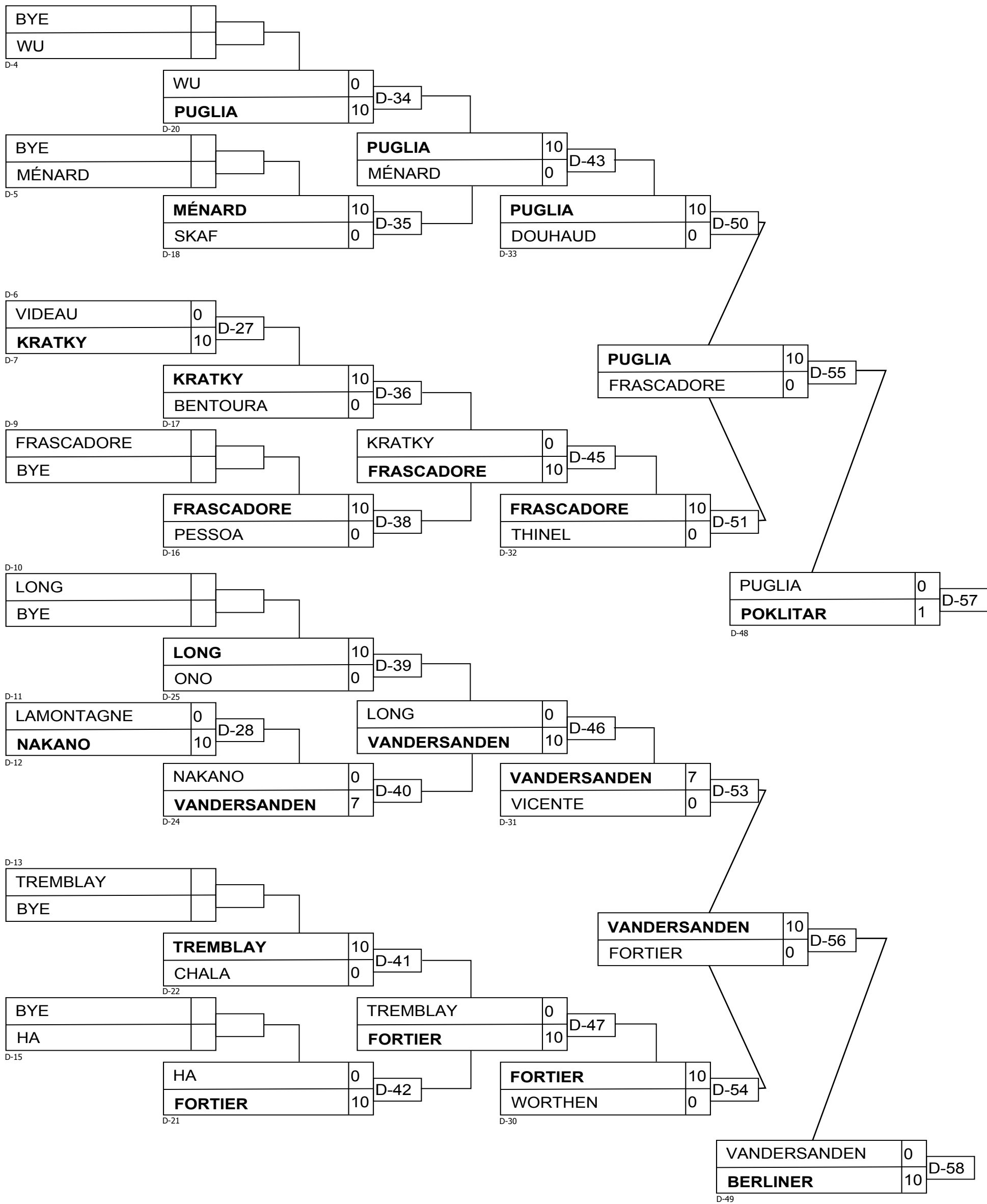

# SenM -73

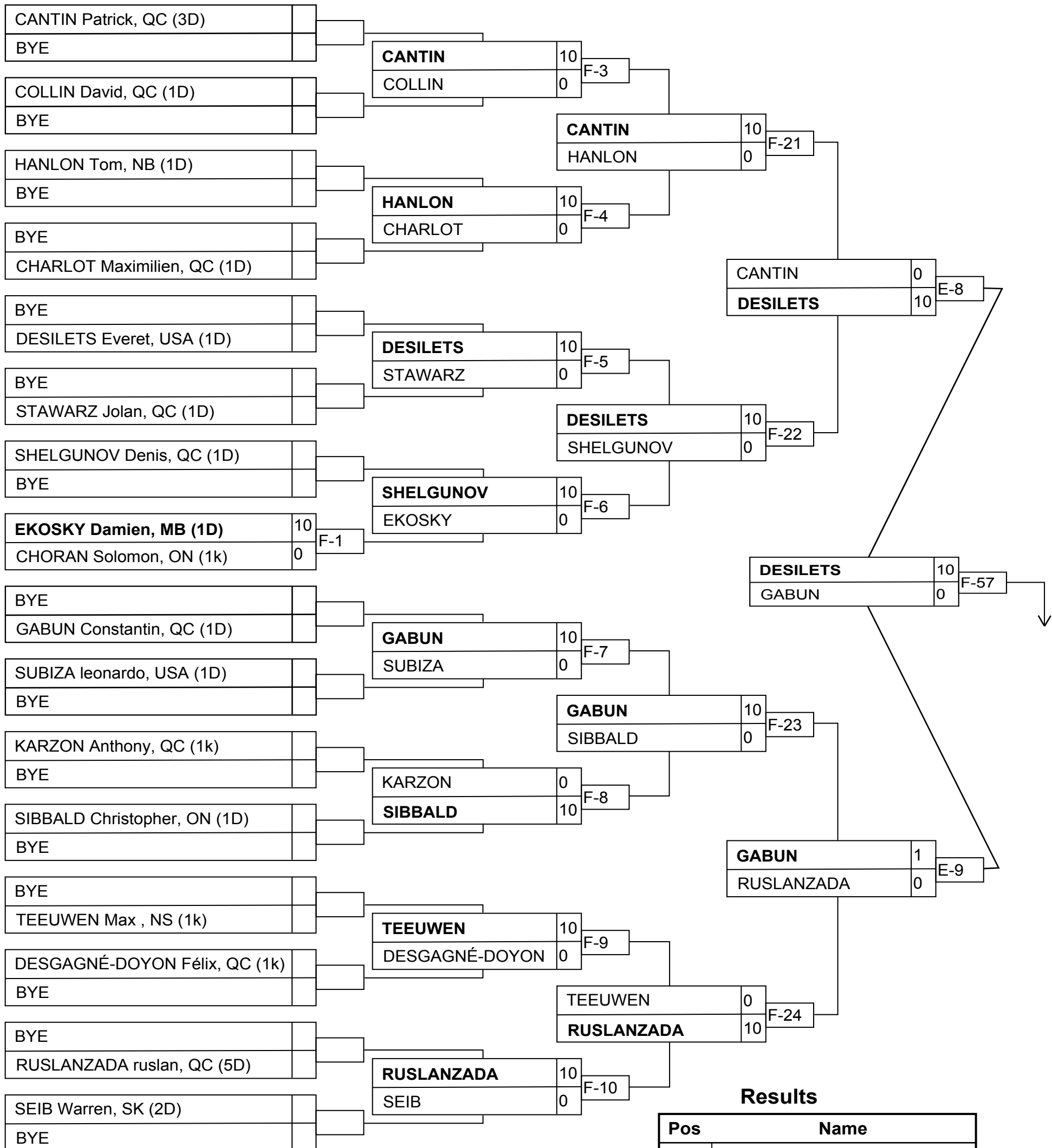

### Results

Pos	Name
1	DESILETS Everet, USA (1D)
2	LANGLOIS Bradley, ON (1D)
3	VACC Gabriel, QC (1D)
3	RUSLANZADA ruslan, QC (5D)

# SenM -73

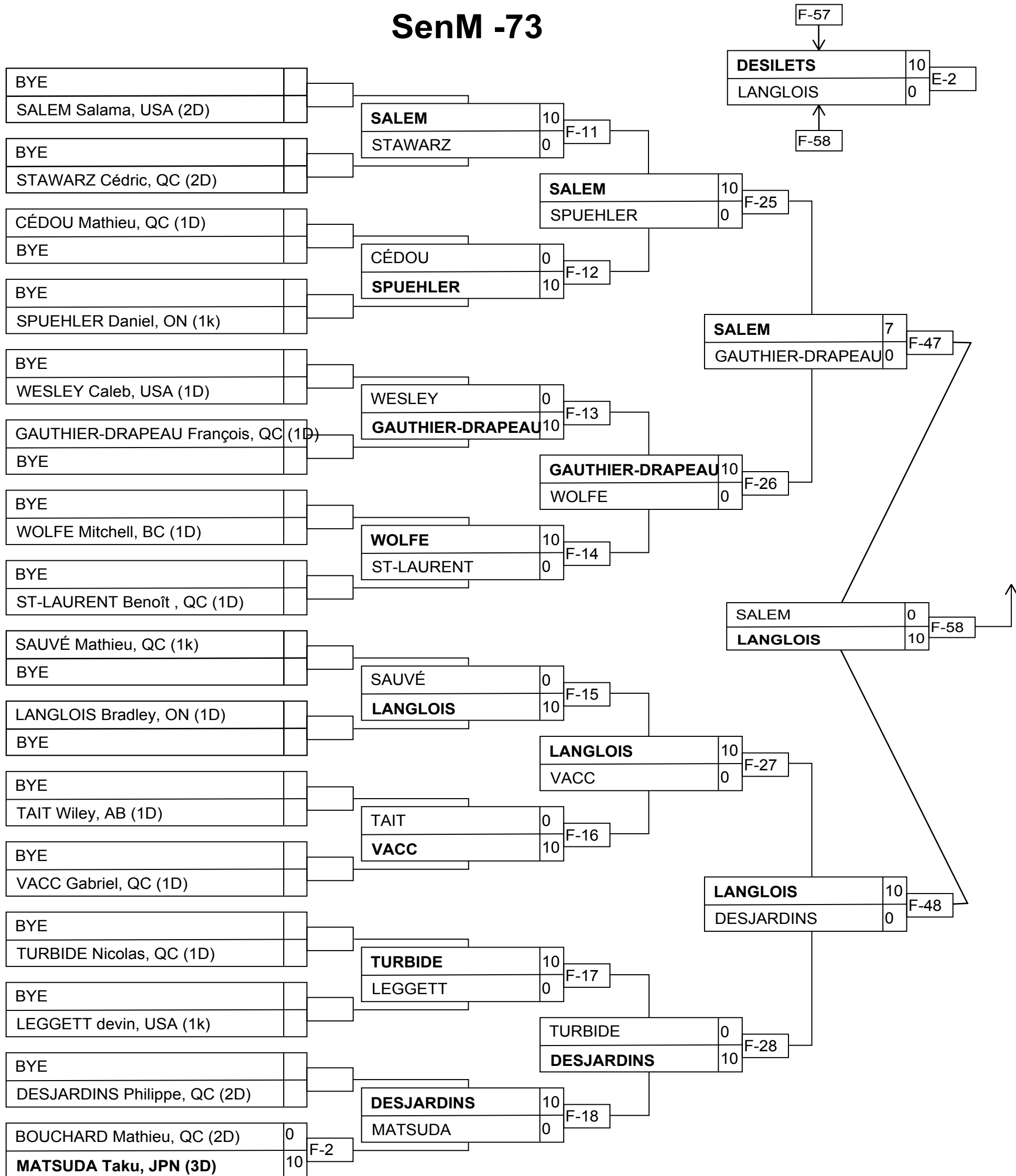

# SenM-73

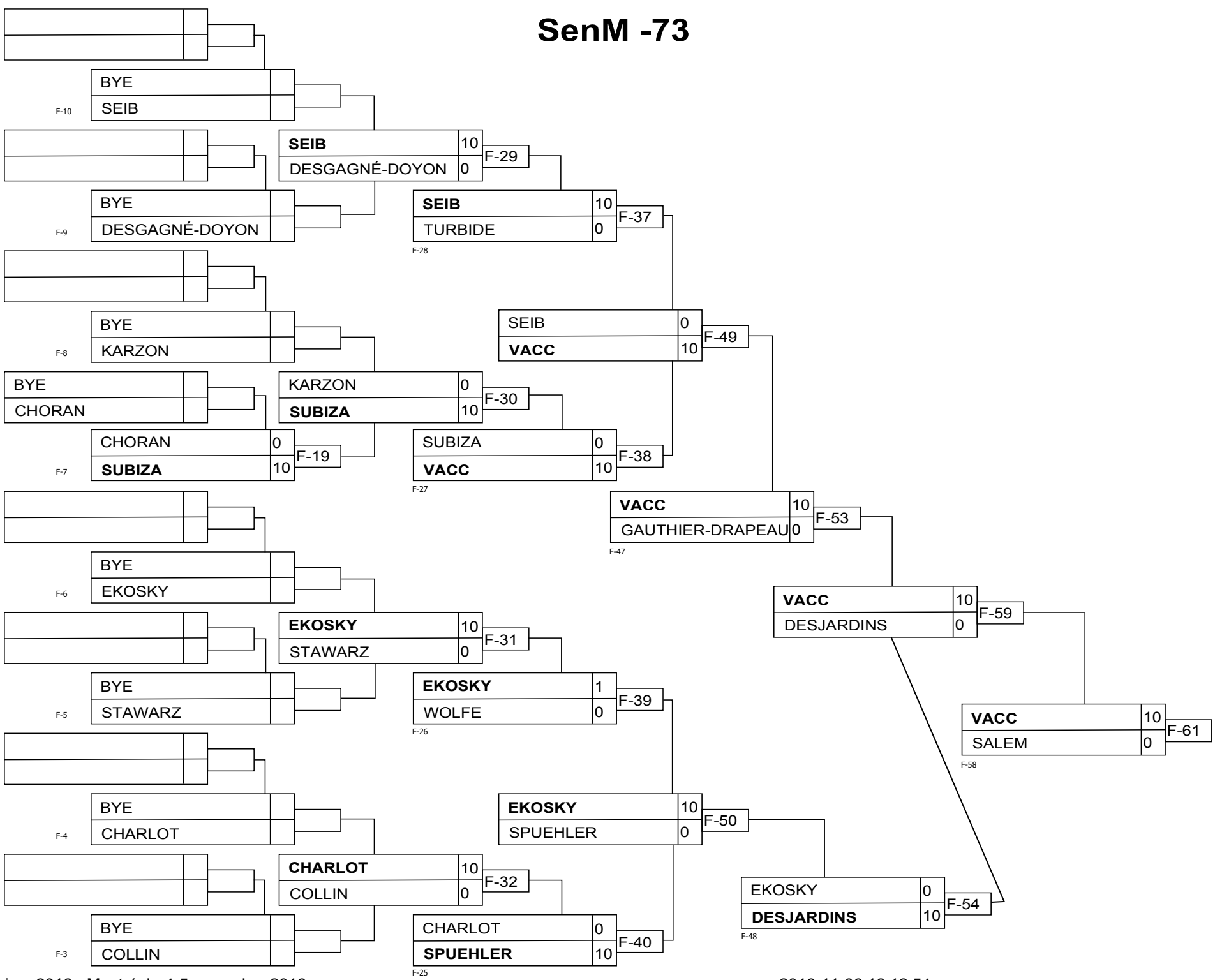



# SenM-73

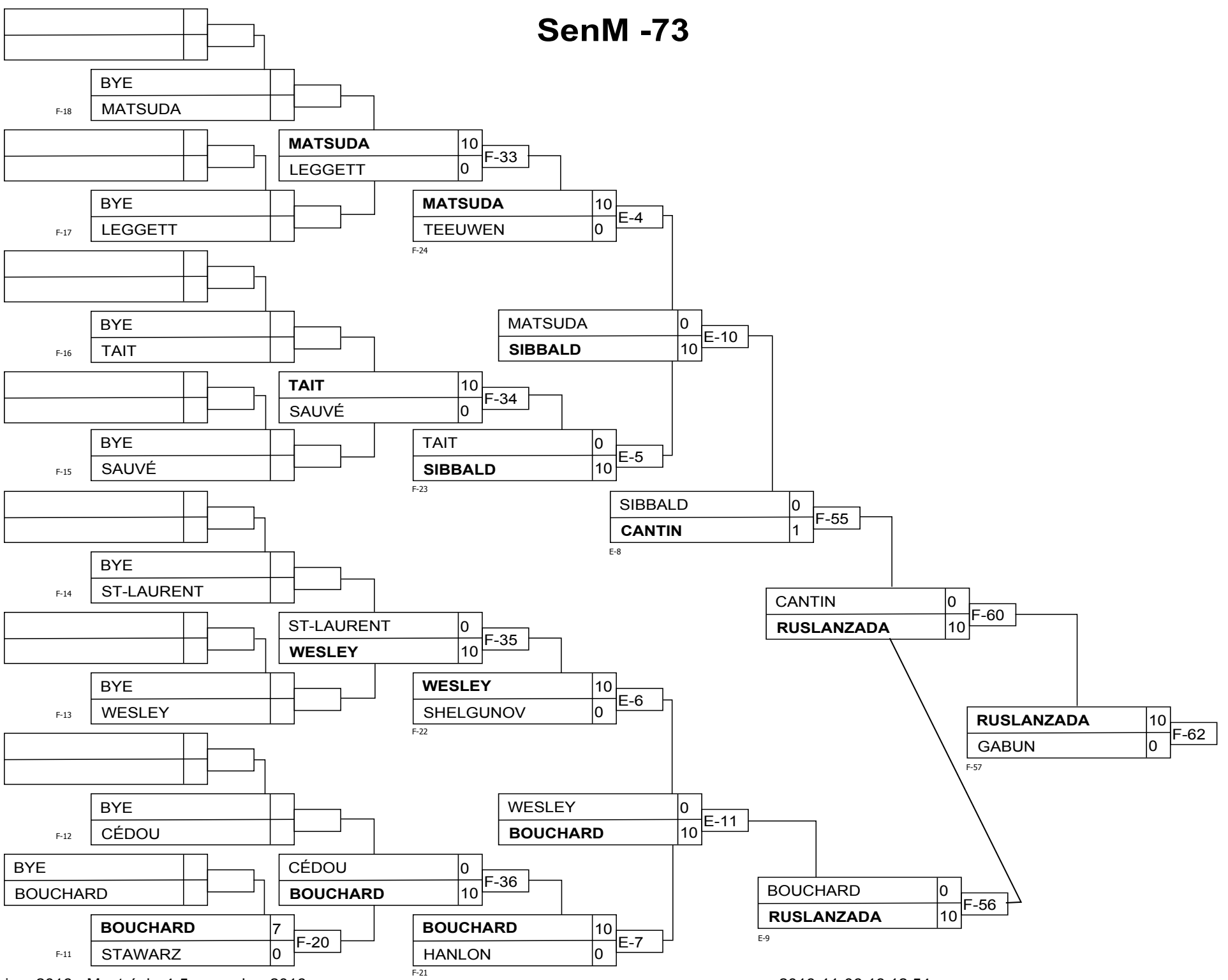

# SenM -81

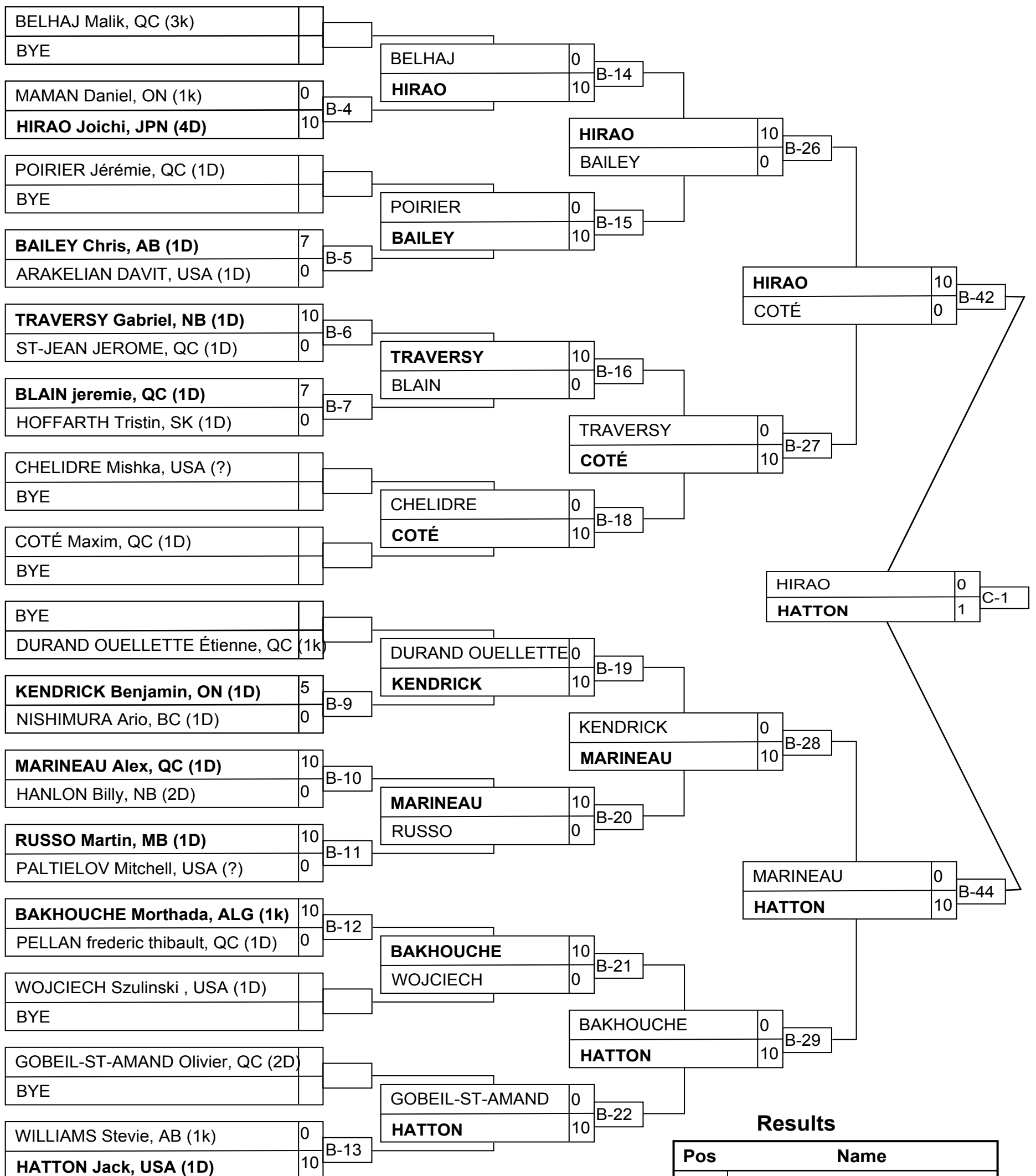

**Results**

Pos	Name
1	HATTON Jack, USA (1D)
2	HIRAO Joichi, JPN (4D)
3	KENDRICK Benjamin, ON (1D)
3	MARINEAU Alex, QC (1D)

# SenM -81

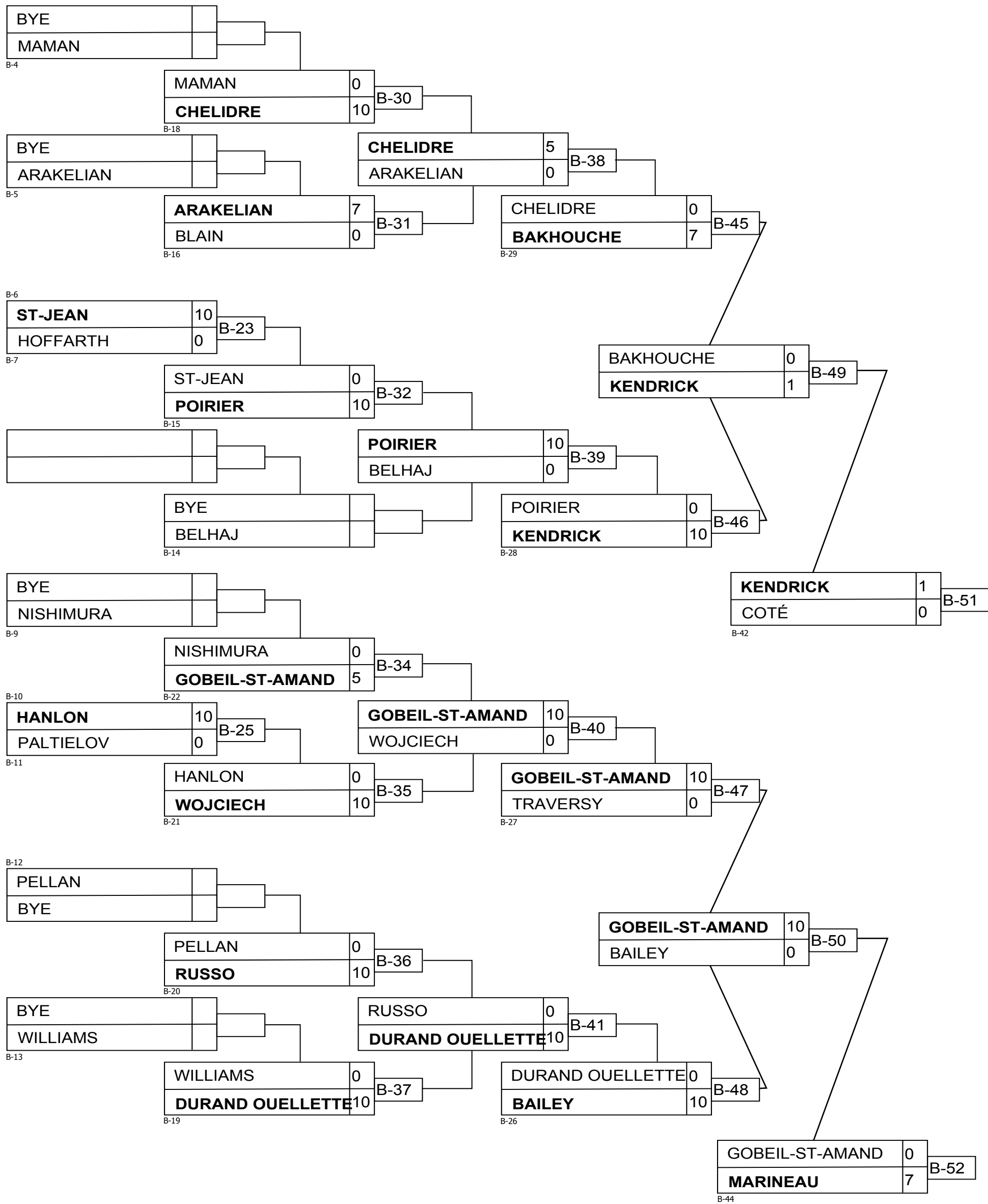

# SenM -90

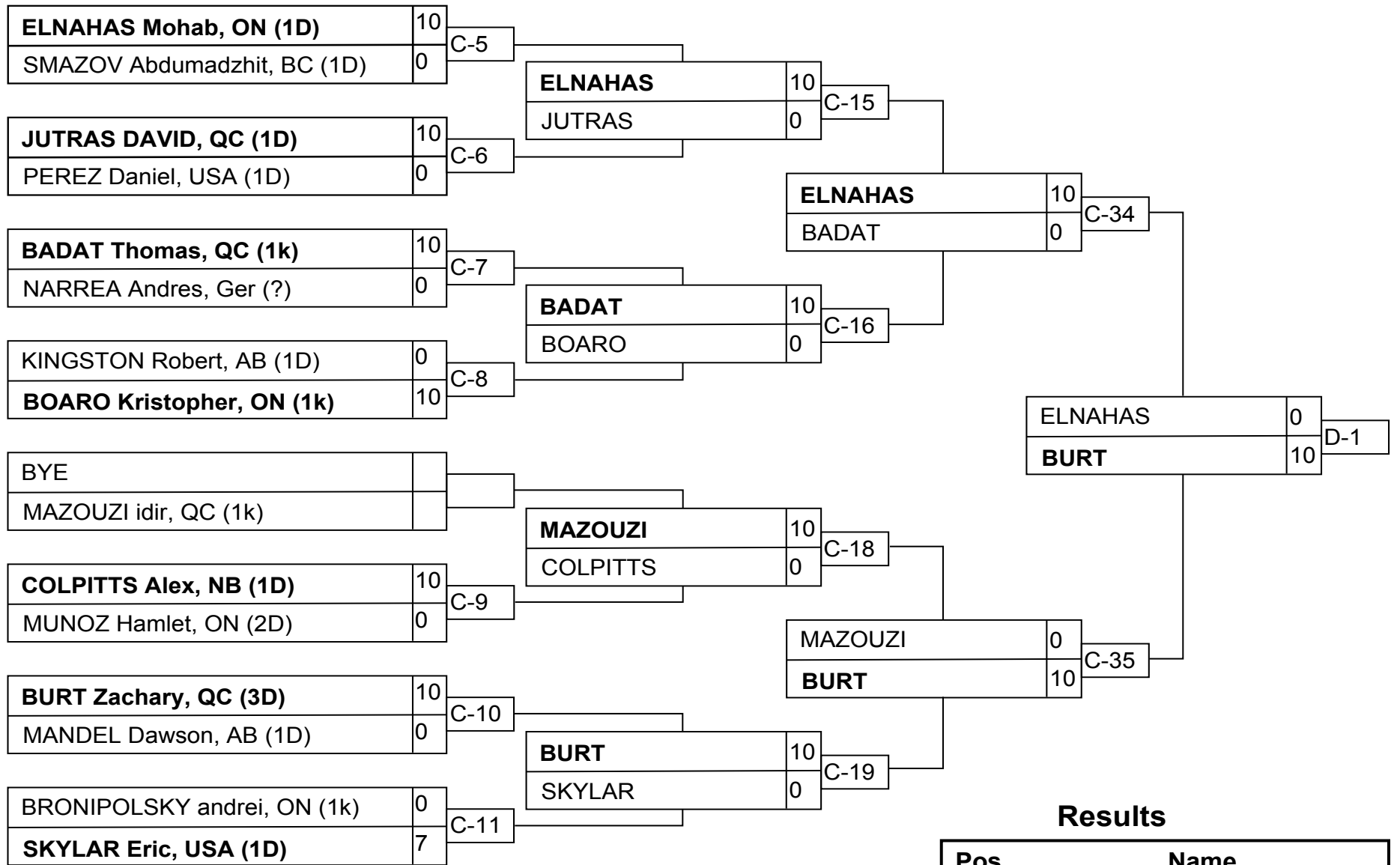

## Results

Pos	Name
1	BURT Zachary, QC (3D)
2	ELNAHAS Mohab, ON (1D)
3	BADAT Thomas, QC (1k)
3	JUTRAS DAVID, QC (1D)

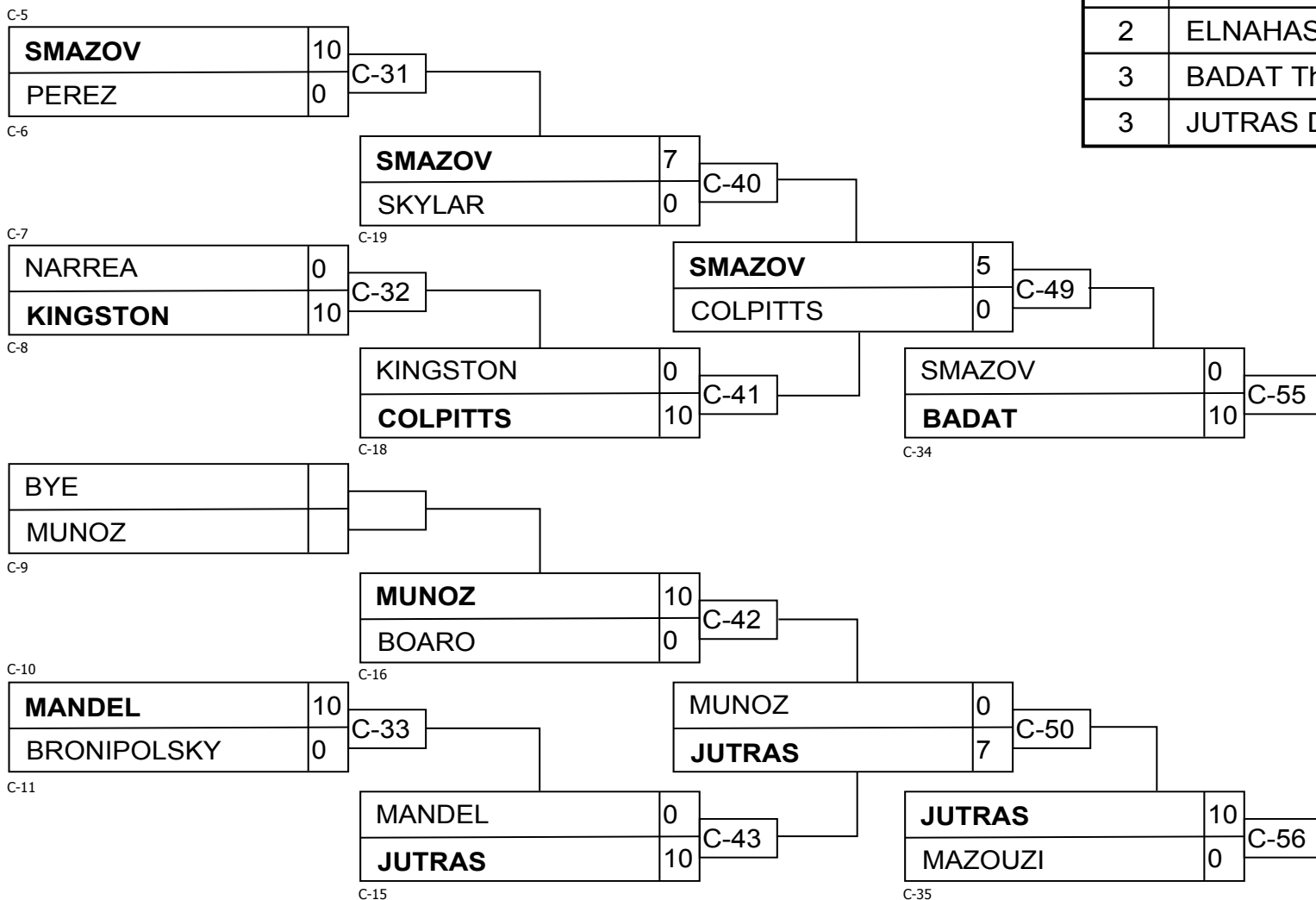

# SenM Open

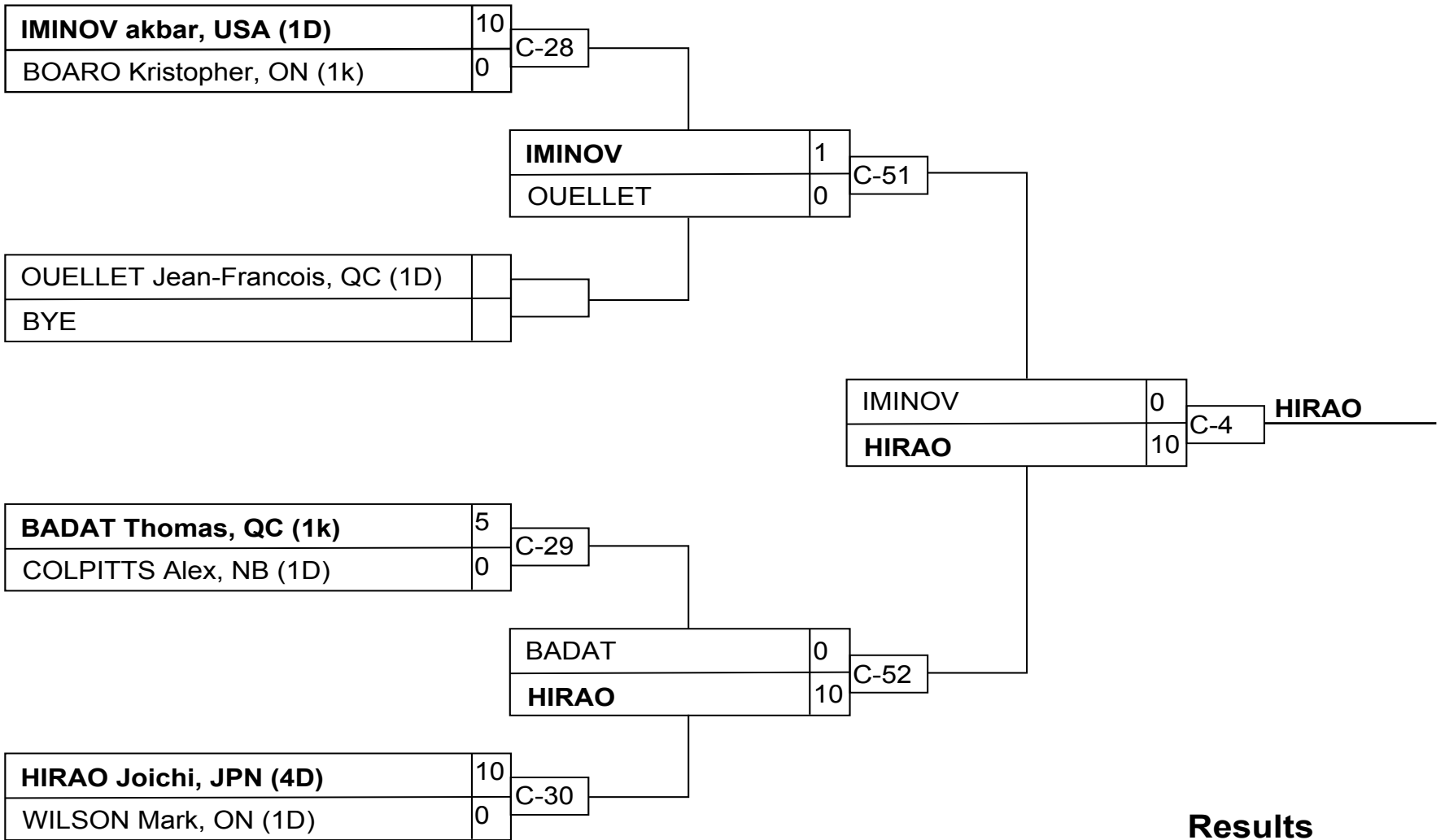

## Results

Pos	Name
1	HIRAO Joichi, JPN (4D)
2	IMINOV akbar, USA (1D)
3	OUELLET Jean-Francois, QC (1D)
3	BADAT Thomas, QC (1k)