

Omnium 2016 4-5 novembre 2016 Montréal U18F +70

Competitors: 3

Competitors

#	Name	Grade	Club	1	2	3	Wins	Pts	Pos
1	ARCHAMBAULT Audrey	2k	QC				0	0	3
2	WAHBA Maram	1k	QC	10			1	10	2
3	SYNOTT Josie-Anne	1k	QC	10	10		2	20	1

Matches

Match	White			Blue	Result	Time	Code
A-12	ARCHAMBAULT Audrey	1	2	WAHBA Maram	0 - 10	0:36	WIP
A-30	ARCHAMBAULT Audrey	1	3	SYNOTT Josie-Anne	0 - 10	2:19	IPO
A-59	WAHBA Maram	2	3	SYNOTT Josie-Anne	0 - 10	3:02	HAN

Results

Pos	Name
1	SYNOTT Josie-Anne, QC
2	WAHBA Maram, QC
3	ARCHAMBAULT Audrey, QC

Omnium 2016 4-5 novembre 2016 Montréal U18F -40

Competitors: 1

Competitors

#	Name	Grade	Club	1	Wins	Pts	Pos
1	SOMERS Andrée-Ann	1k	QC		0	0	1

Matches

Match	White	Blue	Result	Time	Code
-------	-------	------	--------	------	------

Results

Pos	Name
1	SOMERS Andrée-Ann, QC

Omnium 2016 4-5 novembre 2016 Montréal U18F -44

Competitors: 4

Competitors

#	Name	Grade	Club	1	2	3	4	Wins	Pts	Pos
1	TESANOVIC Ema	2k	AB		10	10	7	3	27	1
2	SOMERS Andrée-Ann	1k	QC			10		1	10	3
3	OUELLETTE Rebecca	1k	NB					0	0	4
4	ELICIA Lin	2k	ON		10	10		2	20	2

Matches

Match	White			Blue	Result	Time	Code
A-5	TESANOVIC Ema	1	2	SOMERS Andrée-Ann	10 - 0	2:44	IPO
A-14	OUELLETTE Rebecca	3	4	ELICIA Lin	0 - 10	1:51	HAN
A-23	TESANOVIC Ema	1	3	OUELLETTE Rebecca	10 - 0	2:21	IPO
A-32	SOMERS Andrée-Ann	2	4	ELICIA Lin	0 - 10	3:09	WIP
A-44	TESANOVIC Ema	1	4	ELICIA Lin	7 - 0	4:00	WAZ
A-61	SOMERS Andrée-Ann	2	3	OUELLETTE Rebecca	10 - 0	1:26	WIP

Results

Pos	Name
1	TESANOVIC Ema, AB
2	ELICIA Lin, ON
3	SOMERS Andrée-Ann, QC
4	OUELLETTE Rebecca, NB

U18F -48

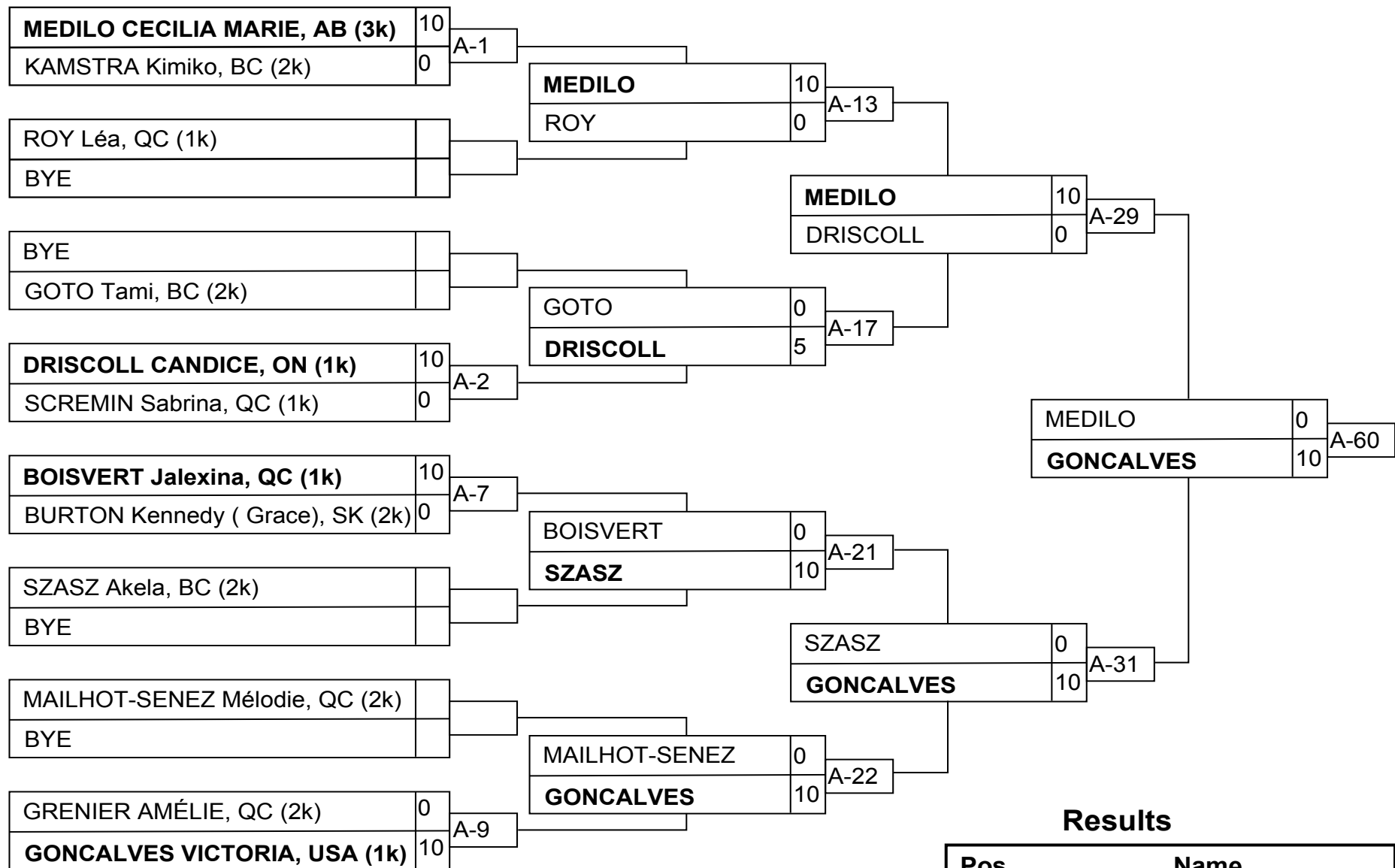

Results

Pos	Name
1	GONCALVES VICTORIA, USA (1k)
2	MEDILO CECILIA MARIE, AB (3k)
3	MAILHOT-SENEZ Mélodie, QC (2k)
3	SZASZ Akela, BC (2k)

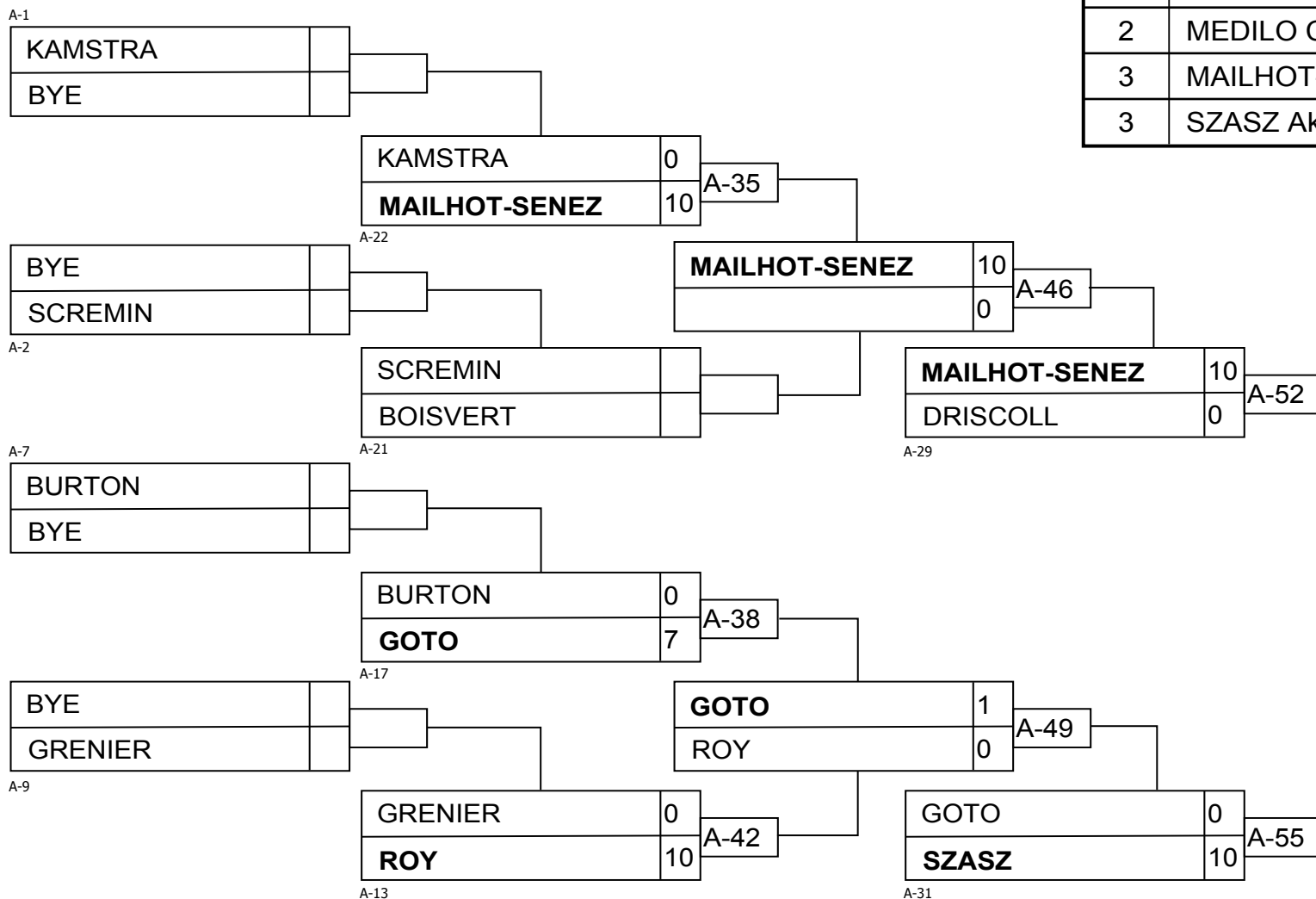

U18F -52

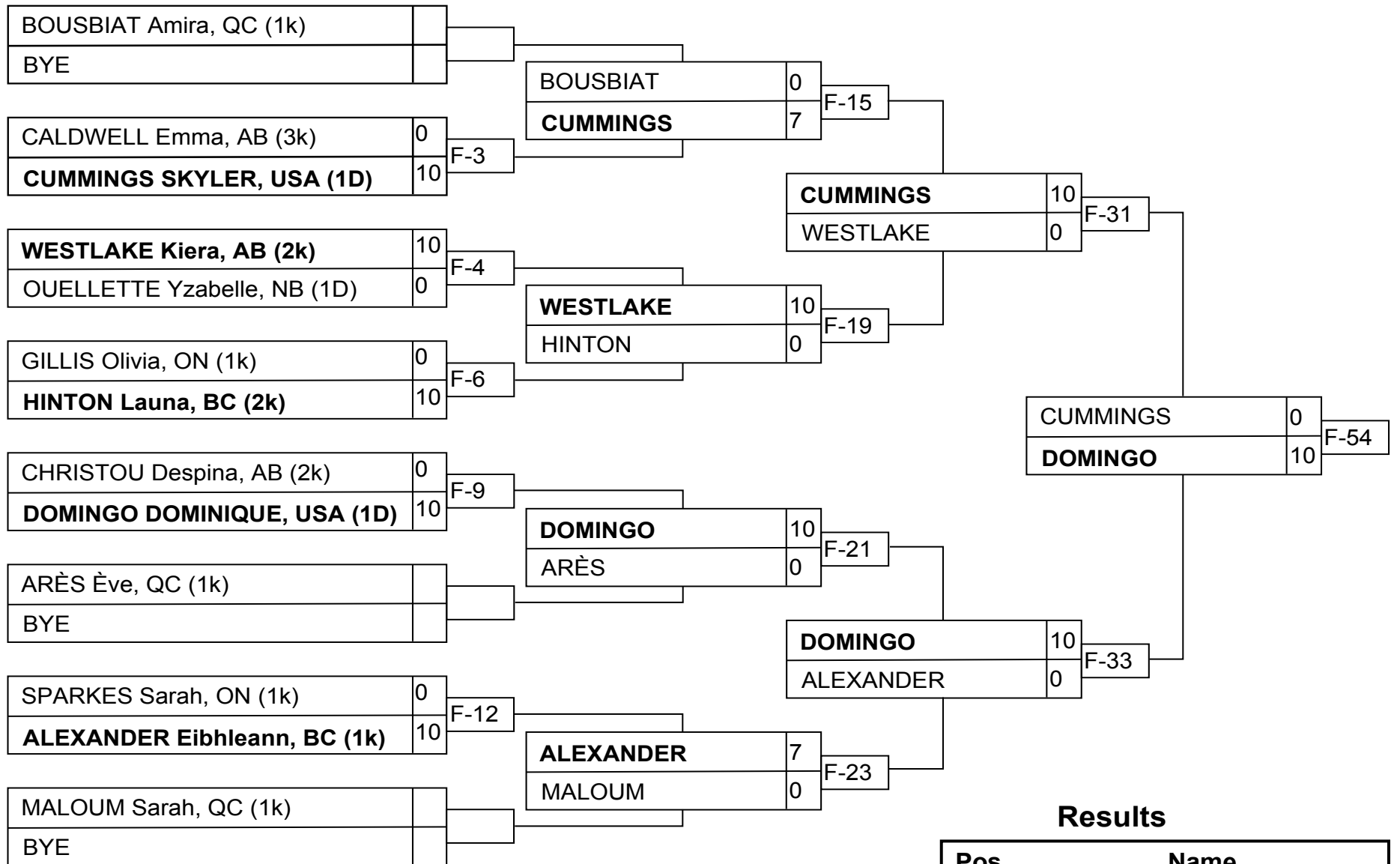

Results

Pos	Name
1	DOMINGO DOMINIQUE, USA (1D)
2	CUMMINGS SKYLER, USA (1D)
3	WESTLAKE Kiera, AB (2k)
3	ALEXANDER Eibhleann, BC (1k)

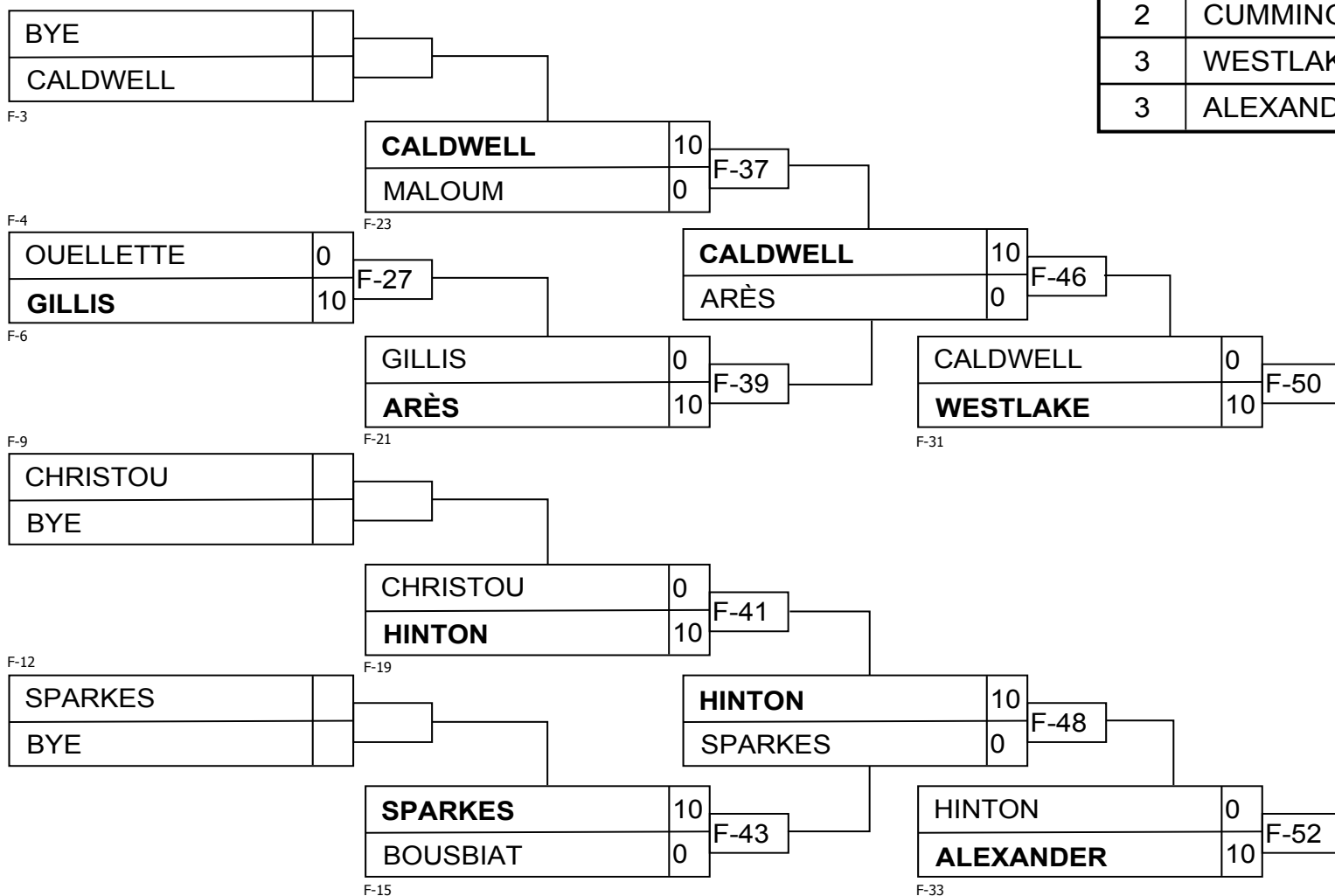

U18F -57

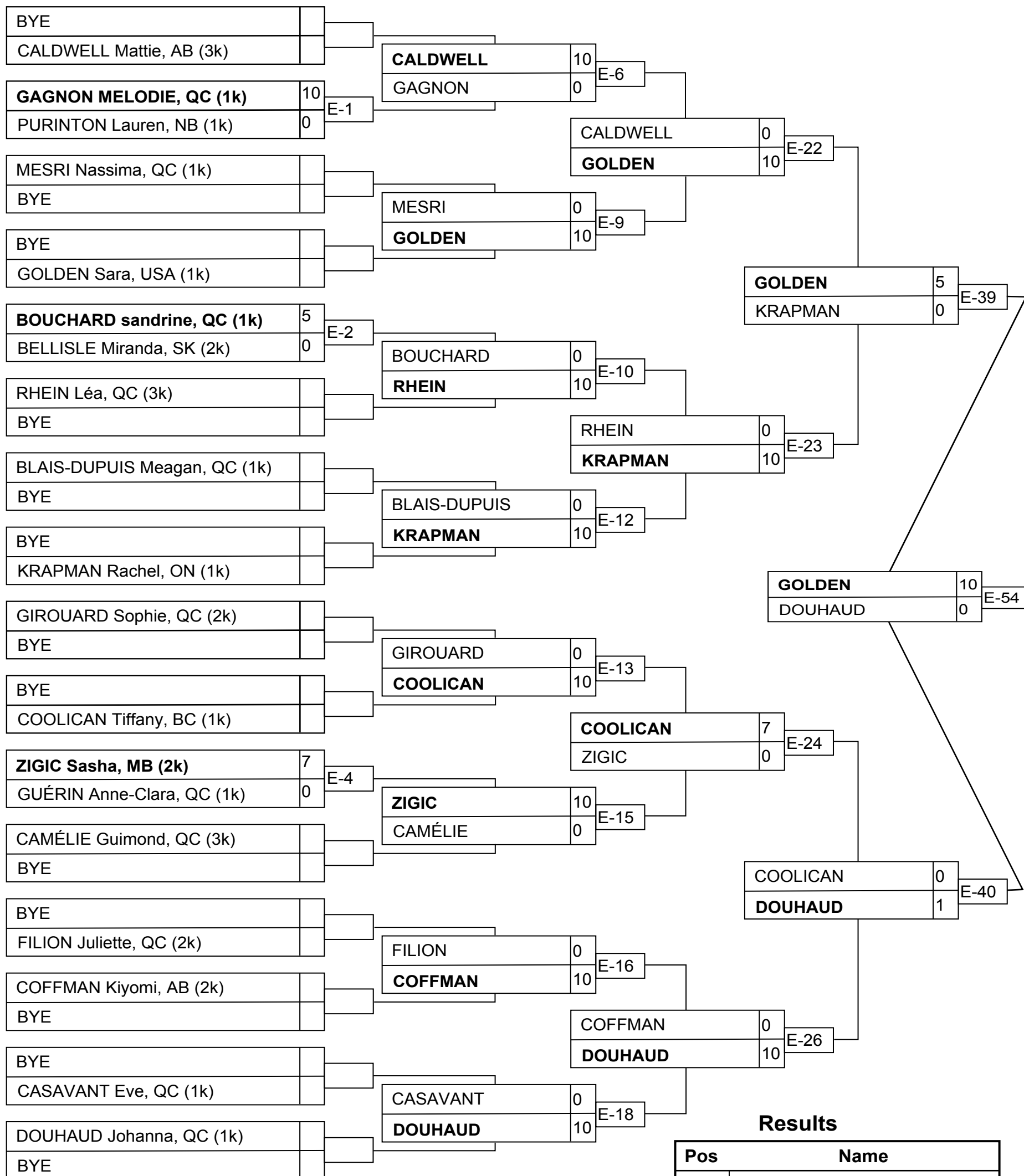

Results

Pos	Name
1	GOLDEN Sara, USA (1k)
2	DOUHAUD Johanna, QC (1k)
3	KRAPMAN Rachel, ON (1k)
3	COOLICAN Tiffany, BC (1k)

U18F -57

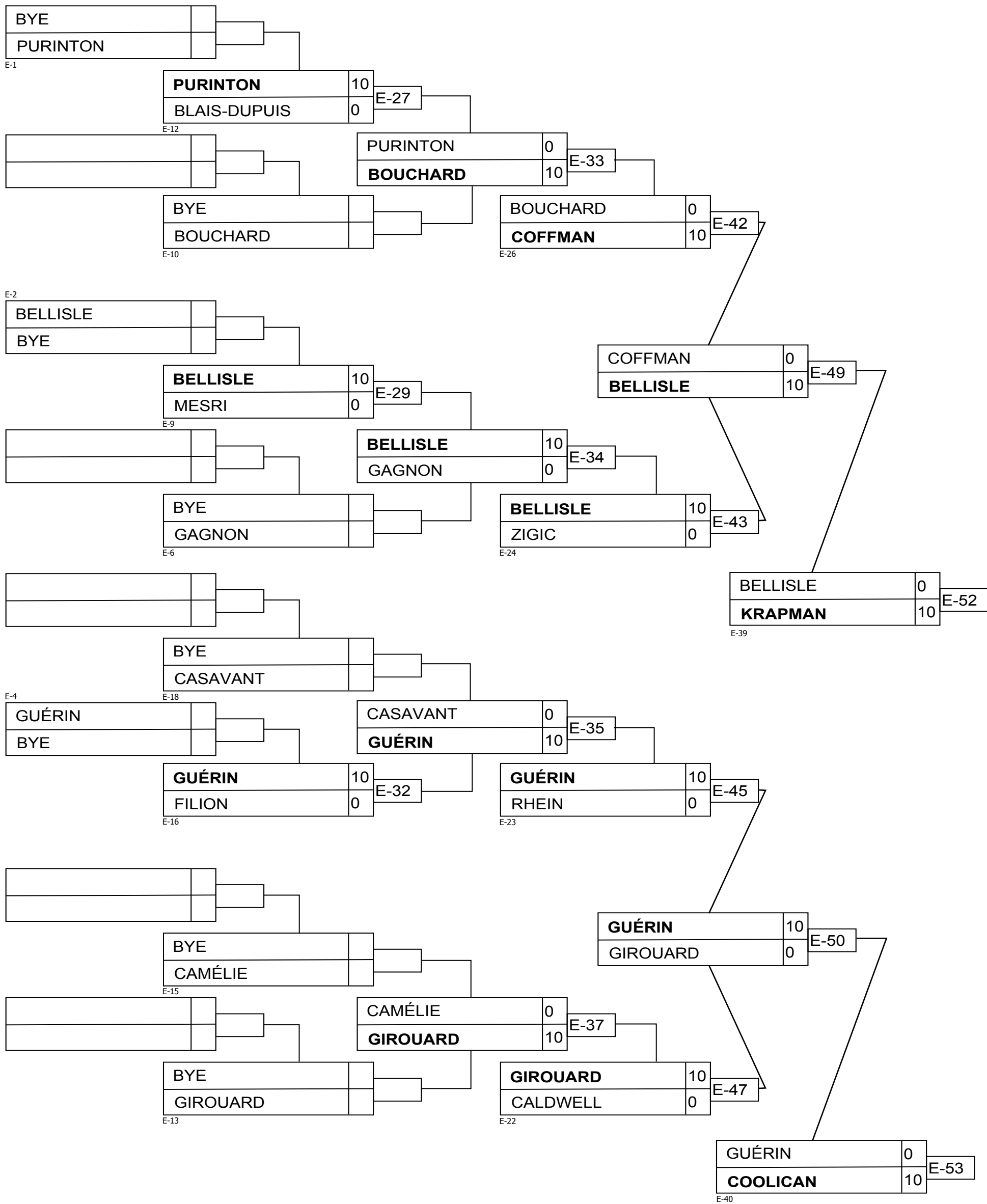

U18F -63

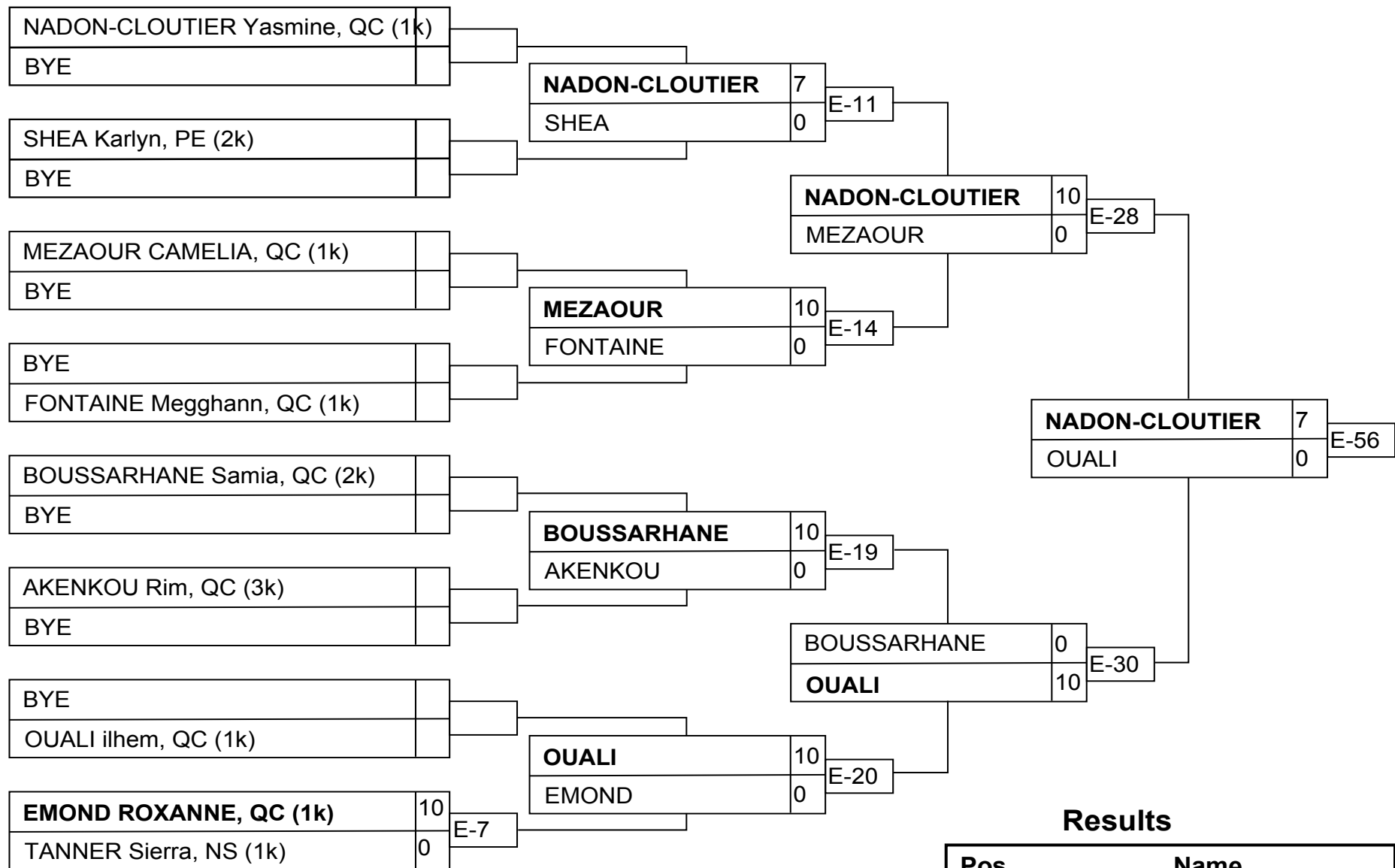

Results

Pos	Name
1	NADON-CLOUTIER Yasmine, QC (1k)
2	OUALI ilhem, QC (1k)
3	EMOND ROXANNE, QC (1k)
3	TANNER Sierra, NS (1k)

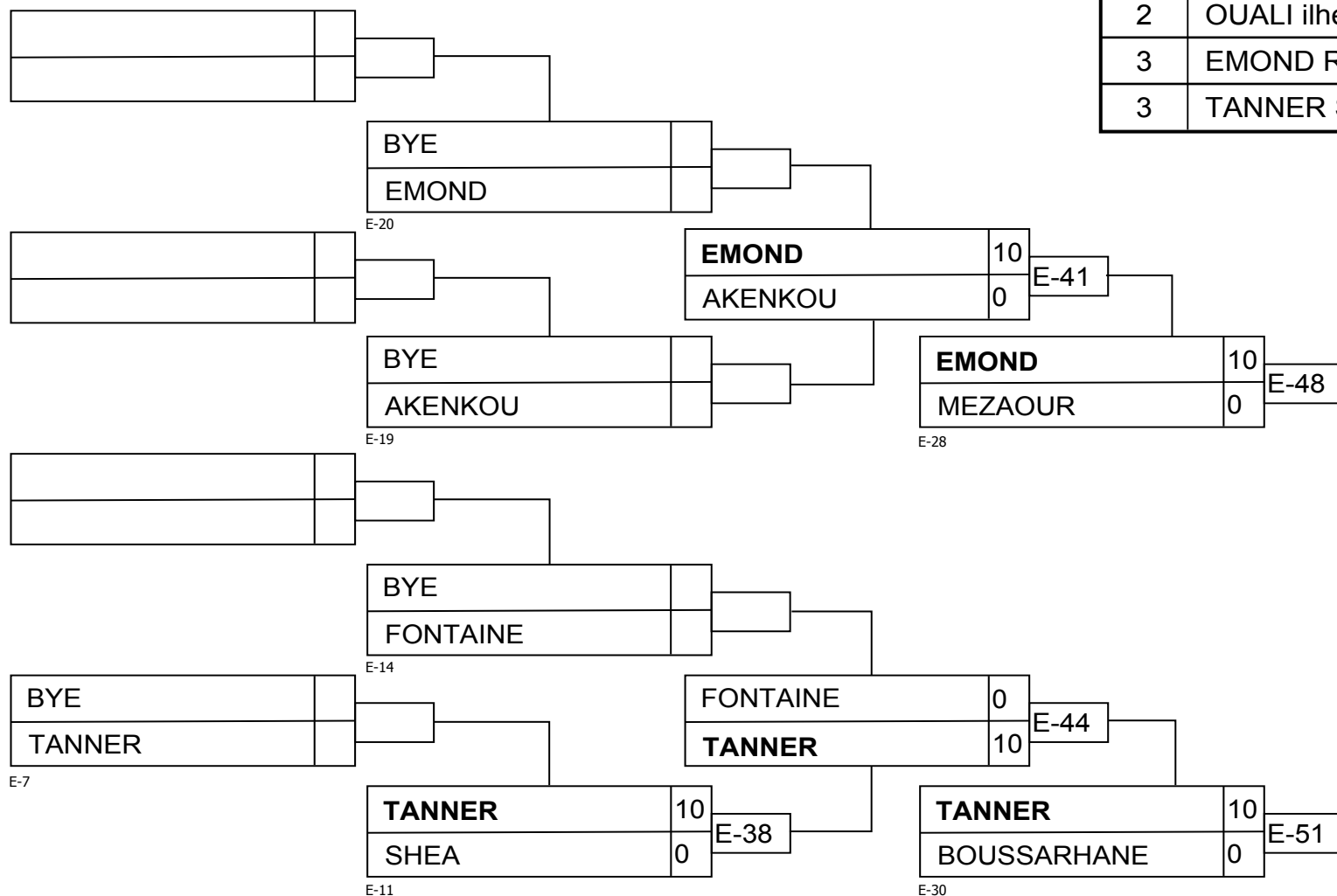

Omnium 2016 4-5 novembre 2016 Montréal U18F -70

Competitors: 4

Competitors

#	Name	Grade	Club	1	2	3	4	Wins	Pts	Pos
1	RANDRIANAHINORO Naomi	1k	QC					0	0	4
2	GODBOUT Coralie	2k	QC	10		10		2	20	2
3	VENUGOPAL Madison	1D	ON	10				1	10	3
4	MARTIN Maria	2k	SK	10	10	10		3	30	1

Matches

Match	White			Blue	Result	Time	Code
F-8	RANDRIANAHINORO Naomi	1	2	GODBOUT Coralie	0 - 10	3:42	IPO
F-18	VENUGOPAL Madison	3	4	MARTIN Maria	0 - 10	1:04	IPO
F-26	RANDRIANAHINORO Naomi	1	3	VENUGOPAL Madison	0 - 10	1:28	IPO
F-36	GODBOUT Coralie	2	4	MARTIN Maria	0 - 10	0:33	IPO
F-45	RANDRIANAHINORO Naomi	1	4	MARTIN Maria	0 - 10	1:13	WIP
F-57	GODBOUT Coralie	2	3	VENUGOPAL Madison	10 - 0	2:31	IPO

Results

Pos	Name
1	MARTIN Maria, SK
2	GODBOUT Coralie, QC
3	VENUGOPAL Madison, ON
4	RANDRIANAHINORO Naomi, QC

Omnium 2016 4-5 novembre 2016 Montréal U18M +90

Competitors: 2

Competitors

#	Name	Grade	Club	1	2	1	2	1	2	Wins	Pts	Pos
1	ELLIOT Wilson	2k	NT				10			1	10	2
2	COUTU Xavier	1k	QC	7				1		2	8	1

Matches

Match	White			Blue	Result	Time	Code
D-18	ELLIOT Wilson	1	2	COUTU Xavier	0 - 7	4:00	WAZ
D-37	ELLIOT Wilson	1	2	COUTU Xavier	10 - 0	3:16	WIP
D-58	ELLIOT Wilson	1	2	COUTU Xavier	0 - 1	4:00	YUS

Results

Pos	Name
1	COUTU Xavier, QC
2	ELLIOT Wilson, NT

Omnium 2016 4-5 novembre 2016 Montréal U18M -46

Competitors: 3

Competitors

#	Name	Grade	Club	1	2	3	Wins	Pts	Pos
1	GARSON Max	2k	QC		7	10	2	17	1
2	PAQUET Simon	1k	QC			10	1	10	2
3	NORQUAY Graham	3k	BC				0	0	3

Matches

Match	White			Blue	Result	Time	Code
F-17	GARSON Max	1	2	PAQUET Simon	7 - 0	5:00	GSW
F-35	GARSON Max	1	3	NORQUAY Graham	10 - 0	3:11	WIP
F-56	PAQUET Simon	2	3	NORQUAY Graham	10 - 0	0:30	IPO

Results

Pos	Name
1	GARSON Max, QC
2	PAQUET Simon, QC
3	NORQUAY Graham, BC

Omnium 2016 4-5 novembre 2016 Montréal U18M -50

Competitors: 5

Competitors

#	Name	Grade	Club	1	2	3	4	5	Wins	Pts	Pos
1	TREMBLAY JUSTIN	1k	QC		10	5			2	15	3
2	DESBIENS Jacob	1k	QC						0	0	5
3	DECLAN Harding	1k	AB		10				1	10	4
4	DROLET Émile	1k	QC	10	10	5			3	25	2
5	BLACKIÈRE Arno	1k	QC	5	10	10	1		4	26	1

Matches

Match	White			Blue	Result	Time	Code
E-3	DROLET Émile	4	5	BLACKIÈRE Arno	0 - 1	4:00	YUS
E-5	TREMBLAY JUSTIN	1	2	DESBIENS Jacob	10 - 0	1:15	IPO
E-8	DECLAN Harding	3	4	DROLET Émile	0 - 5	4:00	YUK
E-17	TREMBLAY JUSTIN	1	5	BLACKIÈRE Arno	0 - 5	4:00	YUK
E-21	DESBIENS Jacob	2	3	DECLAN Harding	0 - 10	1:50	IPO
E-25	TREMBLAY JUSTIN	1	4	DROLET Émile	0 - 10	0:34	IPO
E-31	DECLAN Harding	3	5	BLACKIÈRE Arno	0 - 10	3:06	IPO
E-36	DESBIENS Jacob	2	4	DROLET Émile	0 - 10	1:30	IPO
E-46	TREMBLAY JUSTIN	1	3	DECLAN Harding	5 - 0	4:00	YUK
E-55	DESBIENS Jacob	2	5	BLACKIÈRE Arno	0 - 10	1:04	IPO

Results

Pos	Name
1	BLACKIÈRE Arno, QC
2	DROLET Émile, QC
3	TREMBLAY JUSTIN, QC
4	DECLAN Harding, AB
5	DESBIENS Jacob, QC

U18M -55

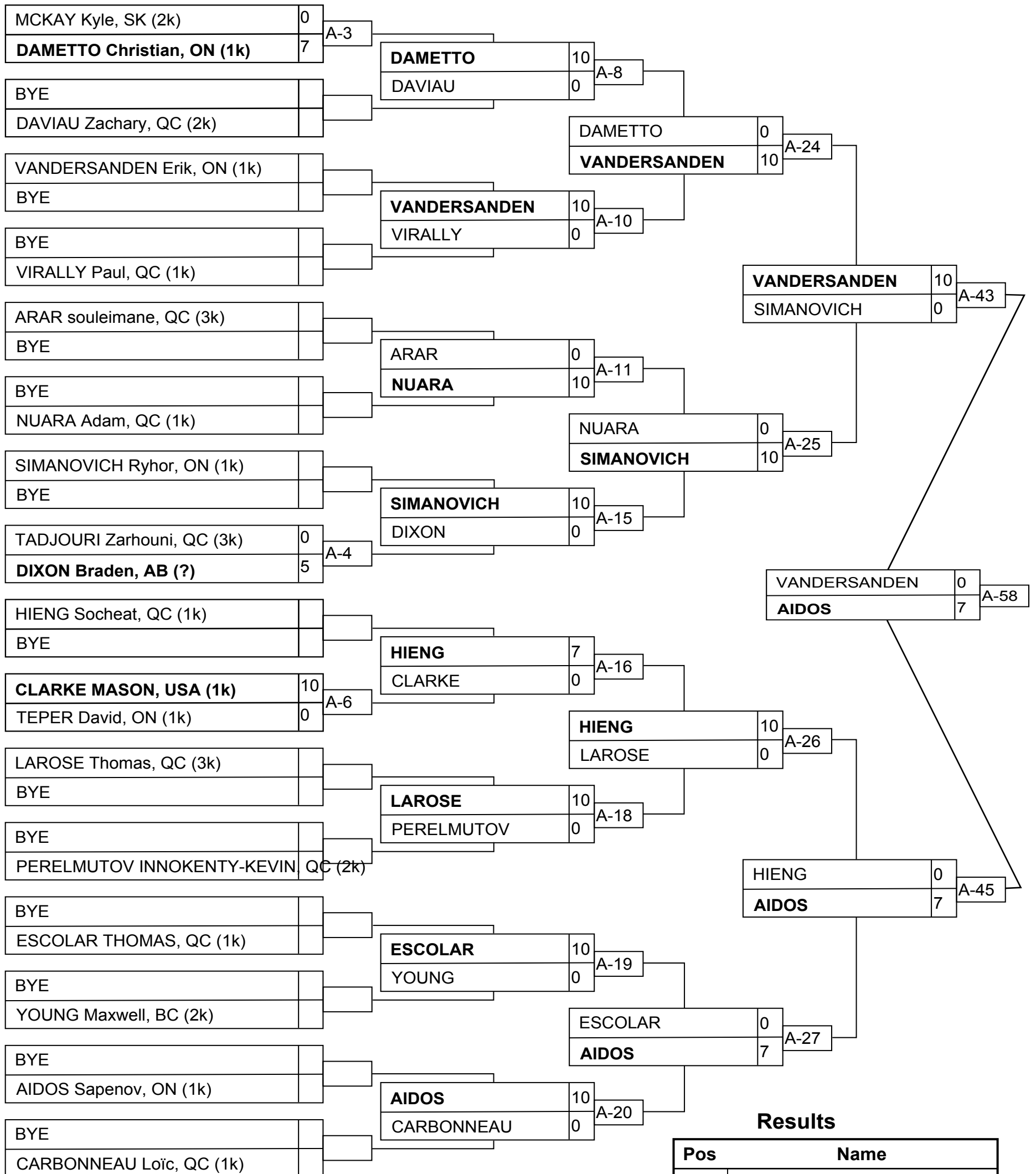

Results

Pos	Name
1	AIDOS Sapenov, ON (1k)
2	VANDERSANDEN Erik, ON (1k)
3	SIMANOVICH Ryhor, ON (1k)
3	CLARKE MASON, USA (1k)

U18M -55

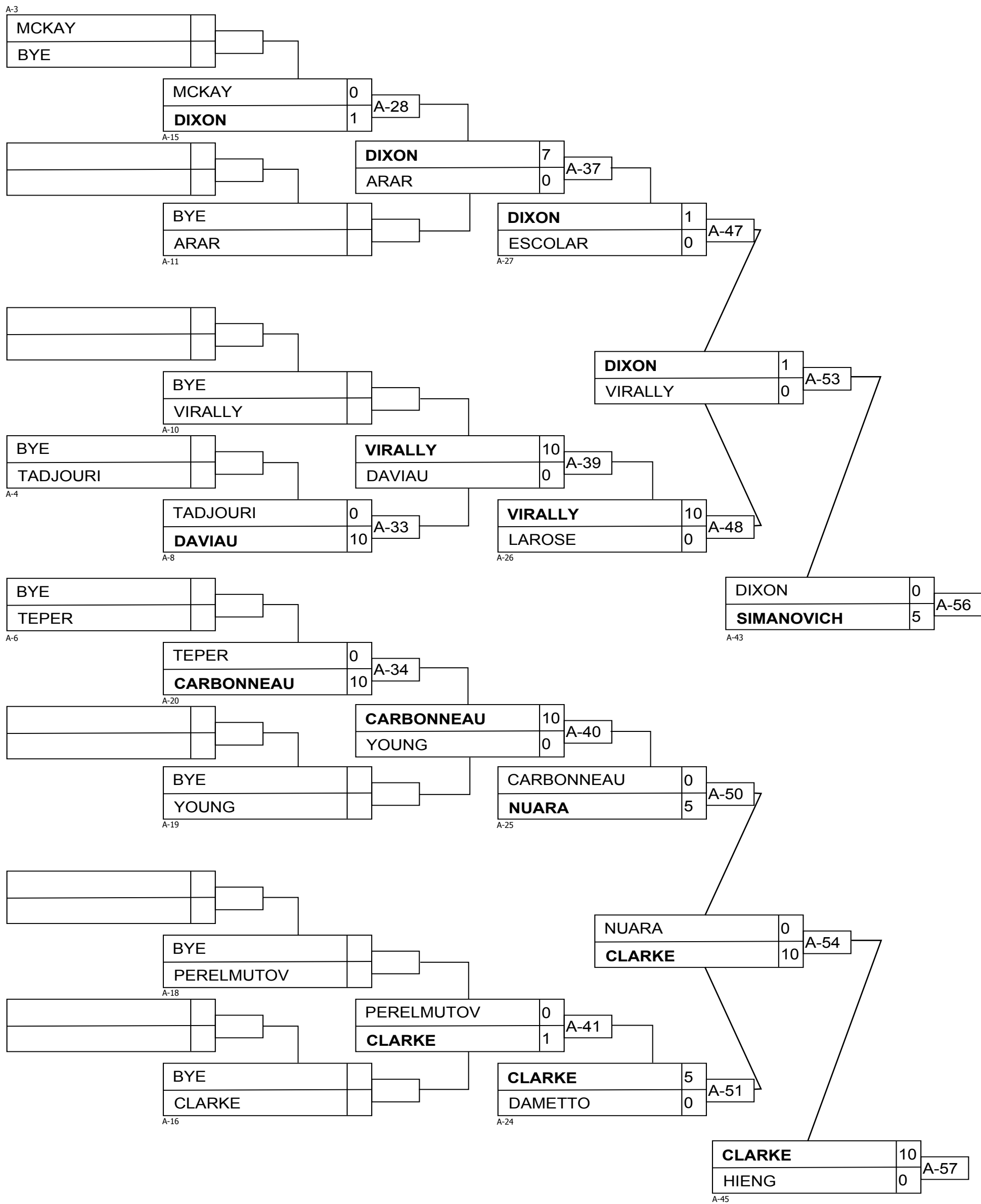

U18M -60

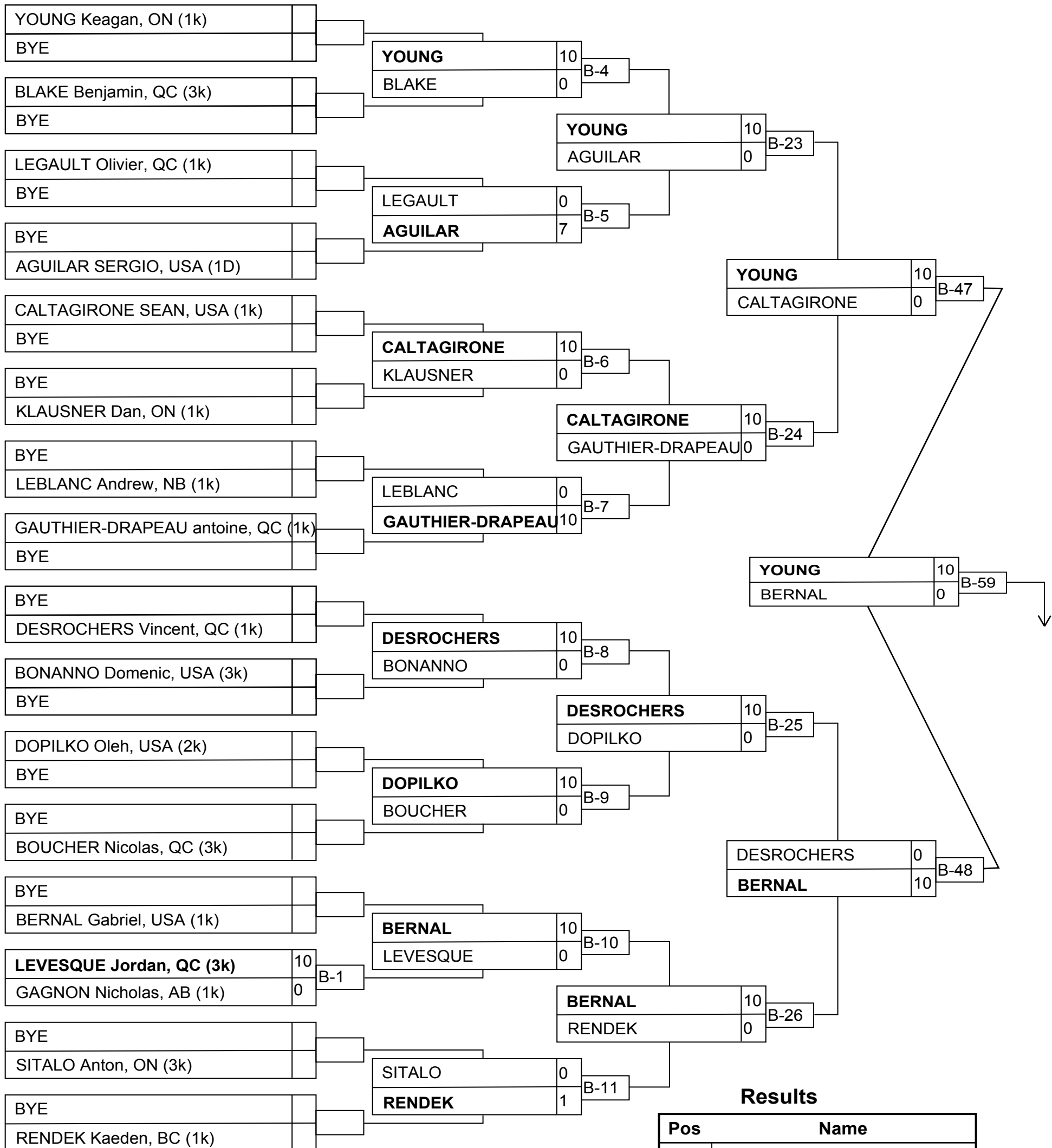

Results

Pos	Name
1	YOUNG Keagan, ON (1k)
2	ALKHATIB ismail, QC (1k)
3	JORA Bogdan, QC (1k)
3	CALTAGIRONE SEAN, USA (1k)

U18M -60

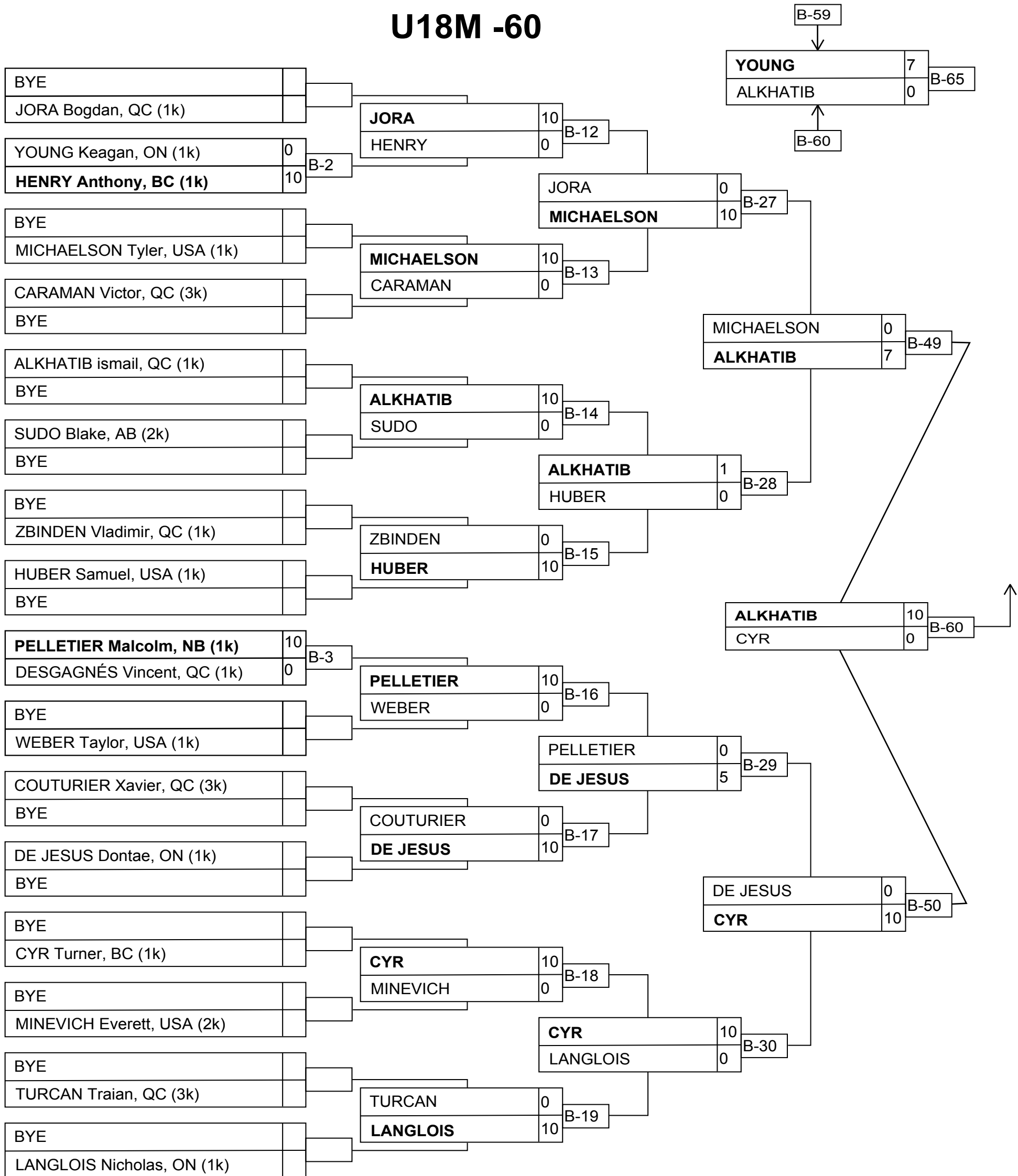

U18M-60

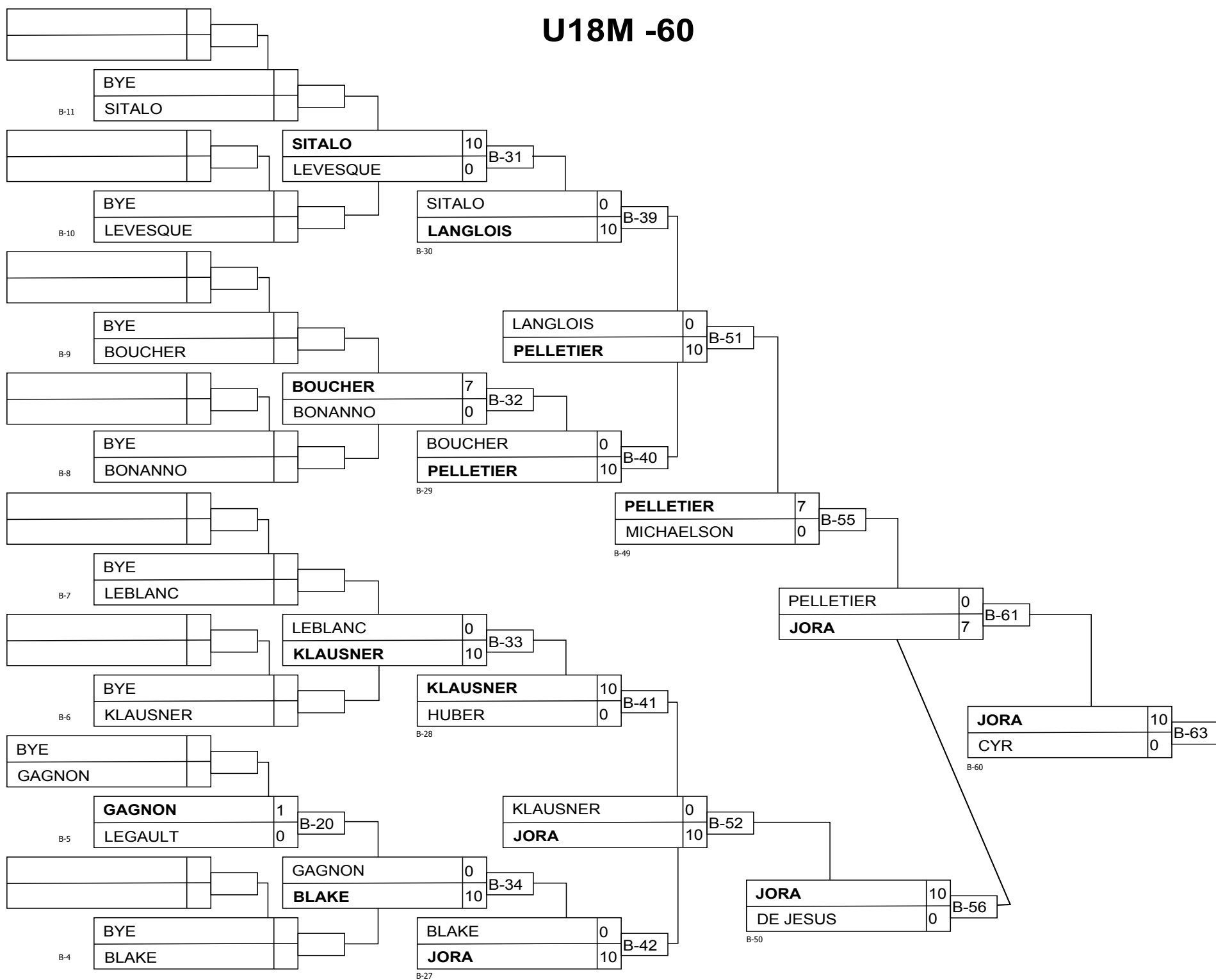

U18M-60

B-2

BYE	
YOUNG	

YOUNG	0
TURCAN	10

B-21

TURCAN	7
MINEVICH	0

B-35

BYE	
MINEVICH	

B-26

TURCAN	0
RENDEK	10

B-43

BYE	
COUTURIER	

B-17

RENDEK	0
DOPIILKO	1

B-53

COUTURIER	0
WEBER	10

B-36

BYE	
WEBER	

B-16

WEBER	0
DOPIILKO	5

B-44

B-25

B-3

DESGAGNÉS	
BYE	

DESGAGNÉS	10
ZBINDEN	0

B-15

B-22

DESGAGNÉS	0
SUDO	5

B-37

BYE	
SUDO	

B-14

SUDO	0
GAUTHIER-DRAPEAU	10

B-45

B-24

BYE	
CARAMAN	

B-13

GAUTHIER-DRAPEAU	0
HENRY	1

B-54

CARAMAN	0
HENRY	10

B-38

BYE	
HENRY	

B-12

HENRY	10
AGUILAR	0

B-46

B-23

B-47

DOPIILKO	0
CALTAGIRONE	10

B-57

CALTAGIRONE	10
DESROCHERS	0

B-62

CALTAGIRONE	7
BERNAL	0

B-64

B-59

HENRY	0
DESROCHERS	10

B-48

B-58

U18M -66

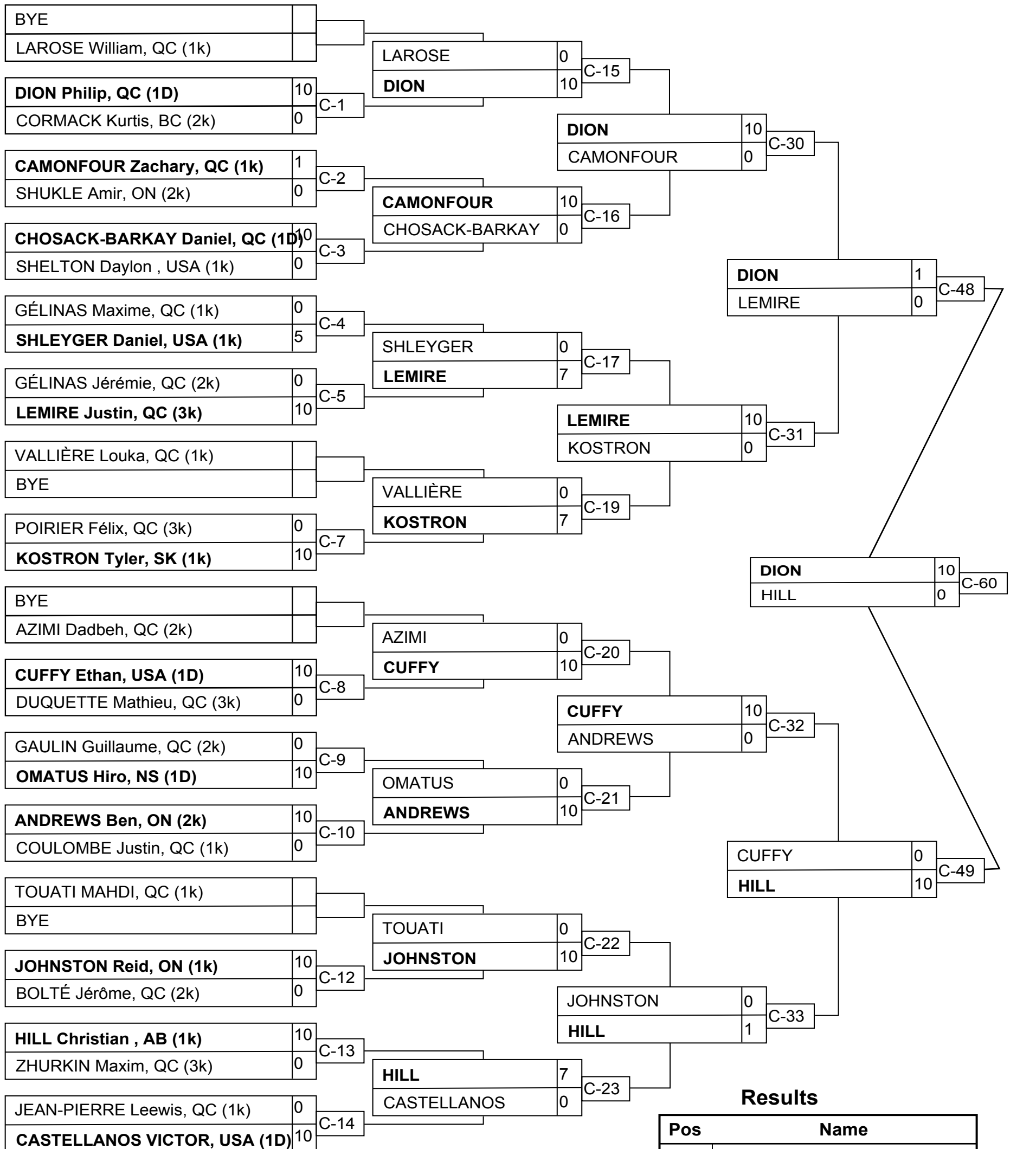

U18M -66

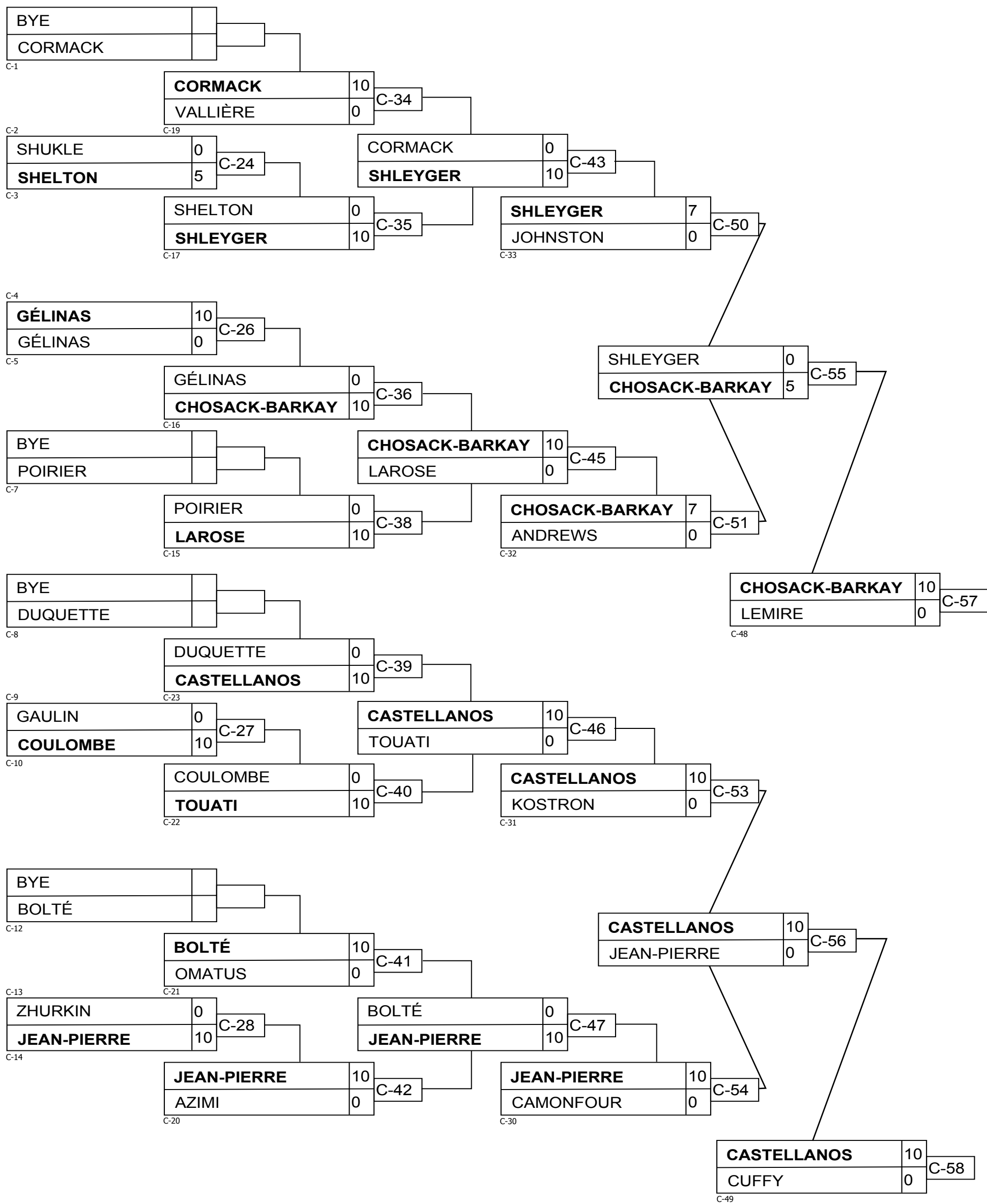

U18M -73

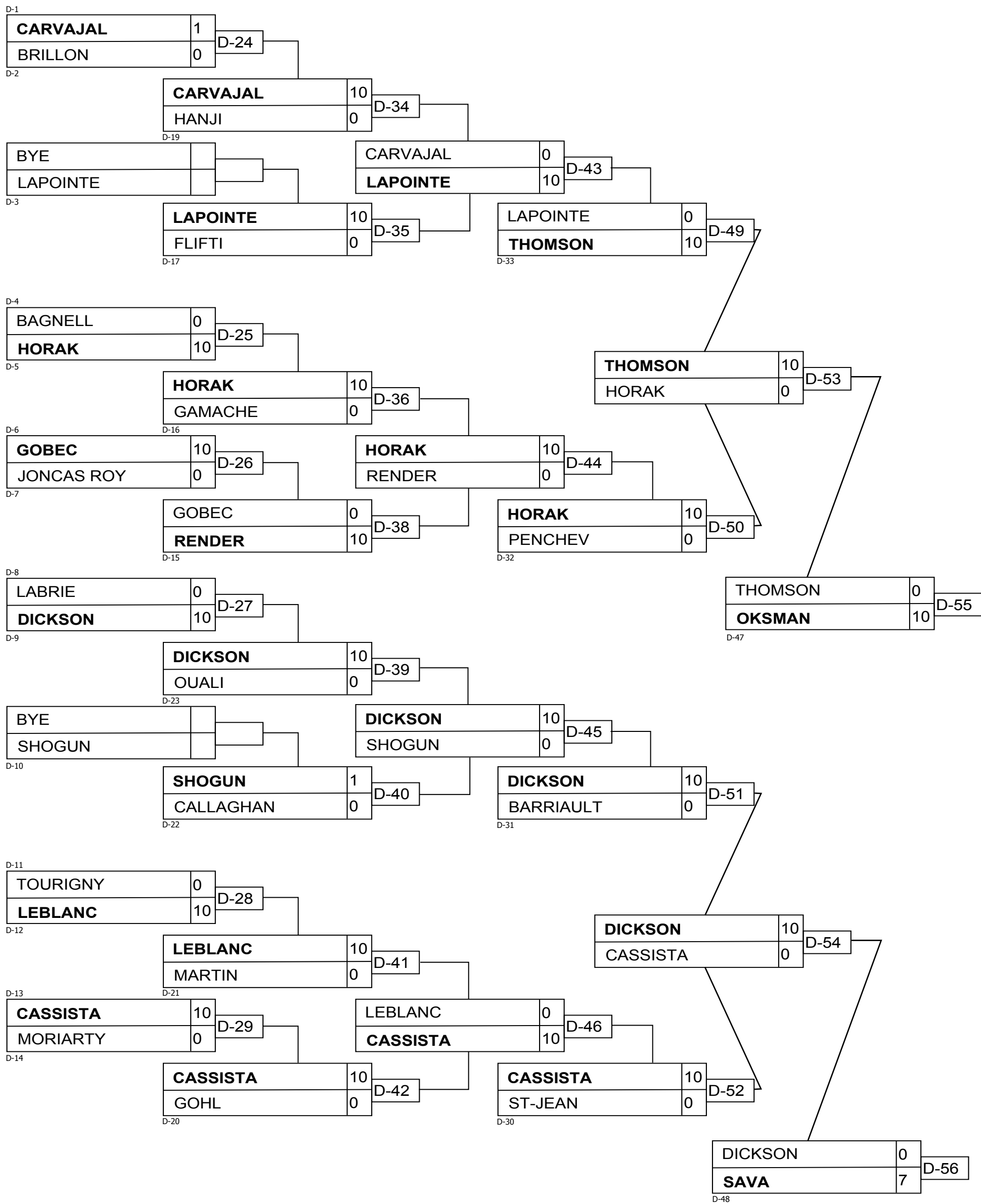

U18M -81

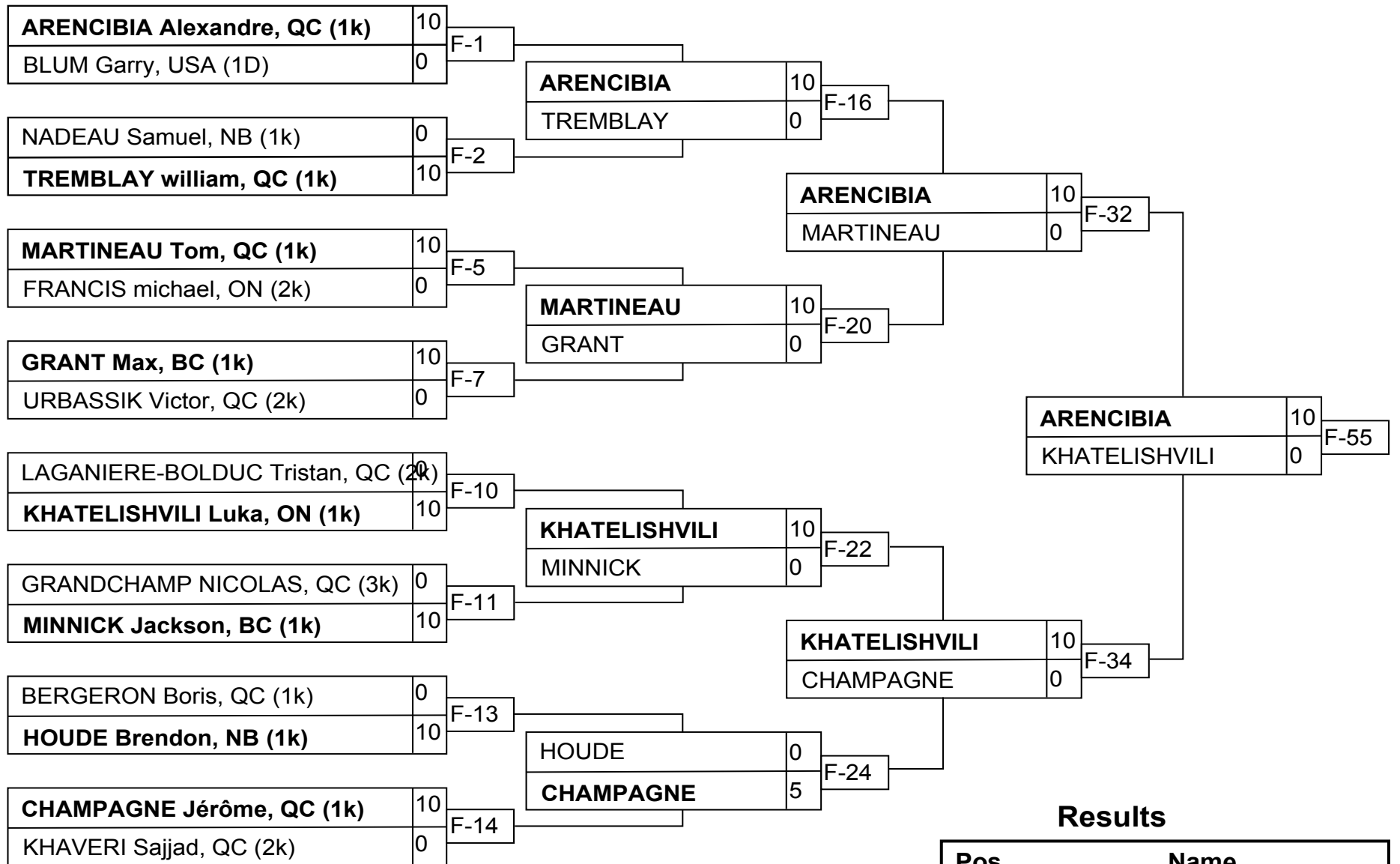

Results

Pos	Name
1	ARENCIBIA Alexandre, QC (1k)
2	KHATELISHVILI Luka, ON (1k)
3	MINNICK Jackson, BC (1k)
3	GRANT Max, BC (1k)

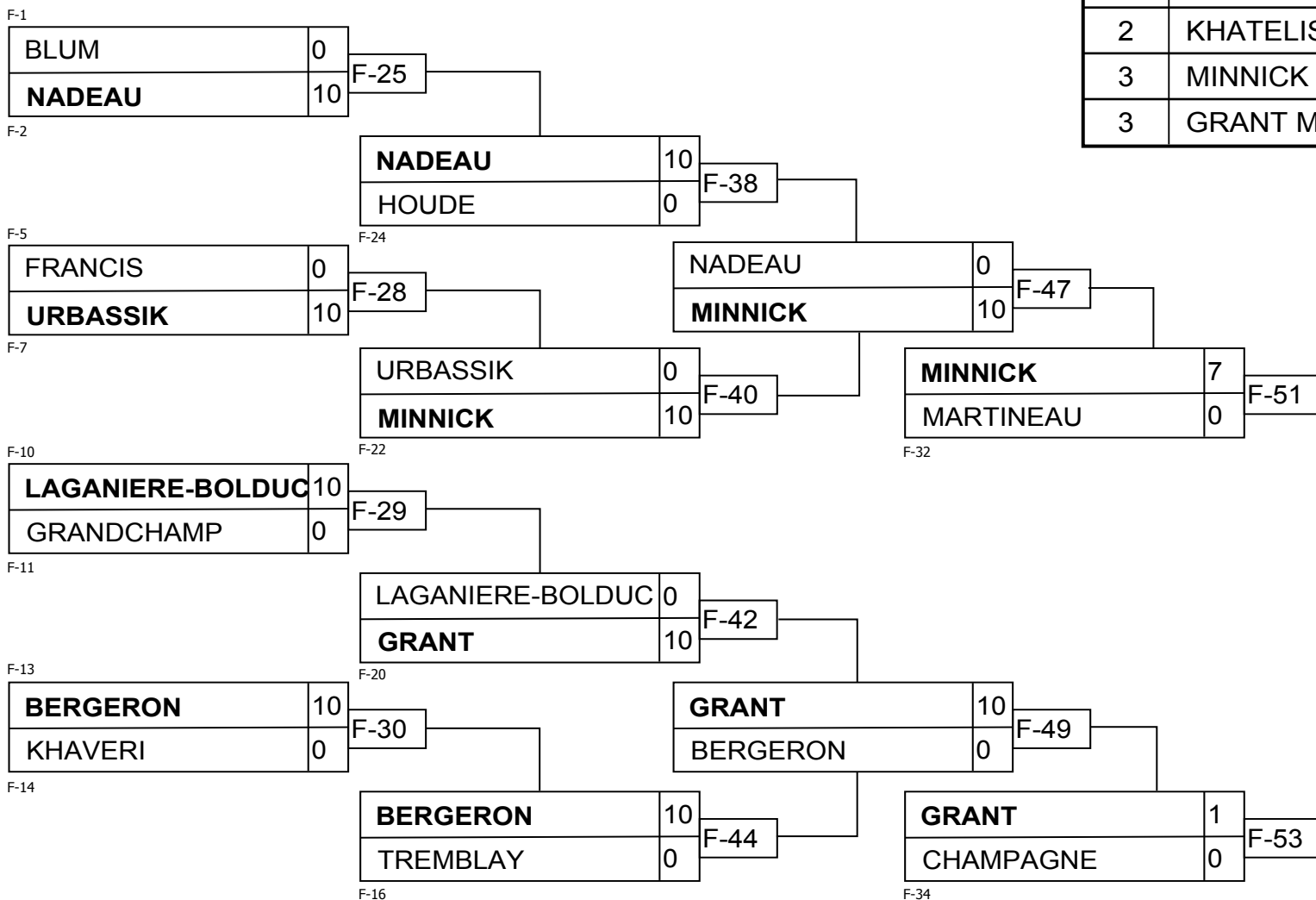

Omniium 2016 4-5 novembre 2016 Montréal U18M -90

Competitors: 6

Competitors A

#	Name	Grade	Club	1	2	3	Wins	Pts	Pos
1	LEVESQUE Nicolas	3k+	QC				0	0	3
2	MELANSON Shayne	1k	YT	10		10	2	20	1
3	HENNEBURY Alex	3k	NS	10			1	10	2

Matches A

Match	White	Blue	Result	Time	Code
C-6	LEVESQUE Nicolas 1 2	MELANSON Shayne	0 - 10	0:38	IPO
C-18	LEVESQUE Nicolas 1 3	HENNEBURY Alex	0 - 10	1:17	IPO
C-29	MELANSON Shayne 2 3	HENNEBURY Alex	10 - 0	1:05	IPO

Competitors B

#	Name	Grade	Club	4	5	6	Wins	Pts	Pos
4	SEYE Norman	2k	QC				0	0	3
5	RYDER Ian	1k	BC	10		10	2	20	1
6	BECKER Rayleigh	1k	ON	10			1	10	2

Matches B

Match	White	Blue	Result	Time	Code
C-11	SEYE Norman 4 5	RYDER Ian	0 - 10	0:13	IPO
C-25	SEYE Norman 4 6	BECKER Rayleigh	0 - 10	0:55	WIP
C-37	RYDER Ian 5 6	BECKER Rayleigh	10 - 0	3:19	IPO

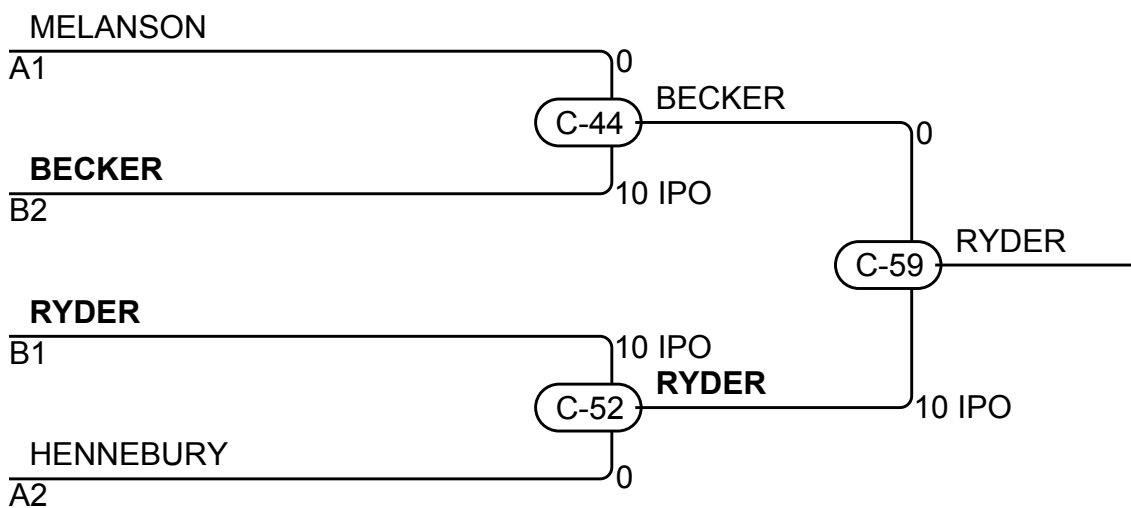

Results

Pos	Name
1	RYDER Ian, BC
2	BECKER Rayleigh, ON
3	MELANSON Shayne, YT
3	HENNEBURY Alex, NS