

# Omnium 2016 4-5 novembre 2016 Montréal FO U21 F -57G

Compétiteurs/Competitors: 2

## Compétiteurs/Competitors

#	Nom/Name	Grade	Club	1	2	G/W	Pts	Pos
1	PITSILIS Camélia	1D	QC		10	1	10	1
2	THIVIERGE Gabrielle	1D	QC			0	0	2

## Matches/Matches

Match	Blanc/White			Bleu/Blue	Rés/Res	Tmp/Tim	Code
1	PITSILIS Camélia	1	2	THIVIERGE Gabrielle	10 - 0	0:36	IPO

## Résultats/Results

Pos	Nom/Name
1	PITSILIS Camélia, QC
2	THIVIERGE Gabrielle , QC

# Omnium 2016 4-5 novembre 2016 Montréal U21F +78

Compétiteurs/Competitors: 1

## Compétiteurs/Competitors

#	Nom/Name	Grade	Club	1	G/W	Pts	Pos
1	DARLOW Annabelle	2k	AB		0	0	1

## Matches/Matches

Match	Blanc/White	Bleu/Blue	Rés/Res	Tmp/Tim	Code
-------	-------------	-----------	---------	---------	------

## Résultats/Results

Pos	Nom/Name
1	DARLOW Annabelle, AB

# Omnium 2016 4-5 novembre 2016 Montréal U21F -44

Compétiteurs/Competitors: 1

## Compétiteurs/Competitors

#	Nom/Name	Grade	Club	1	G/W	Pts	Pos
1	SOMERS Andrée-Ann	1k	QC		0	0	1

## Matches/Matches

Match	Blanc/White	Bleu/Blue	Rés/Res	Tmp/Tim	Code
-------	-------------	-----------	---------	---------	------

## Résultats/Results

Pos	Nom/Name
1	SOMERS Andrée-Ann, QC

# U21F -48

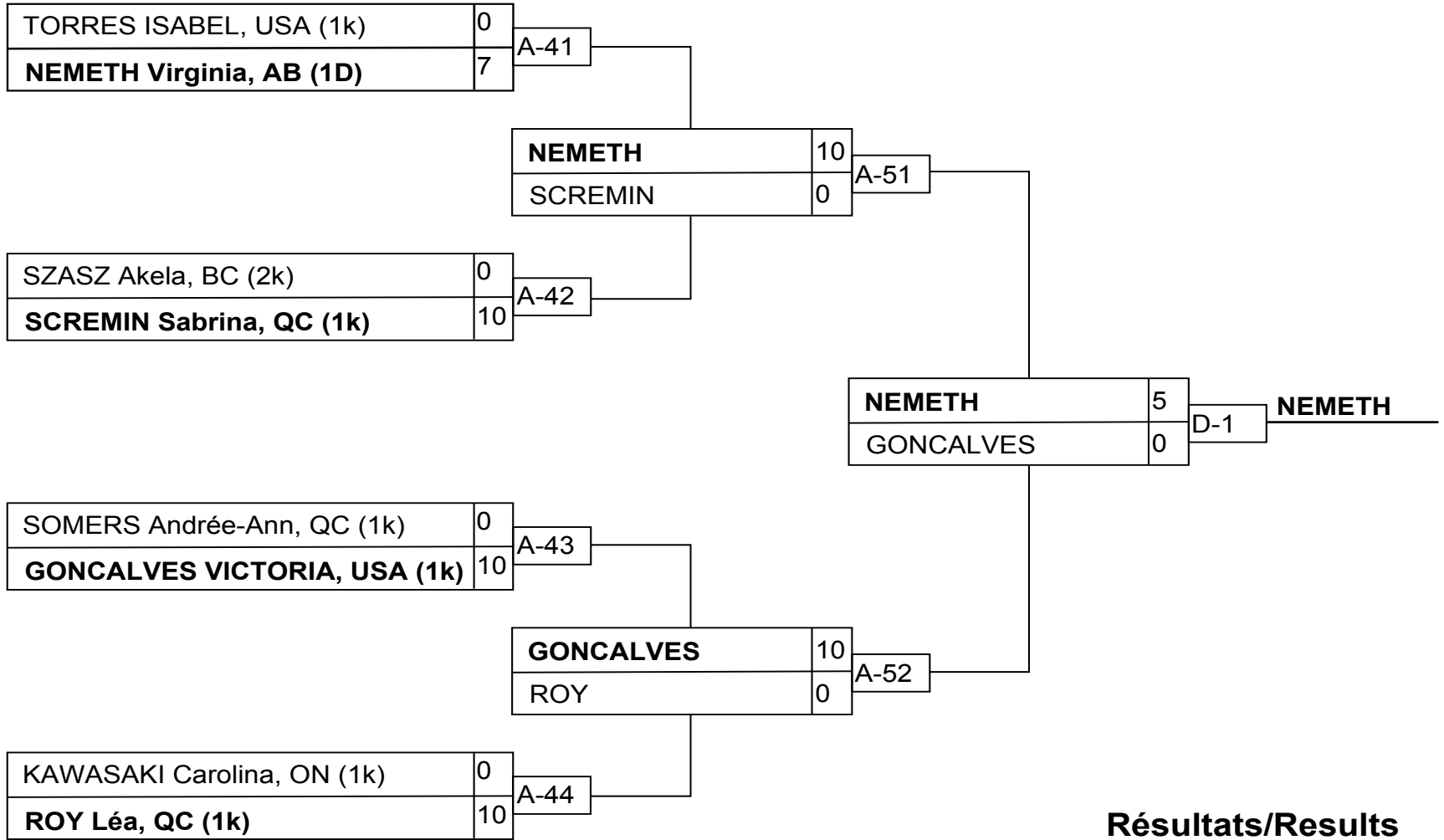

## Résultats/Results

Pos	Nom/Name
1	NEMETH Virginia, AB (1D)
2	GONCALVES VICTORIA, USA (1k)
3	KAWASAKI Carolina, ON (1k)
3	ROY Léa, QC (1k)

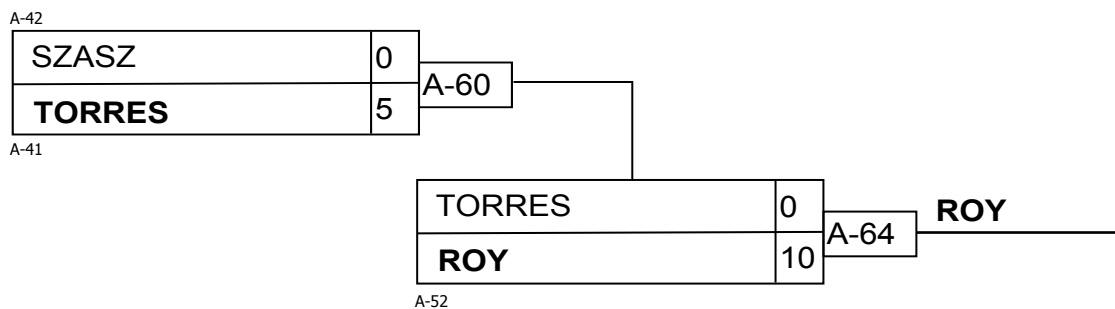
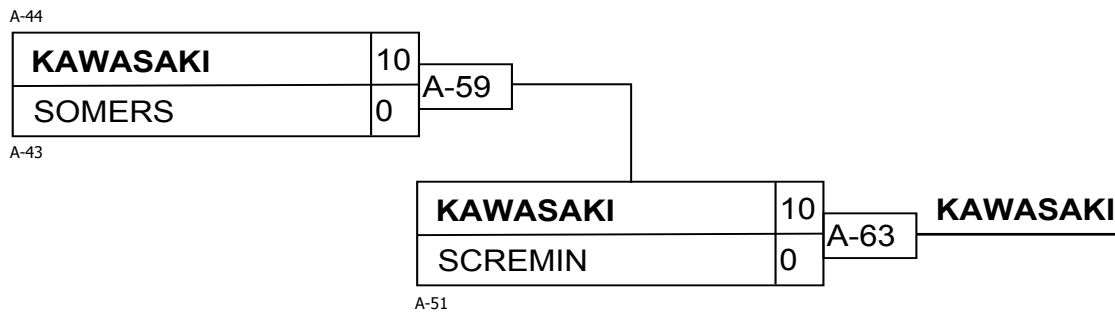

# U21F -52

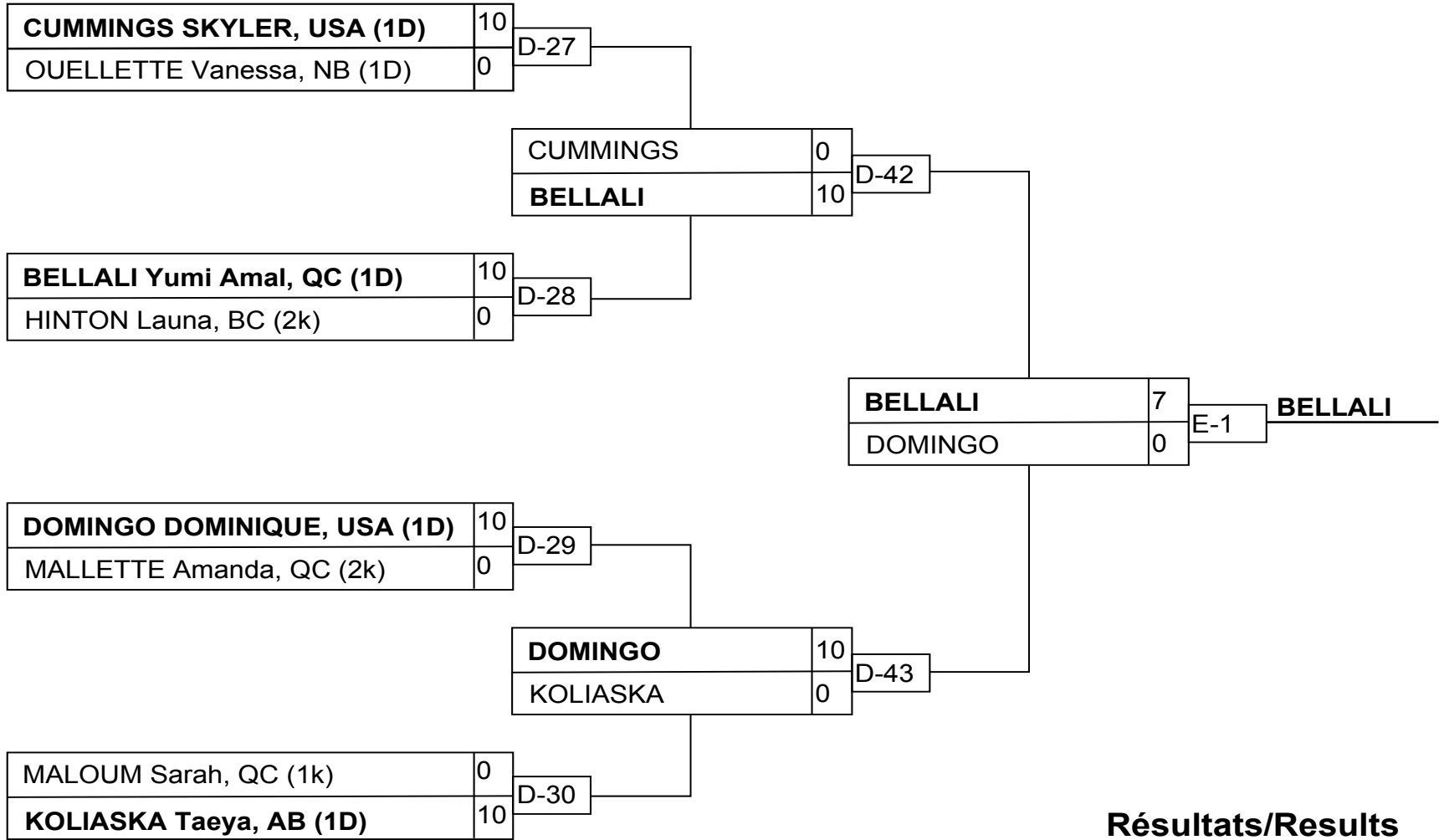

## Résultats/Results

Pos	Nom/Name
1	BELLALI Yumi Amal, QC (1D)
2	DOMINGO DOMINIQUE, USA (1D)
3	CUMMINGS SKYLER, USA (1D)
3	KOLIASKA Taeya, AB (1D)

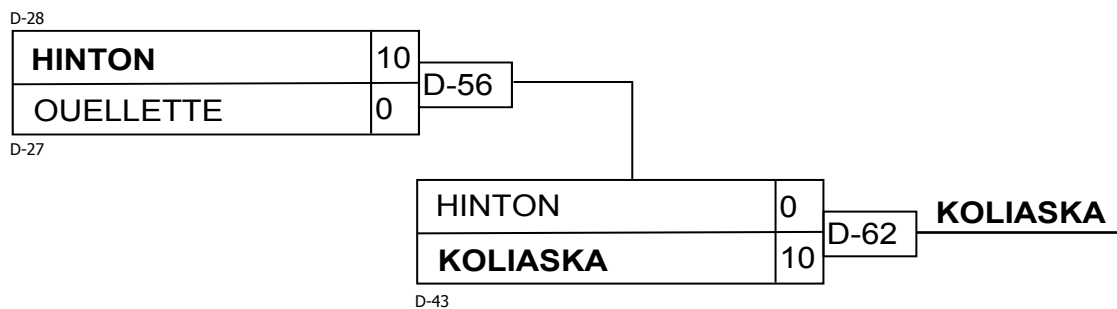
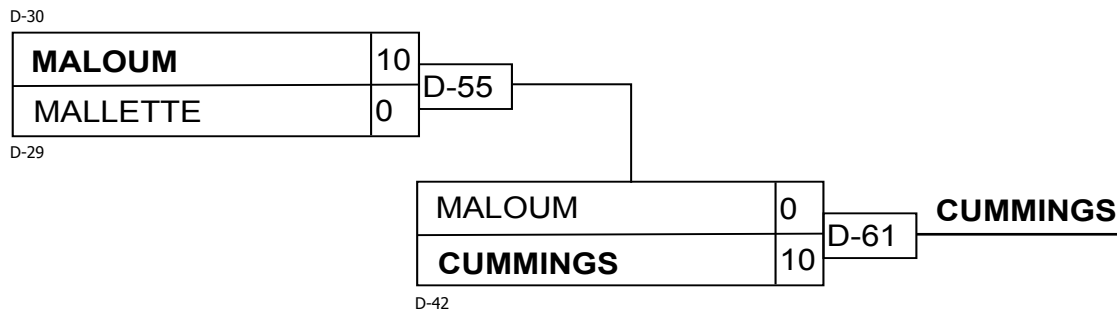

# U21F -57

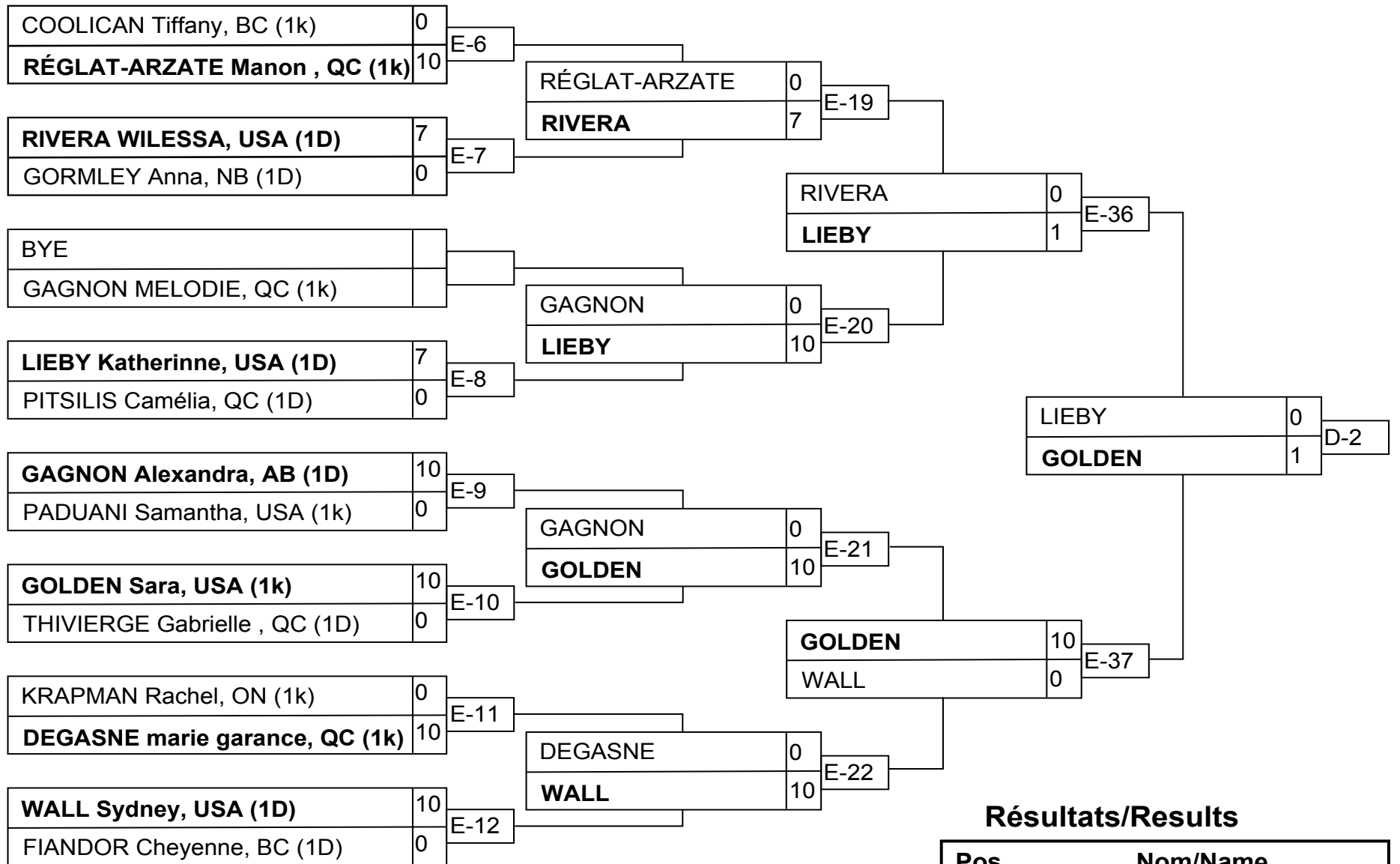

## Résultats/Results

Pos	Nom/Name
1	GOLDEN Sara, USA (1k)
2	LIEBY Katherinne, USA (1D)
3	PITSILIS Camélia, QC (1D)
3	THIVIERGE Gabrielle, QC (1D)

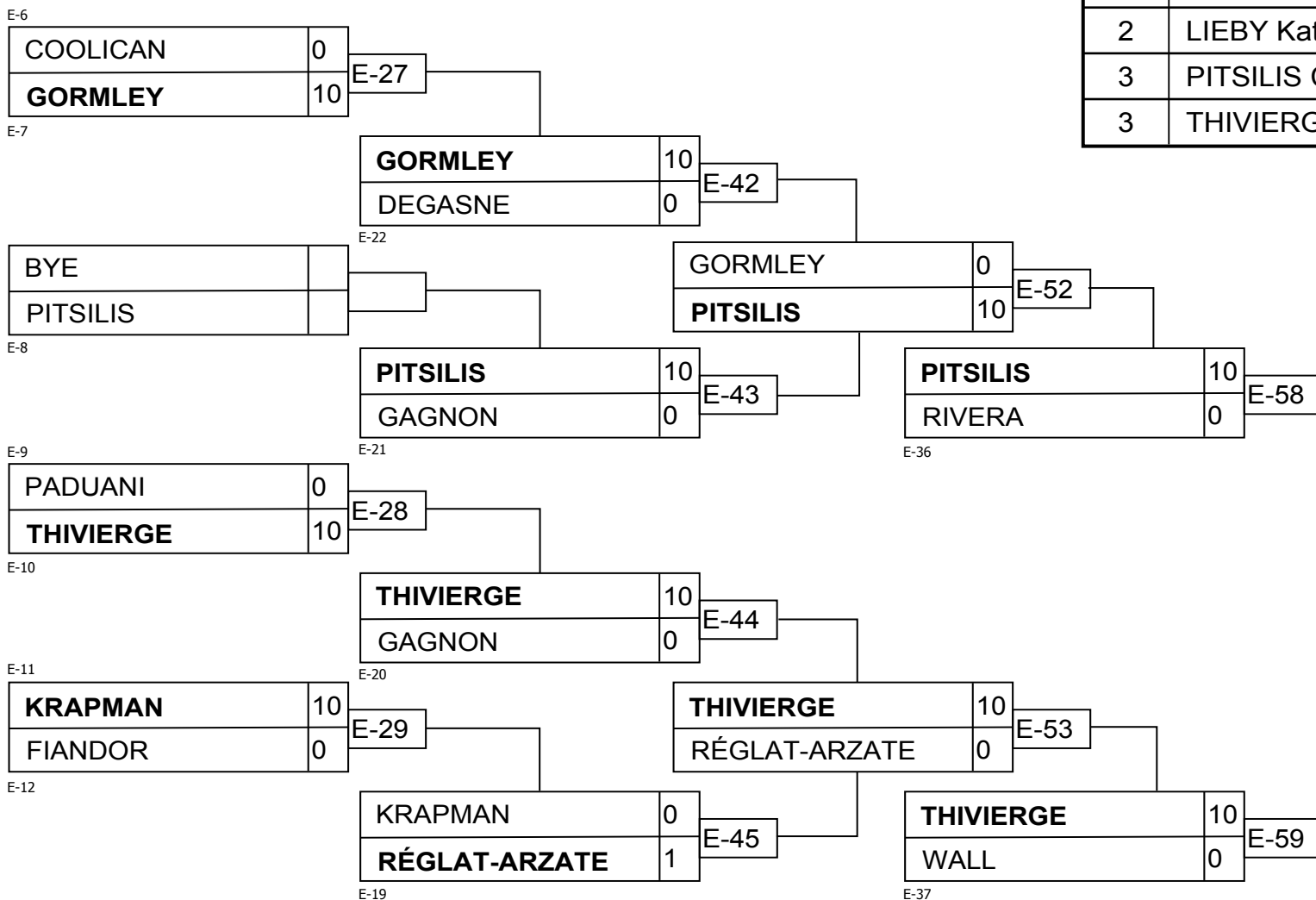

# U21F -63

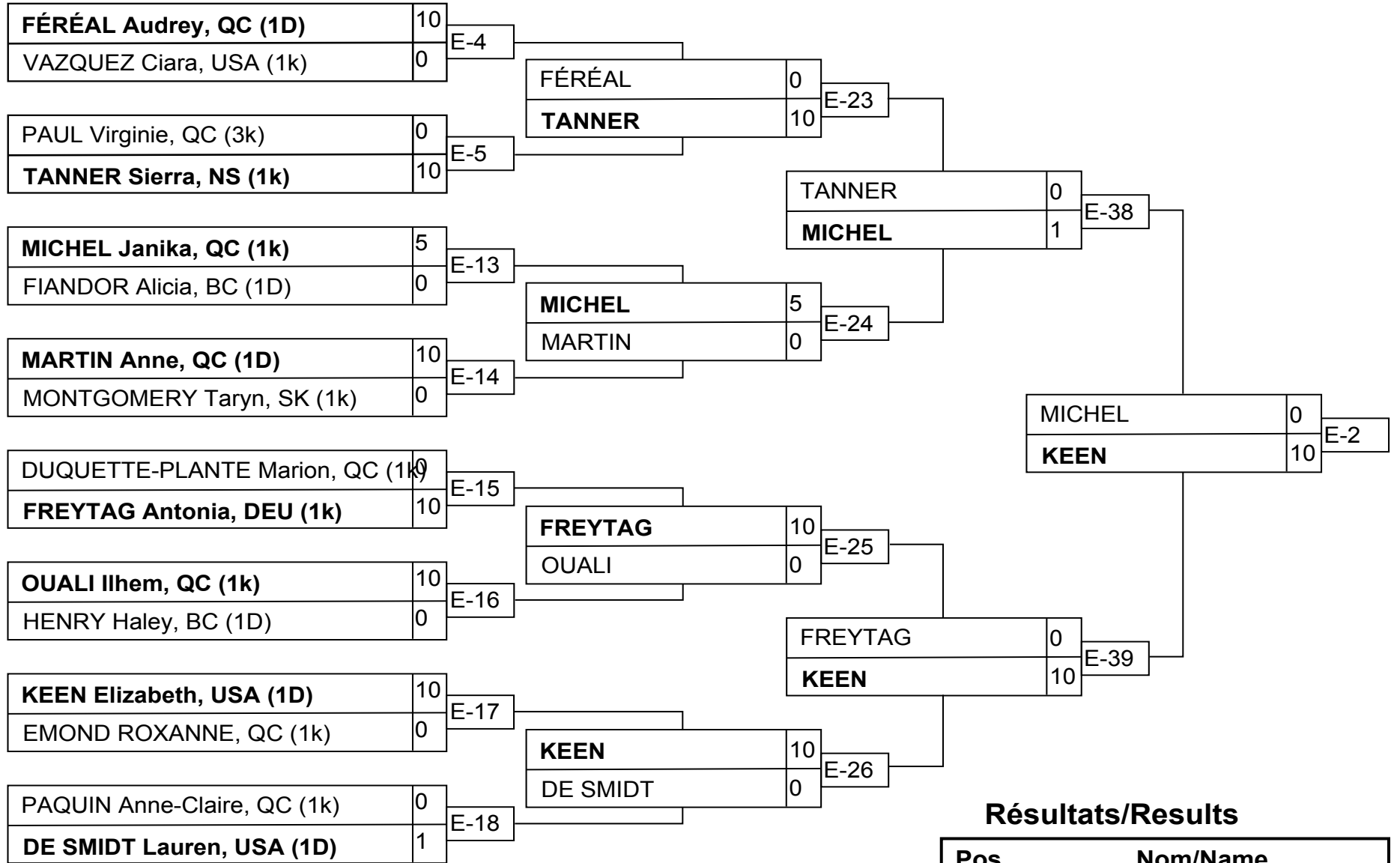

## Résultats/Results

Pos	Nom/Name
1	KEEN Elizabeth, USA (1D)
2	MICHEL Janika, QC (1k)
3	DE SMIDT Lauren, USA (1D)
3	FREYTAG Antonia, DEU (1k)

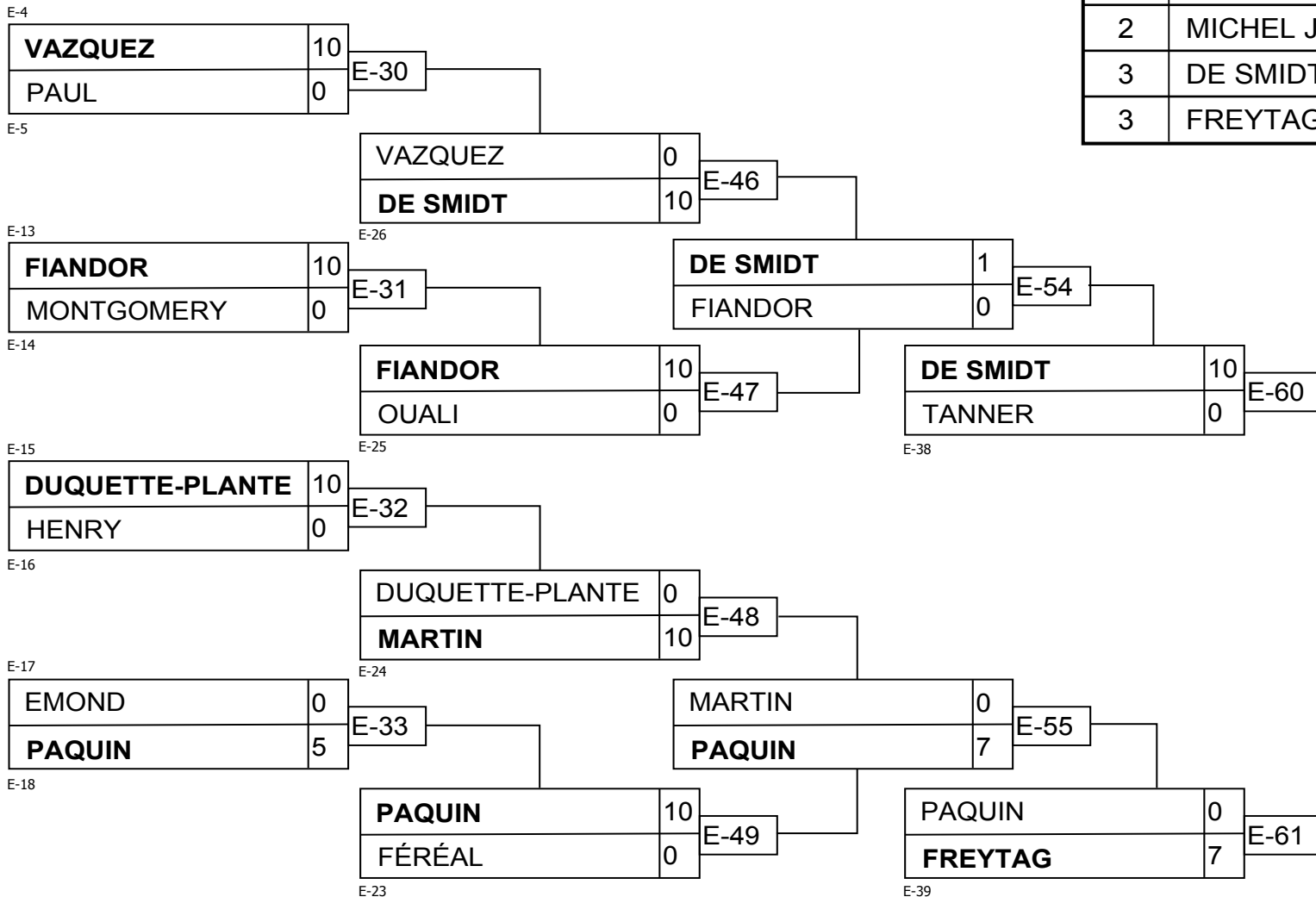

# U21F -70

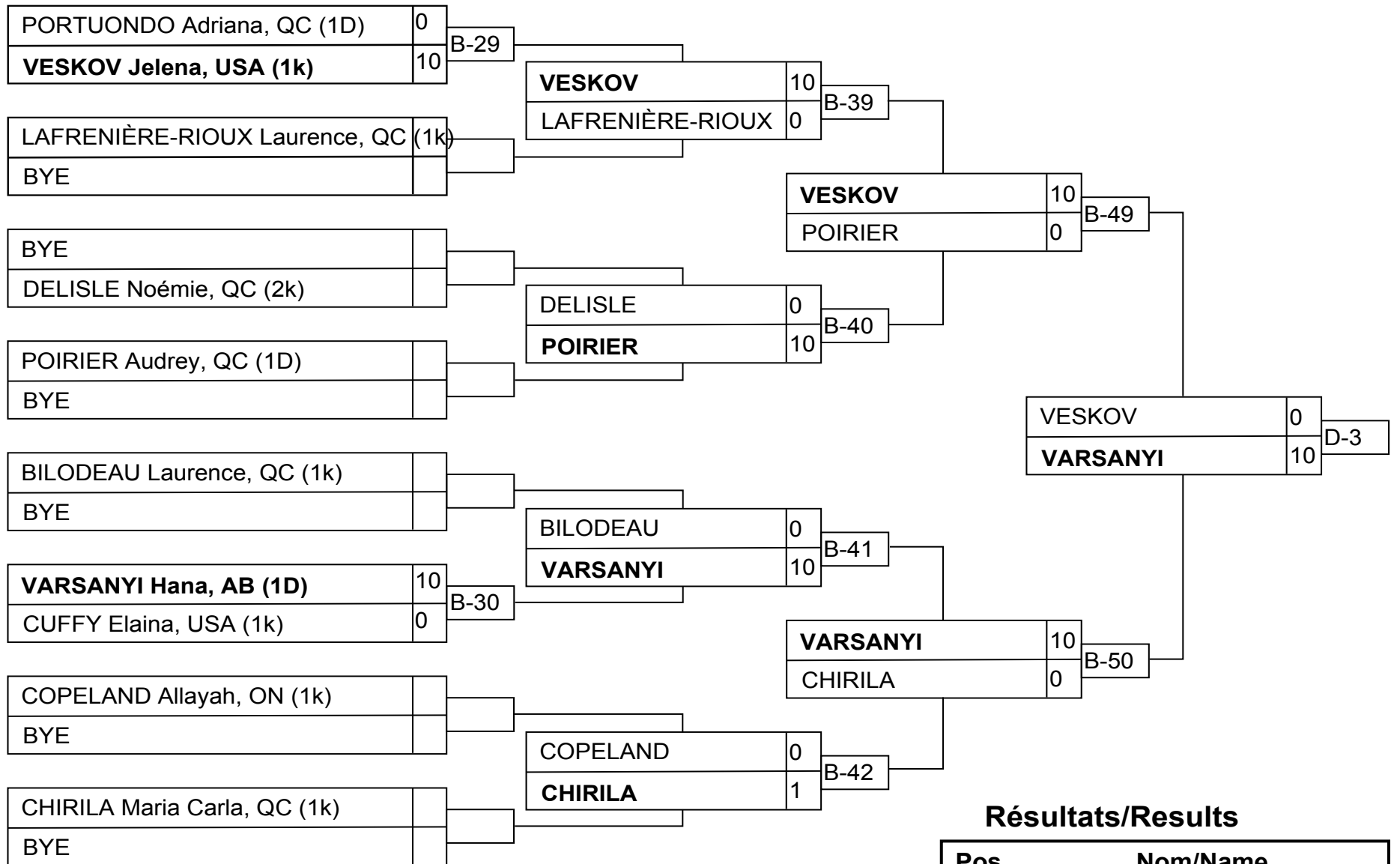

## Résultats/Results

Pos	Nom/Name
1	VARSAANYI Hana, AB (1D)
2	VESKOV Jelena, USA (1k)
3	COPELAND Allayah, ON (1k)
3	CHIRILA Maria Carla, QC (1k)

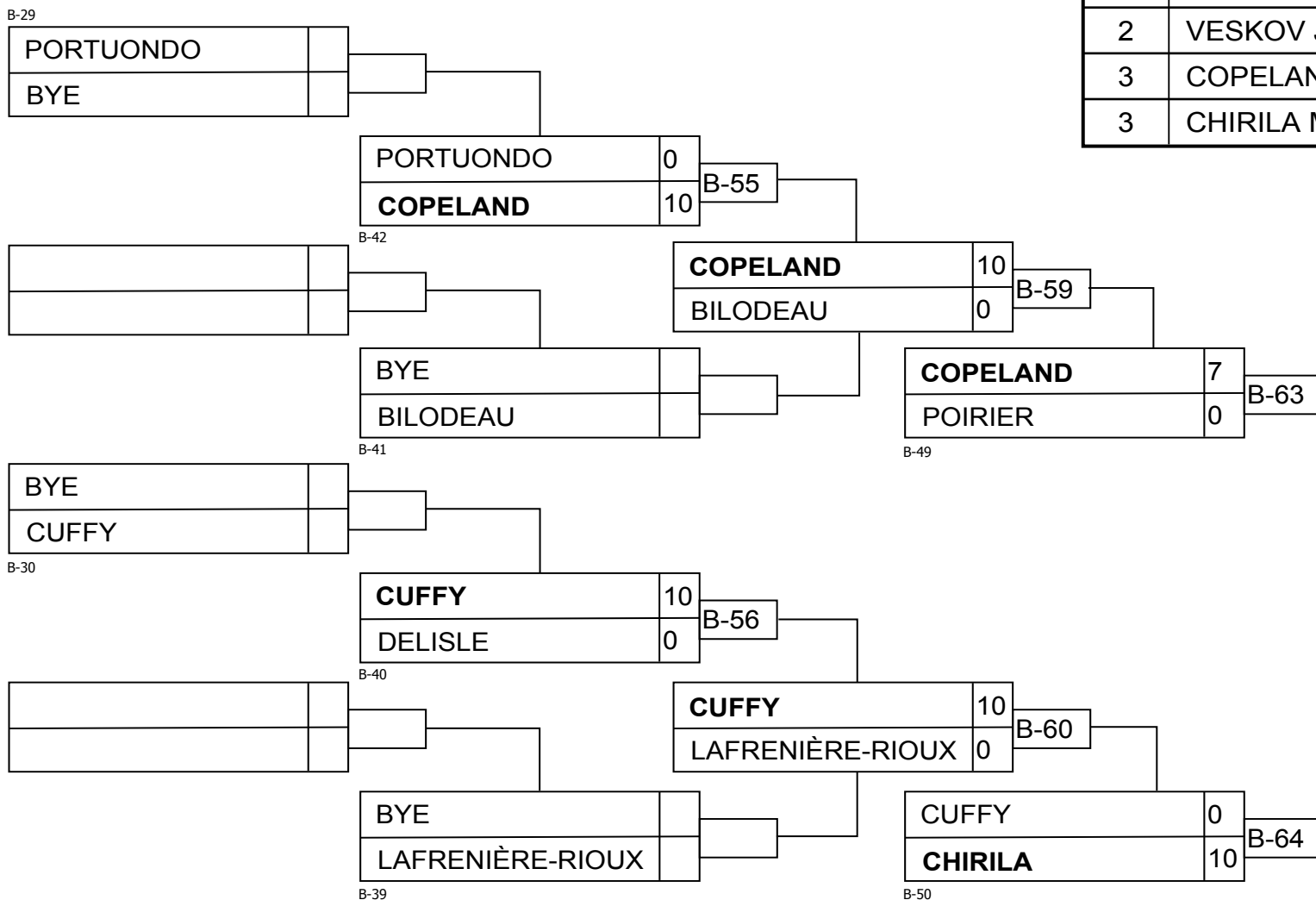



# U21F -78

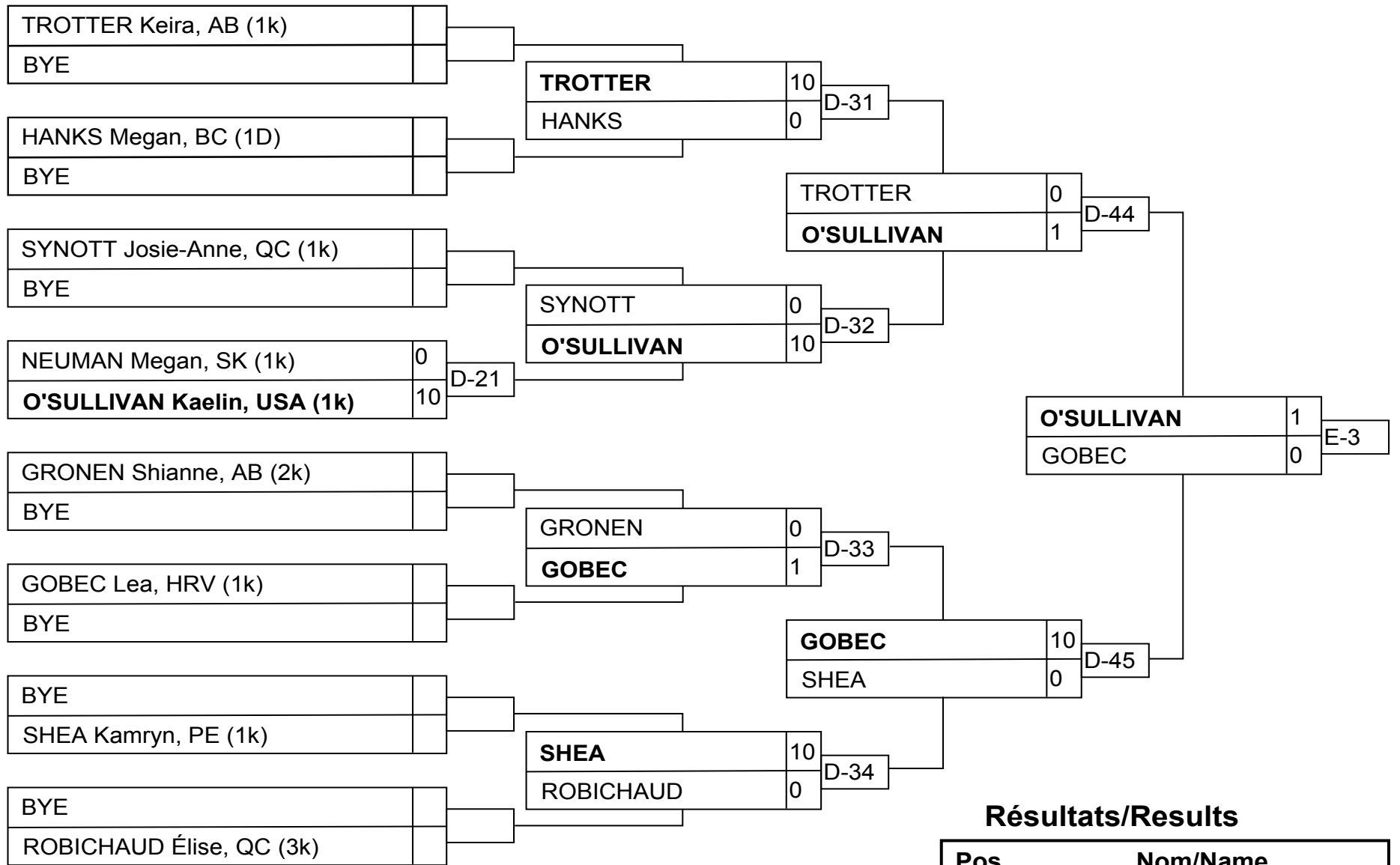

## Résultats/Results

Pos	Nom/Name
1	O'SULLIVAN Kaelin, USA (1k)
2	GOBEC Lea, HRV (1k)
3	TROTTER Keira, AB (1k)
3	HANKS Megan, BC (1D)

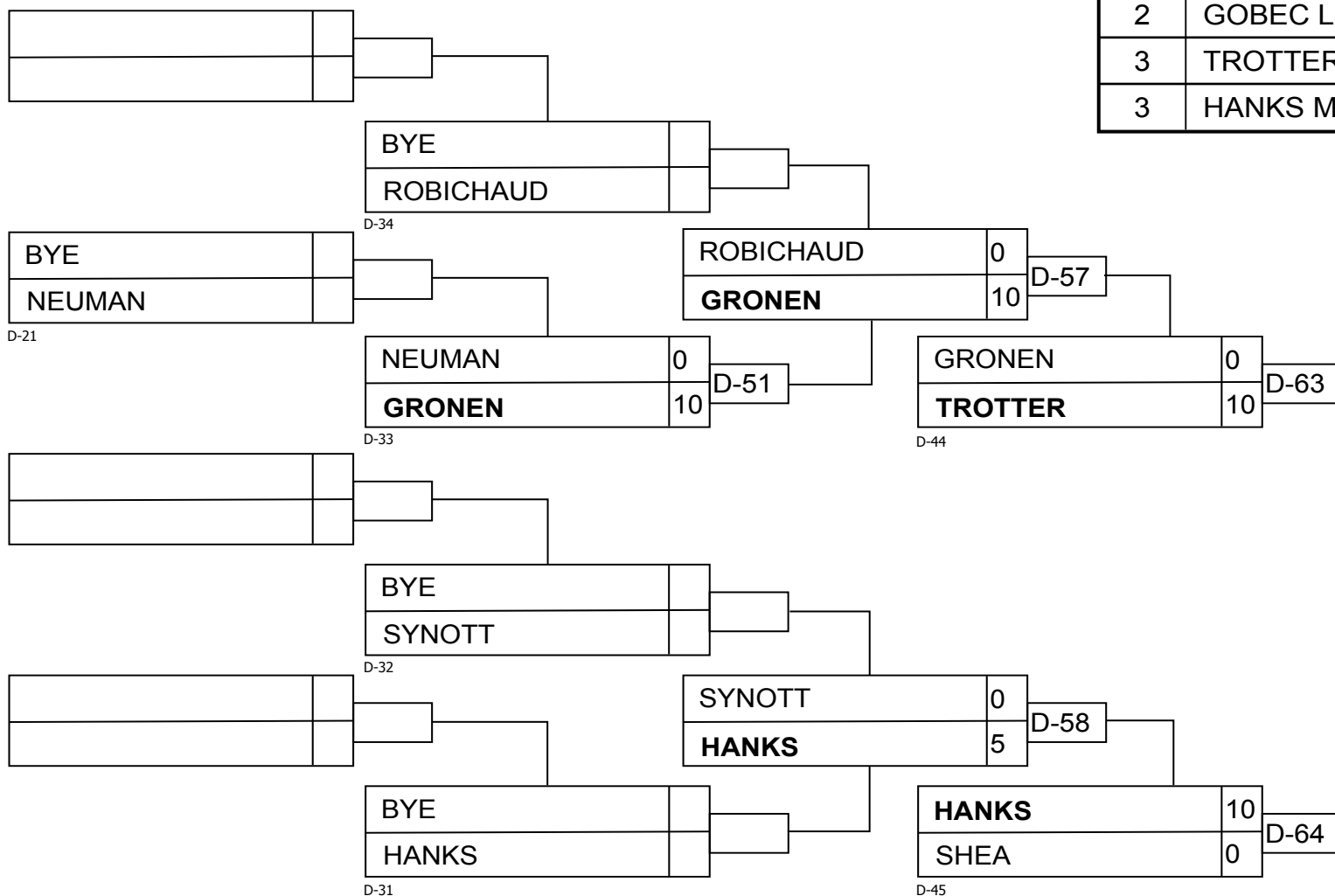

# Omnium 2016 4-5 novembre 2016 Montréal U21M +100

Compétiteurs/Competitors: 6

## Compétiteurs/Competitors A

#	Nom/Name	Grade	Club	1	2	3	G/W	Pts	Pos
1	VIENNEAU Andrew	1D	NB				0	0	3
2	PALTIELOV Joshua	?	USA	7			1	7	2
3	GAUTHIER Kevin	1D	QC	10	10		2	20	1

## Matches/Matches A

Match	Blanc/White			Bleu/Blue	Rés/Res	Tmp/Tim	Code
E-34	VIENNEAU Andrew	1	2	PALTIELOV Joshua	0 - 7	4:00	WAZ
E-40	VIENNEAU Andrew	1	3	GAUTHIER Kevin	0 - 10	1:08	IPO
E-50	PALTIELOV Joshua	2	3	GAUTHIER Kevin	0 - 10	2:04	WIP

## Compétiteurs/Competitors B

#	Nom/Name	Grade	Club	4	5	6	G/W	Pts	Pos
4	PAQUETTE Sébastien	2k	QC				0	0	3
5	BLANEY Andrew	1D	NB	10		7	2	17	1
6	DORÉ Nicholas	2k	ON	10			1	10	2

## Matches/Matches B

Match	Blanc/White			Bleu/Blue	Rés/Res	Tmp/Tim	Code
E-35	PAQUETTE Sébastien	4	5	BLANEY Andrew	0 - 10	0:20	IPO
E-41	PAQUETTE Sébastien	4	6	DORÉ Nicholas	0 - 10	2:23	IPO
E-51	BLANEY Andrew	5	6	DORÉ Nicholas	7 - 0	4:00	WAZ

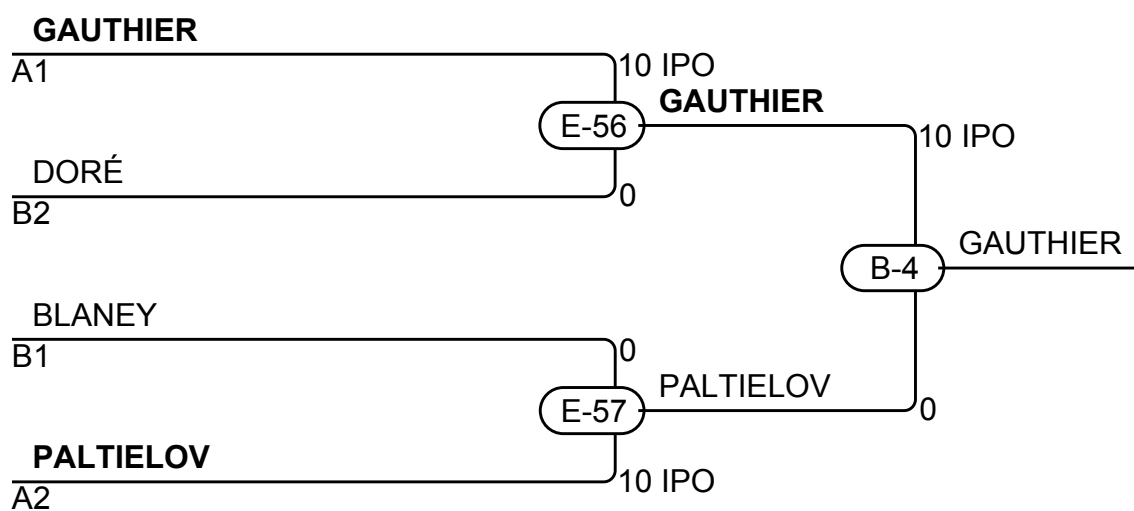

## Résultats/Results

Pos	Nom/Name
1	GAUTHIER Kevin, QC
2	PALTIELOV Joshua, USA
3	DORÉ Nicholas, ON
3	BLANEY Andrew, NB

# Omnium 2016 4-5 novembre 2016 Montréal U21M -100

Compétiteurs/Competitors: 3

## Compétiteurs/Competitors

#	Nom/Name	Grade	Club	1	2	3	G/W	Pts	Pos
1	AJRAM GABRIEL	2k	QC				0	0	3
2	EL NAHAS Shady	1k	ON	10		10	2	20	1
3	CHOUINARD Yohan	1k	QC	10			1	10	2

## Matches/Matches

Match	Blanc/White			Bleu/Blue	Rés/Res	Tmp/Tim	Code
D-39	AJRAM GABRIEL	1	2	EL NAHAS Shady	0 - 10	0:10	IPO
D-46	AJRAM GABRIEL	1	3	CHOUINARD Yohan	0 - 10	2:39	IPO
D-52	EL NAHAS Shady	2	3	CHOUINARD Yohan	10 - 0	0:06	IPO

## Résultats/Results

Pos	Nom/Name
1	EL NAHAS Shady, ON
2	CHOUINARD Yohan, QC
3	AJRAM GABRIEL, QC

# U21M -55

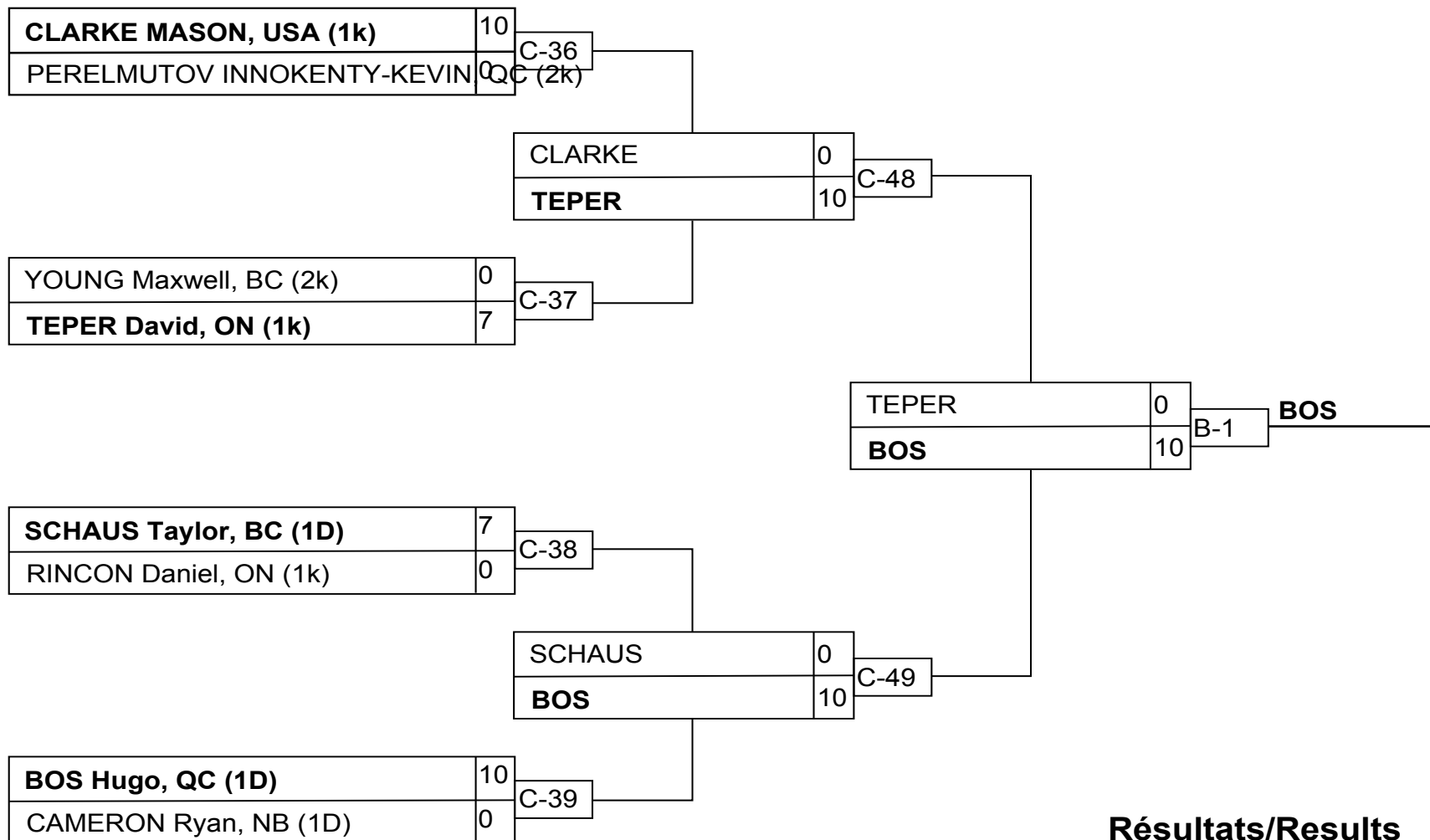

## Résultats/Results

Pos	Nom/Name
1	BOS Hugo, QC (1D)
2	TEPER David, ON (1k)
3	CLARKE MASON, USA (1k)
3	PERELMUTOV INNOKENTY-KEVIN

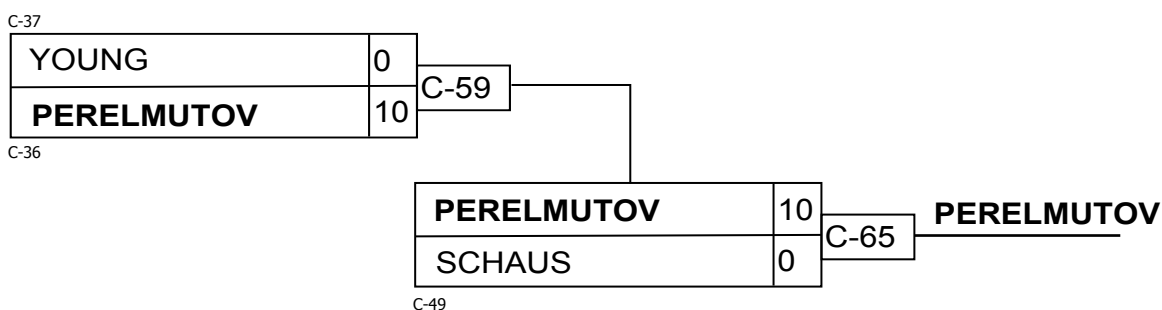
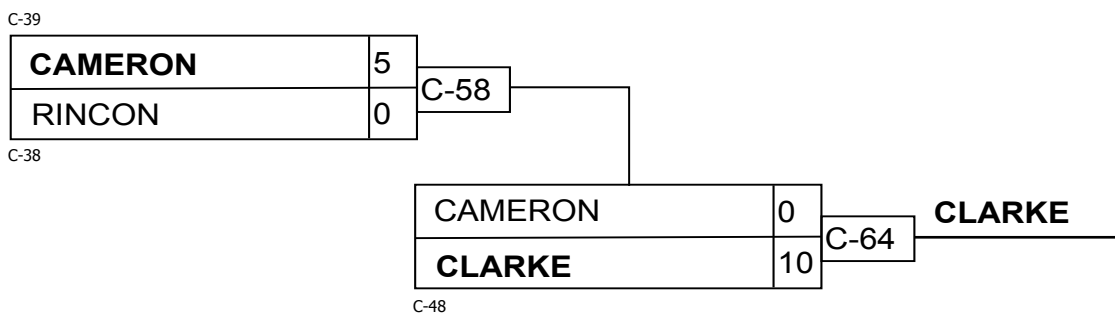

# U21M -60

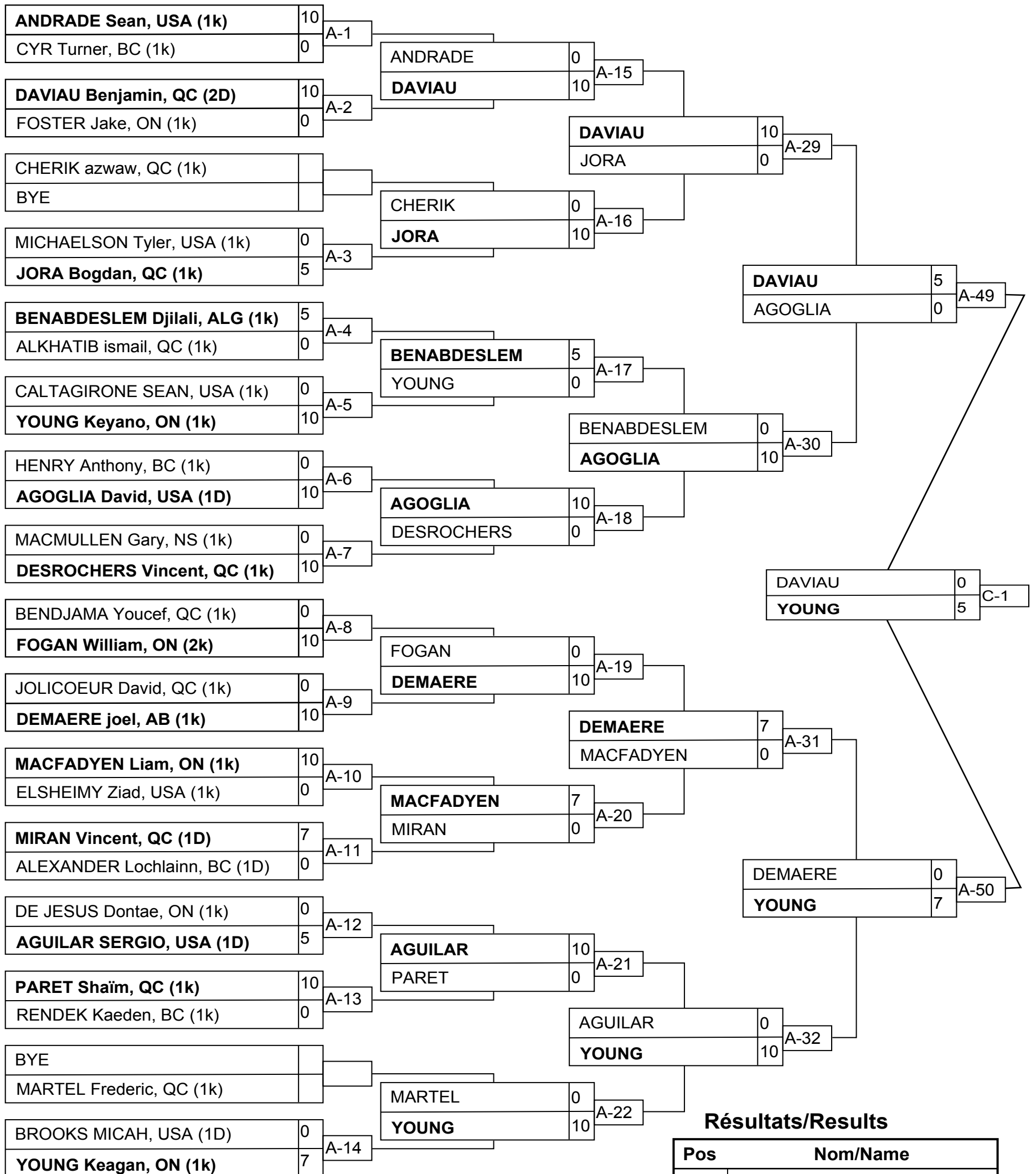

## Résultats/Results

Pos	Nom/Name
1	YOUNG Keagan, ON (1k)
2	DAVIAU Benjamin, QC (2D)
3	AGOGLIA David, USA (1D)
3	DEMAERE joel, AB (1k)

# U21M -60

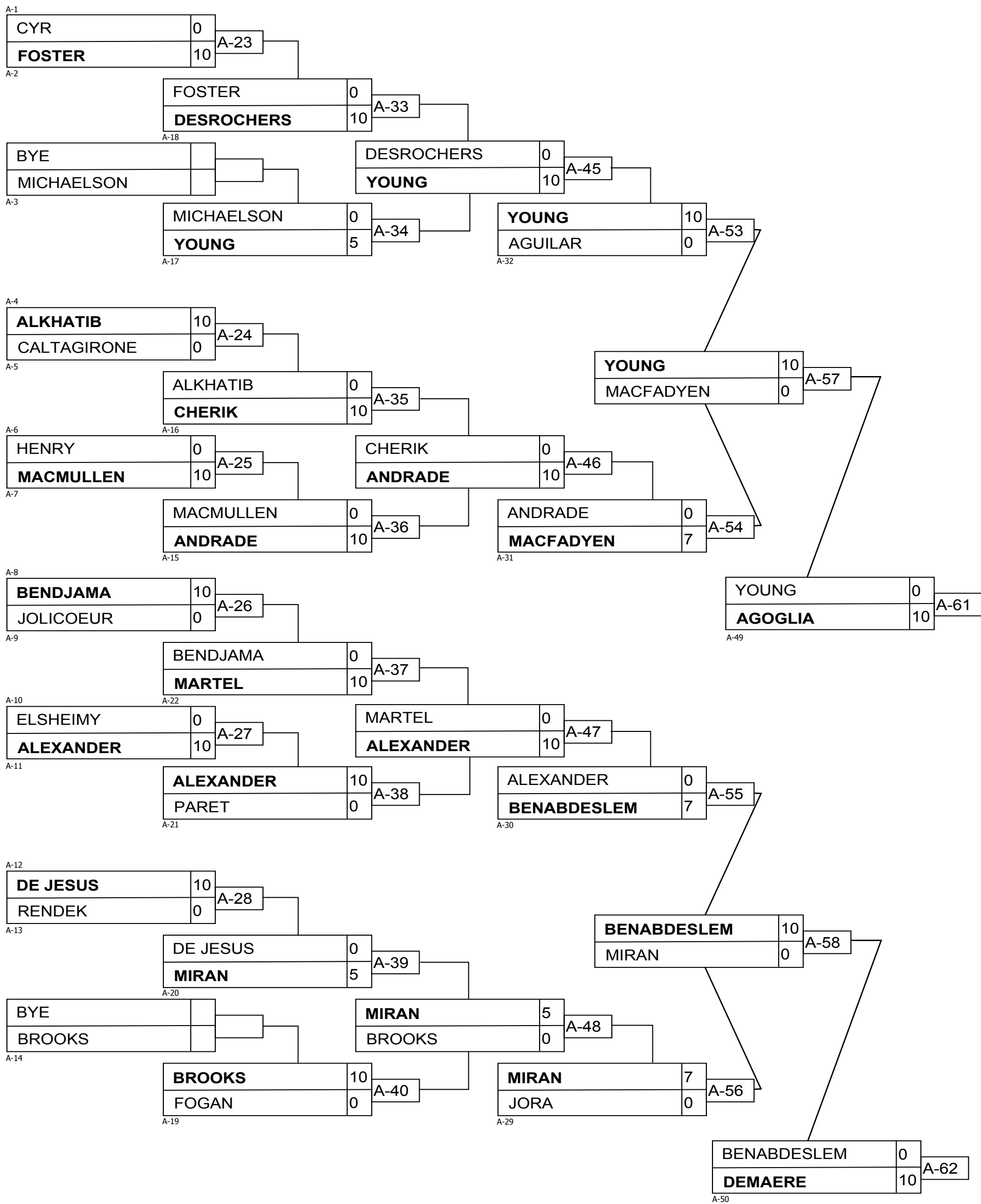

# U21M -66

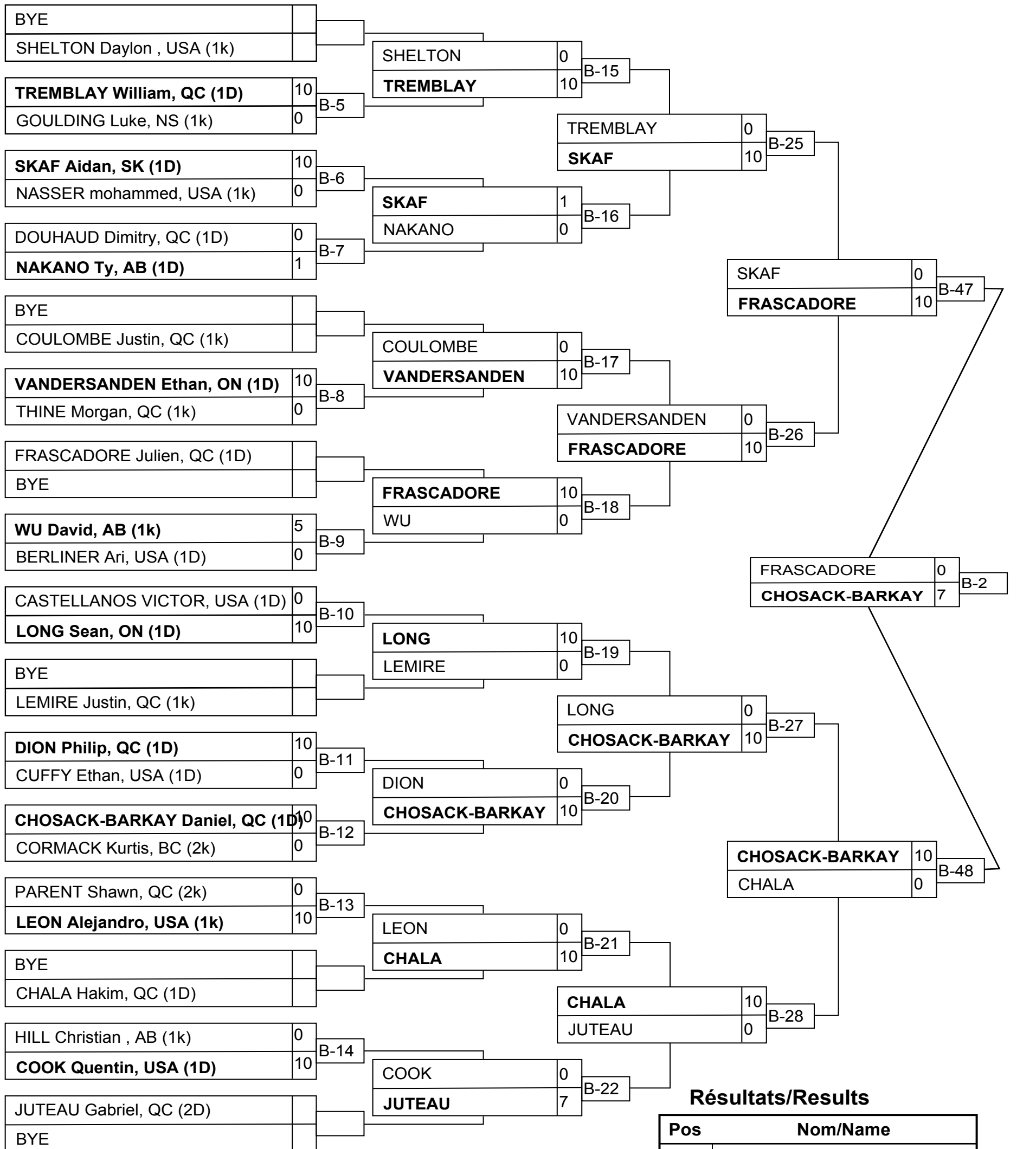

## Résultats/Results

Pos	Nom/Name
1	CHOSACK-BARKAY Daniel, QC (1D)
2	FRASCADORE Julien, QC (1D)
3	JUTEAU Gabriel, QC (2D)
3	COOK Quentin, USA (1D)

# U21M -66

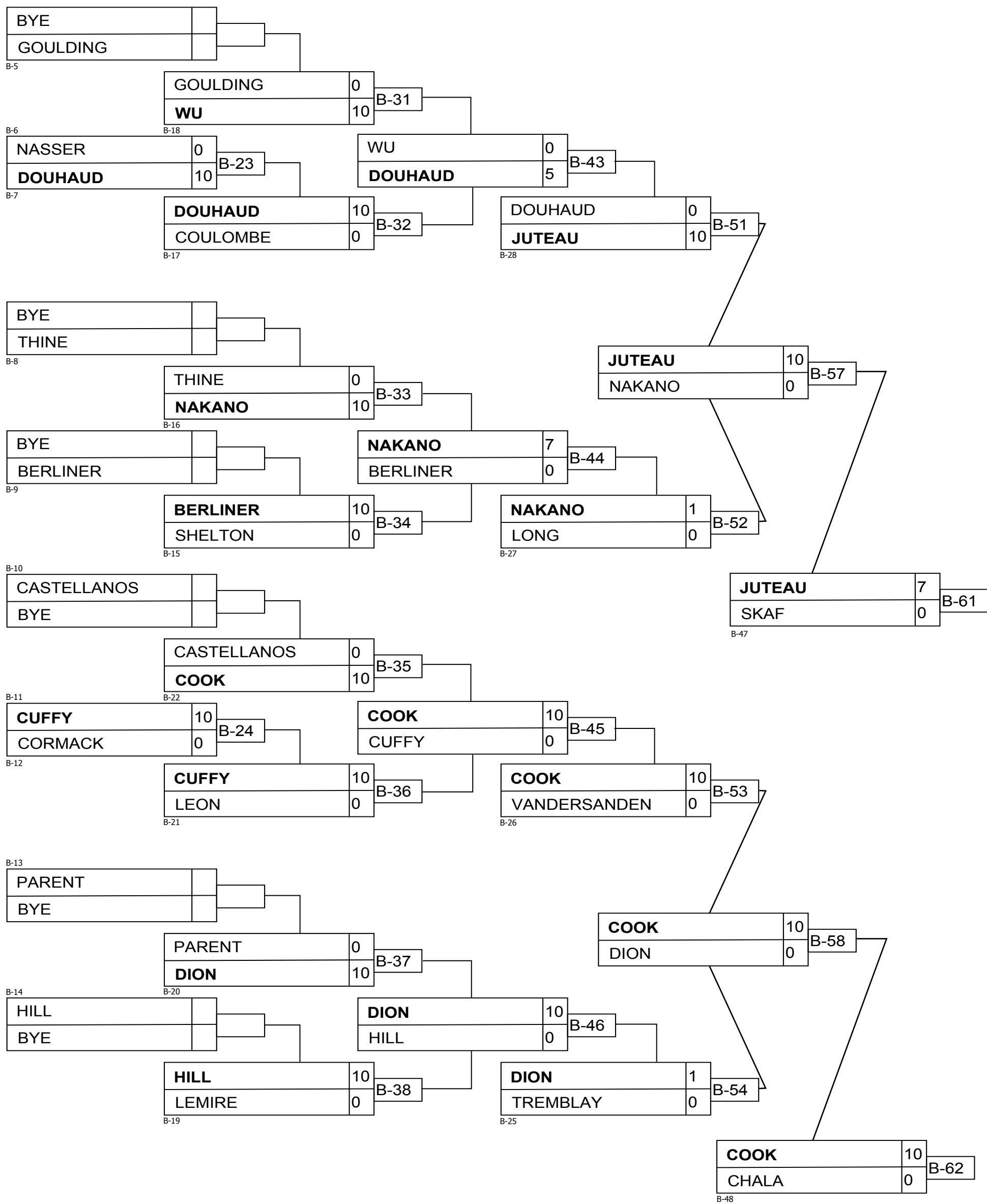



# U21M -73

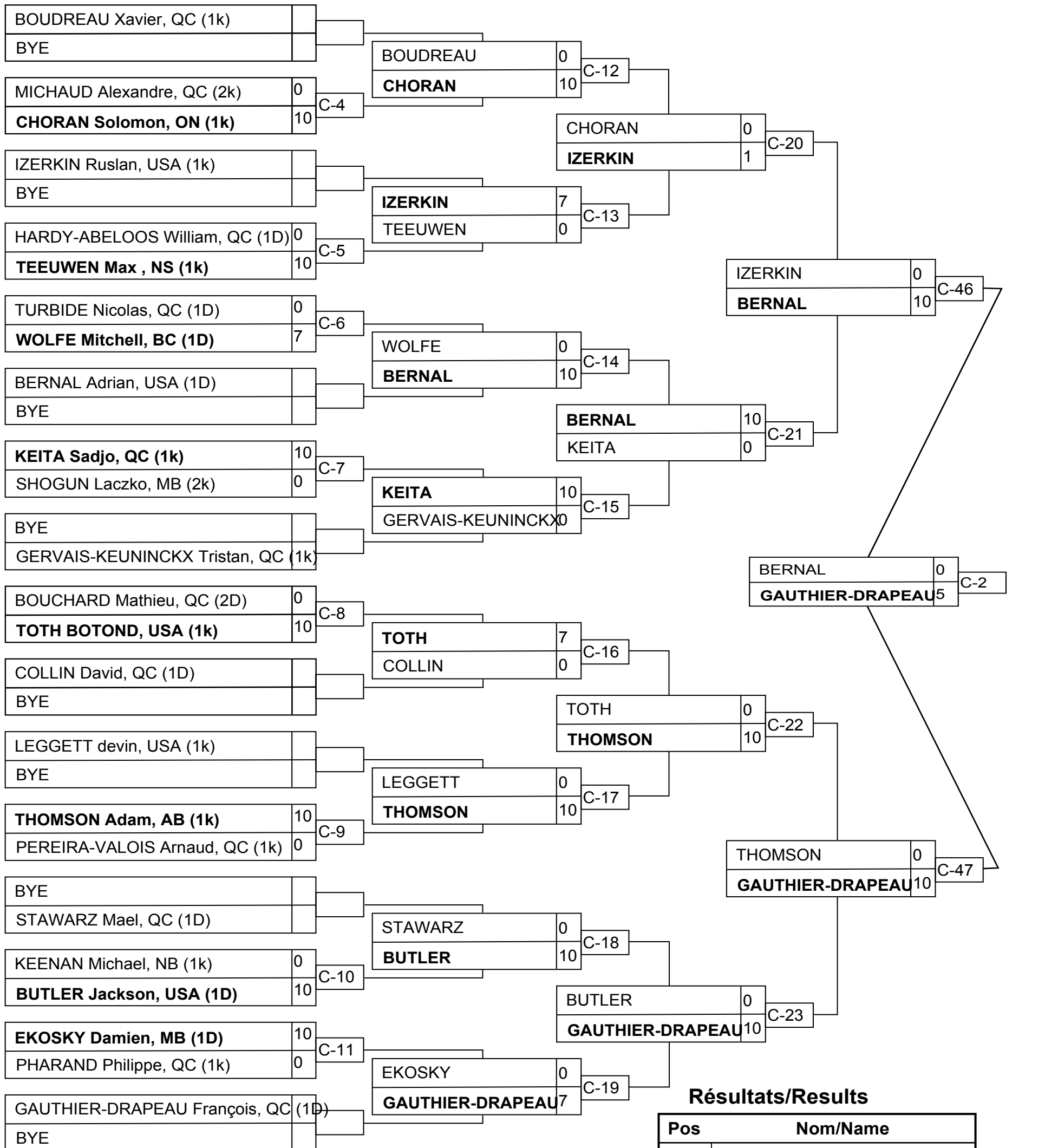

# U21M -73

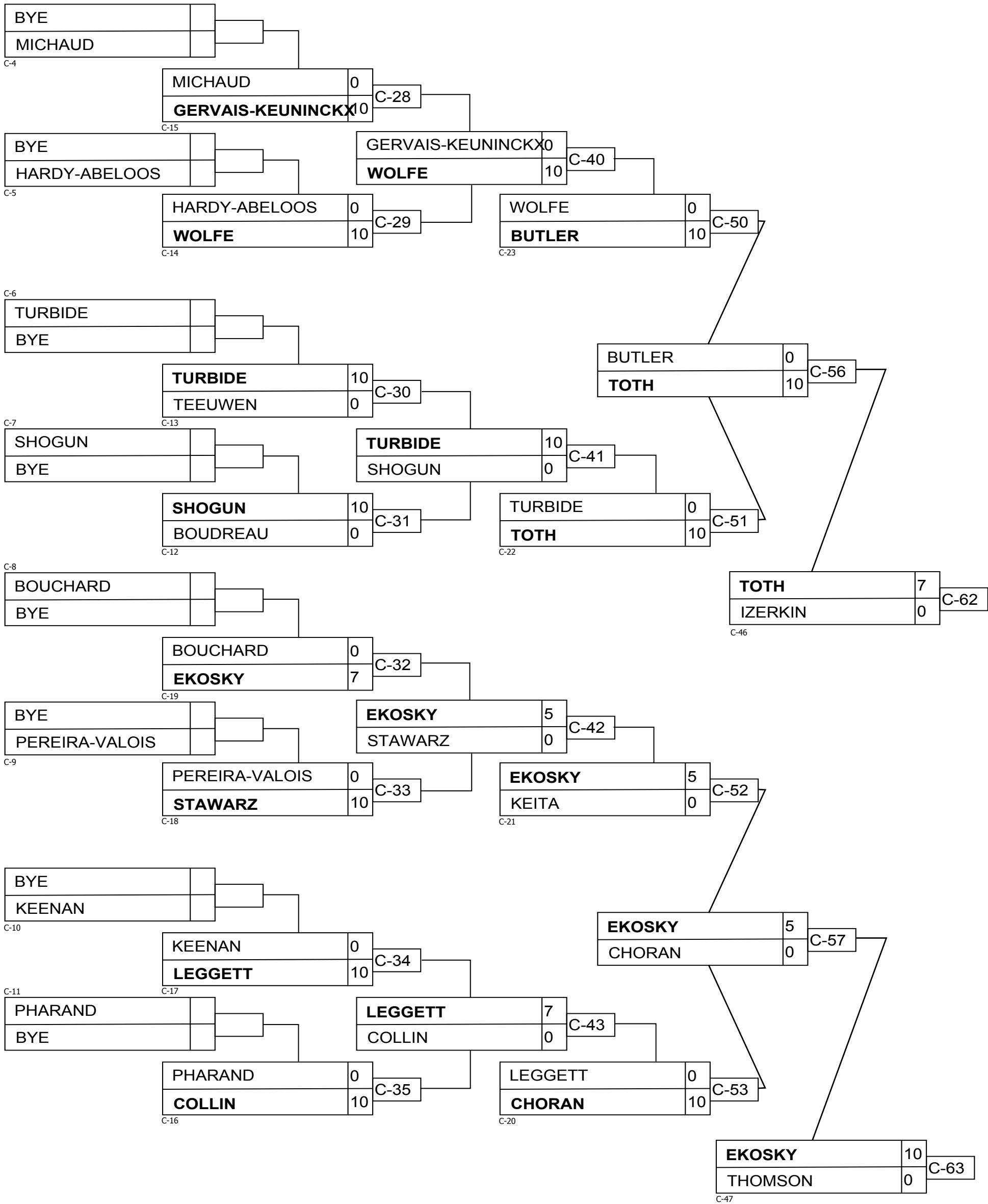

# U21M -81

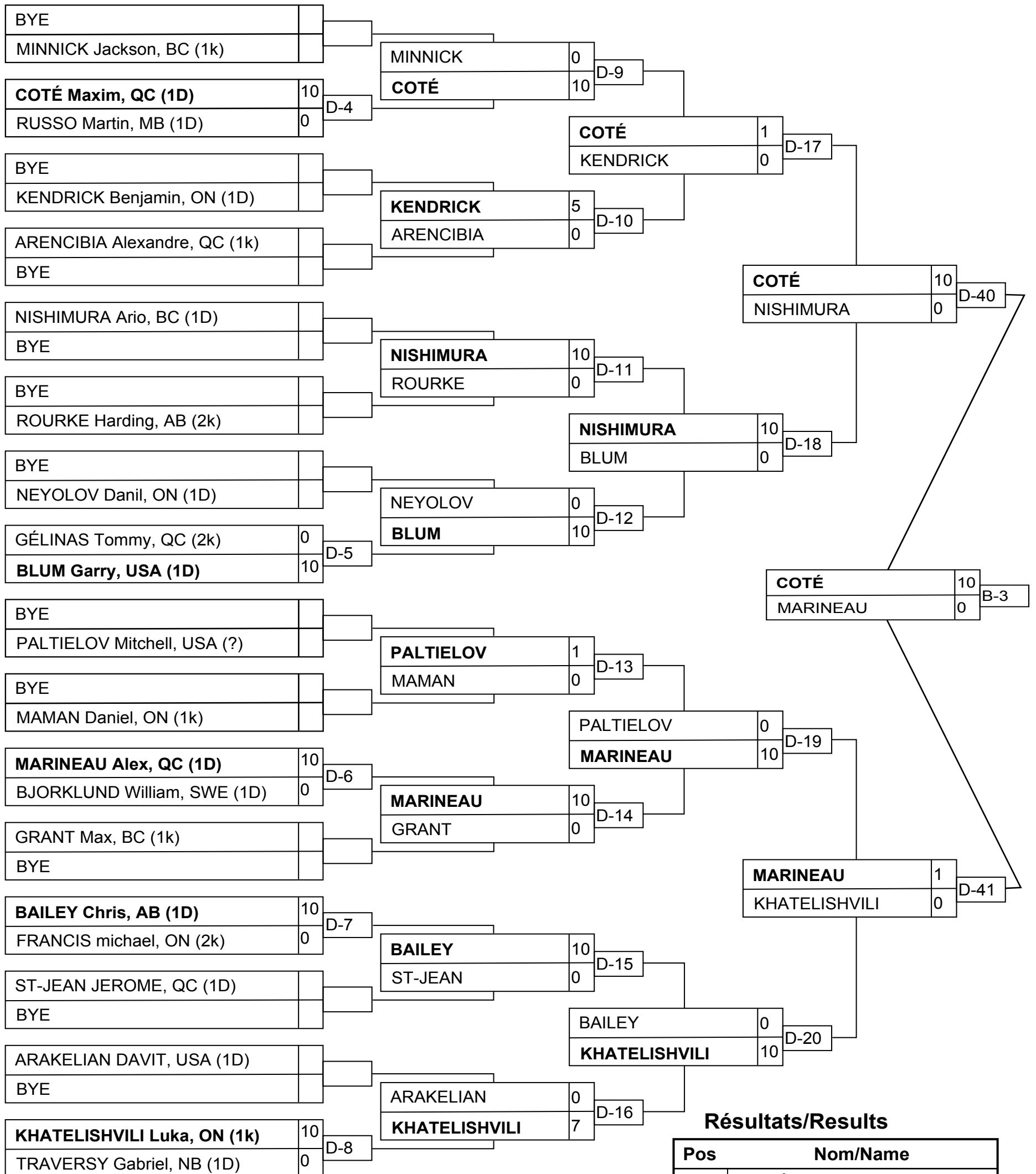

## Résultats/Results

Pos	Nom/Name
1	COTÉ Maxim, QC (1D)
2	MARINEAU Alex, QC (1D)
3	BAILEY Chris, AB (1D)
3	KENDRICK Benjamin, ON (1D)

# U21M -81

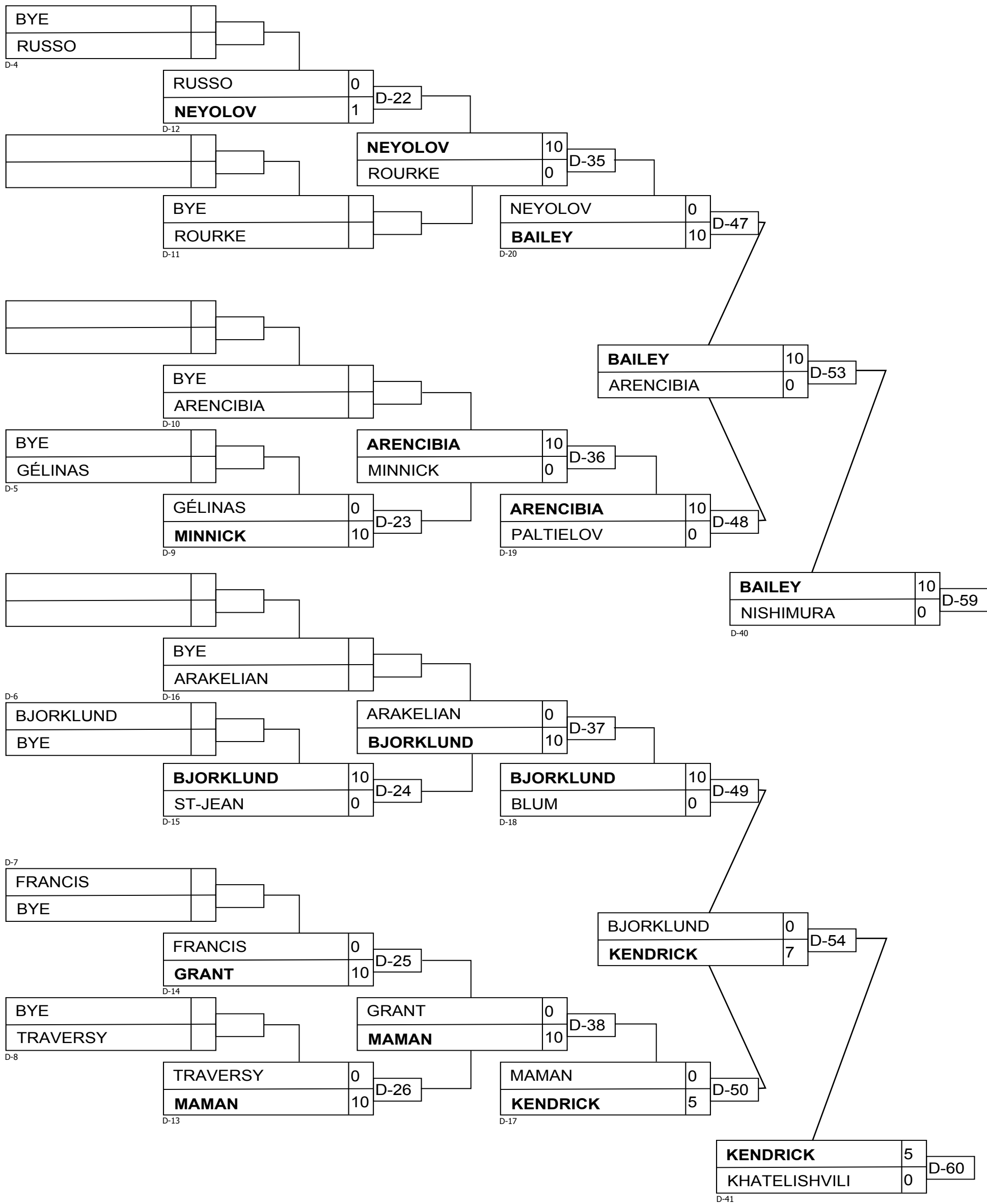

# U21M -90

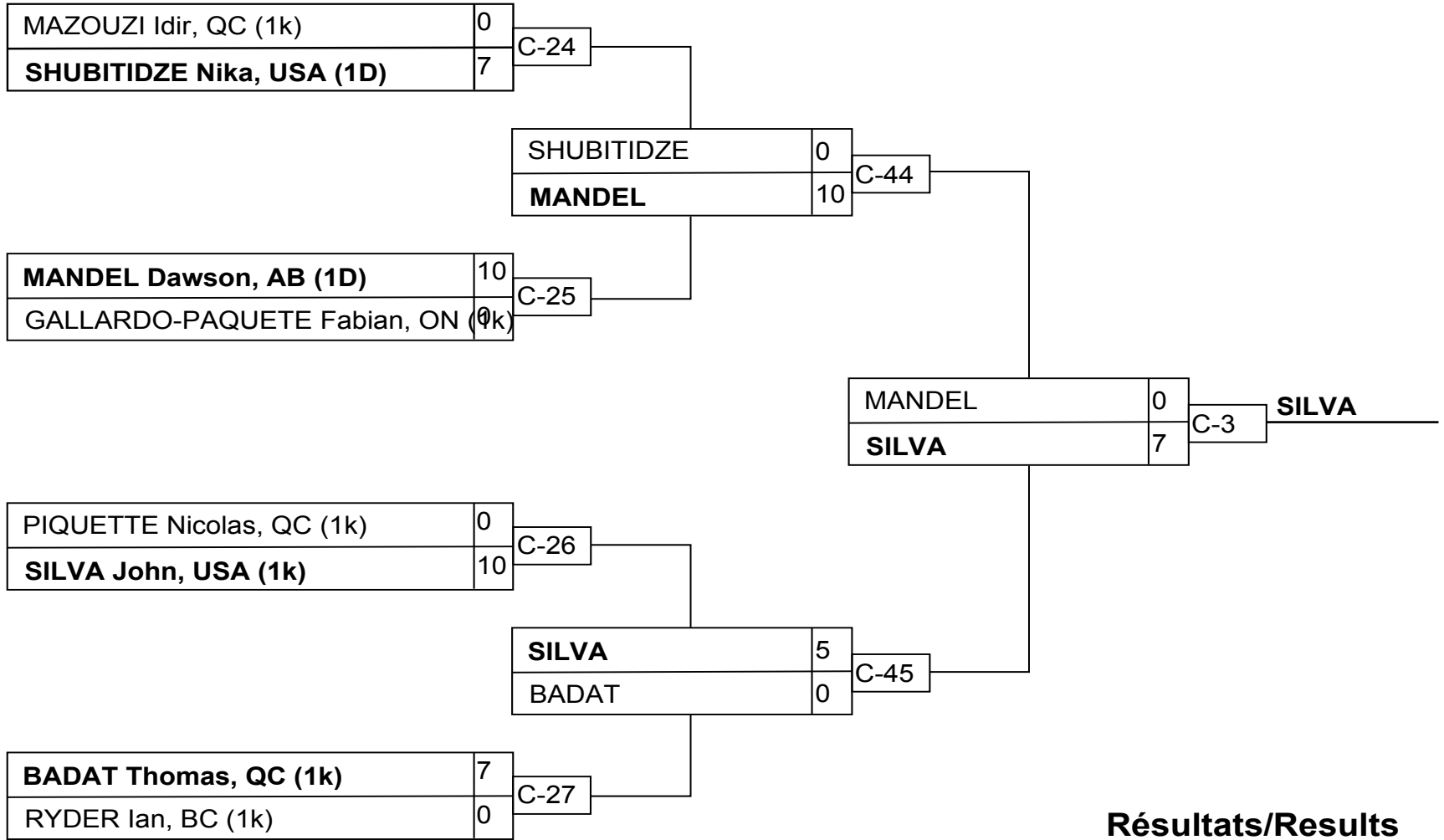

## Résultats/Results

Pos	Nom/Name
1	SILVA John, USA (1k)
2	MANDEL Dawson, AB (1D)
3	RYDER Ian, BC (1k)
3	MAZOUZI Idir, QC (1k)

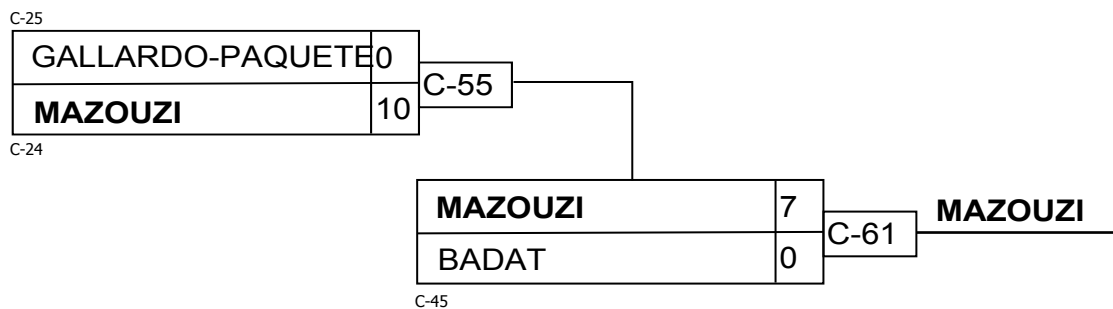
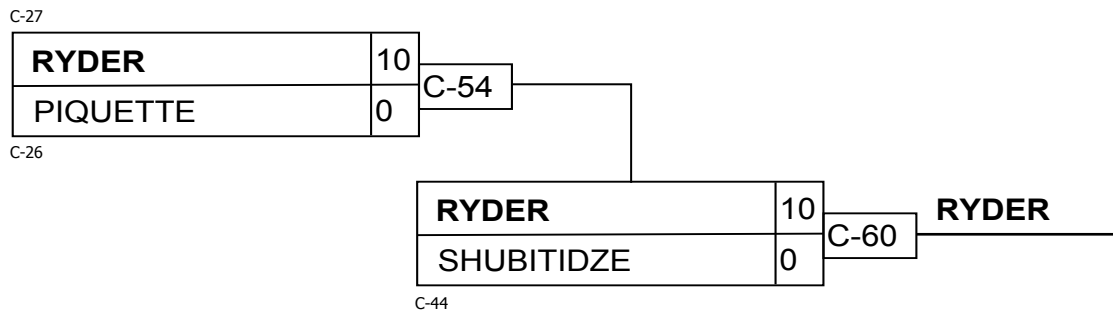

Compétiteurs/Competitors

#	Nom/Name	Grade	Club	1	2	3	4	5	G/W	Pts	Pos
1	BERTHIAUME Danny	1k	QC						0	0	5
2	FONTAINE-BÉGIN Julien	1D	QC	5		10			2	15	3
3	PELLERIN MARC-ANDRÉ	2k	QC	10					1	10	4
4	MILORD-NADON Arnaud	1D	QC	10	10	10			3	30	2
5	PLAMONDON Francois	1D	QC	10	10	10	7		4	37	1

Matches/Matches

Match	Blanc/White			Bleu/Blue	Rés/Res	Tmp/Tim	Code
F-5	MILORD-NADON Arnaud	4	5	PLAMONDON Francois	0 - 7	3:00	WAZ
F-6	BERTHIAUME Danny	1	2	FONTAINE-BÉGIN Julien	0 - 5	3:00	YUK
F-13	PELLERIN MARC-ANDRÉ	3	4	MILORD-NADON Arnaud	0 - 10	0:28	WIP
F-14	BERTHIAUME Danny	1	5	PLAMONDON Francois	0 - 10	0:50	IPO
F-22	FONTAINE-BÉGIN Julien	2	3	PELLERIN MARC-ANDRÉ	10 - 0	1:01	IPO
F-23	BERTHIAUME Danny	1	4	MILORD-NADON Arnaud	0 - 10	0:00	FUS
F-35	PELLERIN MARC-ANDRÉ	3	5	PLAMONDON Francois	0 - 10	0:46	IPO
F-36	FONTAINE-BÉGIN Julien	2	4	MILORD-NADON Arnaud	0 - 10	1:47	WIP
F-48	BERTHIAUME Danny	1	3	PELLERIN MARC-ANDRÉ	0 - 10	0:00	KIK
F-49	FONTAINE-BÉGIN Julien	2	5	PLAMONDON Francois	0 - 10	0:52	WIP

Résultats/Results

Pos	Nom/Name
1	PLAMONDON Francois , QC
2	MILORD-NADON Arnaud, QC
3	FONTAINE-BÉGIN Julien, QC
4	PELLERIN MARC-ANDRÉ, QC
5	BERTHIAUME Danny, QC

# Omnium 2016 4-5 novembre 2016 Montréal Vet M1M3 +100

Compétiteurs/Competitors: 5

## Compétiteurs/Competitors

#	Nom/Name	Grade	Club	1	2	3	4	5	G/W	Pts	Pos
1	MCMANUS James	2D	NB		10	10	10	10	4	40	1
2	ALLEN Jeff	1k	ON			10	10	10	3	30	2
3	KANE Amath	1D	QC					10	1	10	4
4	STANLEY Peter	1D	USA			10		10	2	20	3
5	CHEVREFILS Chad	1k	ON						0	0	5

## Matches/Matches

Match	Blanc/White			Bleu/Blue	Rés/Res	Tmp/Tim	Code
F-9	STANLEY Peter	4	5	CHEVREFILS Chad	10 - 0	0:30	WIP
F-10	MCMANUS James	1	2	ALLEN Jeff	10 - 0	1:44	WIP
F-17	KANE Amath	3	4	STANLEY Peter	0 - 10	0:00	WIP
F-18	MCMANUS James	1	5	CHEVREFILS Chad	10 - 0	0:20	IPO
F-26	ALLEN Jeff	2	3	KANE Amath	10 - 0	1:47	HAN
F-27	MCMANUS James	1	4	STANLEY Peter	10 - 0	0:25	IPO
F-39	KANE Amath	3	5	CHEVREFILS Chad	10 - 0	1:01	IPO
F-40	ALLEN Jeff	2	4	STANLEY Peter	10 - 0	1:44	IPO
F-52	MCMANUS James	1	3	KANE Amath	10 - 0	1:21	WIP
F-53	ALLEN Jeff	2	5	CHEVREFILS Chad	10 - 0	0:28	WIP

## Résultats/Results

Pos	Nom/Name
1	MCMANUS James, NB
2	ALLEN Jeff, ON
3	STANLEY Peter, USA
4	KANE Amath, QC
5	CHEVREFILS Chad, ON

## Compétiteurs/Competitors A

#	Nom/Name	Grade	Club	1	2	3	4	G/W	Pts	Pos
1	KINGSTON Robert	1D	AB				10	1	10	3
2	GRENIER PATRICK	1D	QC	10			10	2	20	2
3	MAROC Gregory	1D	FRA	10	10		10	3	30	1
4	CYR Christian	1D	QC					0	0	4

## Matches/Matches A

Match	Blanc/White	Bleu/Blue	Rés/Res	Tmp/Tim	Code
F-1	KINGSTON Robert 1 2	GRENIER PATRICK	0 - 10	2:52	IPO
F-2	MAROC Gregory 3 4	CYR Christian	10 - 0	0:51	IPO
F-30	KINGSTON Robert 1 3	MAROC Gregory	0 - 10	0:38	WIP
F-31	GRENIER PATRICK 2 4	CYR Christian	10 - 0	0:42	WIP
F-43	KINGSTON Robert 1 4	CYR Christian	10 - 0	0:21	IPO
F-44	GRENIER PATRICK 2 3	MAROC Gregory	0 - 10	0:20	IPO

## Compétiteurs/Competitors B

#	Nom/Name	Grade	Club	5	6	7	G/W	Pts	Pos
5	LYCKE Ambroise	1D	QC		10	10	2	20	1
6	CALZADA ASTENGO Hayro	1k	QC				0	0	3
7	GORMAN Alex	1k	USA		10		1	10	2

## Matches/Matches B

Match	Blanc/White	Bleu/Blue	Rés/Res	Tmp/Tim	Code
F-19	LYCKE Ambroise 5 6	CALZADA ASTENGO Hayro	10 - 0	0:45	IPO
F-32	LYCKE Ambroise 5 7	GORMAN Alex	10 - 0	0:00	IPO
F-45	CALZADA ASTENGO Hayro 6 7	GORMAN Alex	0 - 10	0:27	IPO

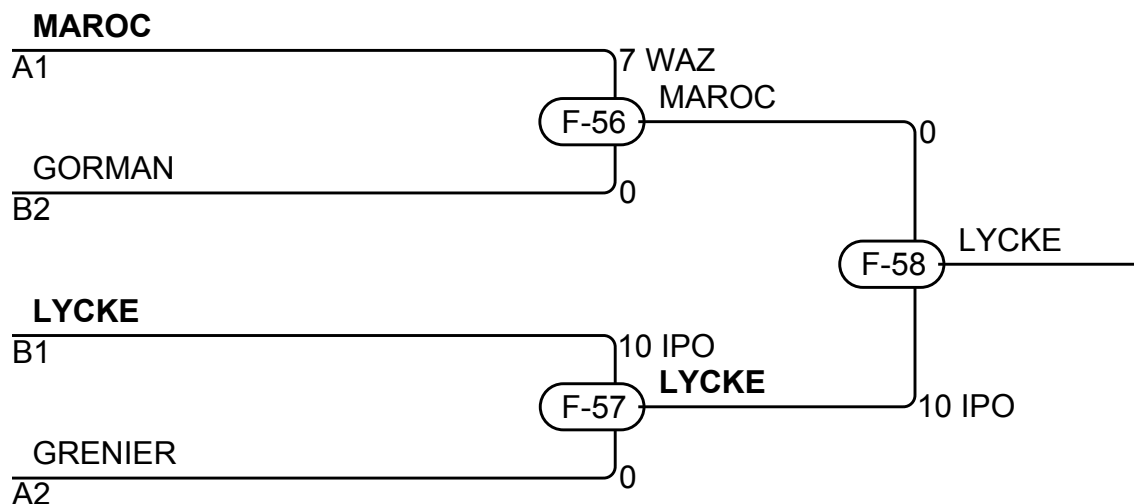

## Résultats/Results

Pos	Nom/Name
1	LYCKE Ambroise, QC
2	MAROC Gregory, FRA
3	GORMAN Alex, USA
3	GRENIER PATRICK, QC



# Omnium 2016 4-5 novembre 2016 Montréal Vet M1M4 léger/light

Compétiteurs/Competitors: 4

## Compétiteurs/Competitors

#	Nom/Name	Grade	Club	1	2	3	4	G/W	Pts	Pos
1	KRATKY Lloyd	1D	AB		10	10	10	3	30	1
2	TAKAHASHI Tim	2D	AB					0	0	4
3	KARN Justin	2D	QC		10		10	2	20	2
4	MALLETTE Benoît	2k	QC		10			1	10	3

## Matches/Matches

Match	Blanc/White			Bleu/Blue	Rés/Res	Tmp/Tim	Code
F-28	<b>KRATKY Lloyd</b>	1	2	TAKAHASHI Tim	10 - 0	3:00	WIP
F-29	<b>KARN Justin</b>	3	4	MALLETTE Benoît	10 - 0	2:46	IPO
F-41	<b>KRATKY Lloyd</b>	1	3	KARN Justin	10 - 0	0:00	IPO
F-42	TAKAHASHI Tim	2	4	<b>MALLETTE Benoît</b>	0 - 10	0:44	IPO
F-54	<b>KRATKY Lloyd</b>	1	4	MALLETTE Benoît	10 - 0	1:14	IPO
F-55	TAKAHASHI Tim	2	3	<b>KARN Justin</b>	0 - 10	0:57	IPO

## Résultats/Results

Pos	Nom/Name
1	KRATKY Lloyd, AB
2	KARN Justin, QC
3	MALLETTE Benoît, QC
4	TAKAHASHI Tim, AB

Compétiteurs/Competitors

#	Nom/Name	Grade	Club	1	2	3	4	5	G/W	Pts	Pos
1	GILBERT DANIEL	1k	QC					10	1	10	
2	KOSTROVETS VLADIMIR	2D	QC	10		10			2	20	
3	VENUGOPAL Rajeev	1D	ON	10				10	2	20	
4	RODRIGUES JUNIOR Lucio Flavio	1D	QC	10	10	10		10	4	40	
5	BERTRAND Jean-Francois	2D	QC								

Matches/Matches

Match	Blanc/White			Bleu/Blue	Rés/Res	Tmp/Tim	Code
F-7	<b>RODRIGUES JUNIOR Lucio Flavio</b>	4	5	BERTRAND Jean-Francois	10 - 0	0:00	WIP
F-8	GILBERT DANIEL	1	2	<b>KOSTROVETS VLADIMIR</b>	0 - 10	0:00	IPO
F-15	VENUGOPAL Rajeev	3	4	<b>RODRIGUES JUNIOR Lucio Flavio</b>	0 - 10	2:12	WIP
F-16	<b>GILBERT DANIEL</b>	1	5	BERTRAND Jean-Francois	10 - 0	0:00	FUS
F-24	<b>KOSTROVETS VLADIMIR</b>	2	3	VENUGOPAL Rajeev	10 - 0	0:22	IPO
F-25	GILBERT DANIEL	1	4	<b>RODRIGUES JUNIOR Lucio Flavio</b>	0 - 10	0:53	IPO
F-37	<b>VENUGOPAL Rajeev</b>	3	5	BERTRAND Jean-Francois	10 - 0	0:00	FUS
F-38	KOSTROVETS VLADIMIR	2	4	<b>RODRIGUES JUNIOR Lucio Flavio</b>	0 - 10	2:09	KIK
F-50	GILBERT DANIEL	1	3	<b>VENUGOPAL Rajeev</b>	0 - 10	1:34	IPO
F-51	KOSTROVETS VLADIMIR	2	5	BERTRAND Jean-Francois			

Résultats/Results

Pos	Nom/Name
1	
2	
3	
4	
5	

# Omnium 2016 4-5 novembre 2016 Montréal Vet M4M5 lourd/heavy

Compétiteurs/Competitors: 5

## Compétiteurs/Competitors

#	Nom/Name	Grade	Club	1	2	3	4	5	G/W	Pts	Pos
1	SHAPORIN IGOR	1D	QC		10		5	10	3	25	2
2	JONES Brian	1k	ON						0	0	5
3	CAGGIANO Rinaldo	4D	NB	1	10		10	10	4	31	1
4	BERNAQUEZ Francois	2D	QC		10			10	2	20	3
5	BOUDREAU Francois	2k	QC		10				1	10	4

## Matches/Matches

Match	Blanc/White			Bleu/Blue	Rés/Res	Tmp/Tim	Code
F-3	<b>BERNAQUEZ Francois</b>	4	5	BOUDREAU Francois	10 - 0	1:48	WIP
F-4	<b>SHAPORIN IGOR</b>	1	2	JONES Brian	10 - 0	0:33	IPO
F-11	<b>CAGGIANO Rinaldo</b>	3	4	BERNAQUEZ Francois	10 - 0	1:12	IPO
F-12	<b>SHAPORIN IGOR</b>	1	5	BOUDREAU Francois	10 - 0	0:24	IPO
F-20	JONES Brian	2	3	<b>CAGGIANO Rinaldo</b>	0 - 10	0:08	IPO
F-21	<b>SHAPORIN IGOR</b>	1	4	BERNAQUEZ Francois	5 - 0	3:00	YUK
F-33	<b>CAGGIANO Rinaldo</b>	3	5	BOUDREAU Francois	10 - 0	0:34	IPO
F-34	JONES Brian	2	4	<b>BERNAQUEZ Francois</b>	0 - 10	0:29	WIP
F-46	SHAPORIN IGOR	1	3	<b>CAGGIANO Rinaldo</b>	0 - 1	3:00	YUS
F-47	JONES Brian	2	5	<b>BOUDREAU Francois</b>	0 - 10	0:59	IPO

## Résultats/Results

Pos	Nom/Name
1	CAGGIANO Rinaldo, NB
2	SHAPORIN IGOR, QC
3	BERNAQUEZ Francois, QC
4	BOUDREAU Francois, QC
5	JONES Brian, ON