

# Omnium 2016 4-5 novembre 2016 Montréal NewazaF Lourd/Heavy

Compétiteurs/Competitors: 2

## Compétiteurs/Competitors

#	Nom/Name	Grade	Club	1	2	1	2	1	2	G/W	Pts	Pos
1	MCALPINE Amanda	2k	ON		5		7			2	12	1
2	KENNEDY-TURNER Kathleen	1k	QC							0	0	2

## Matches/Matches

Match	Blanc/White			Bleu/Blue	Rés/Res	Tmp/Tim	Code
D-74	MCALPINE Amanda	1	2	KENNEDY-TURNER Kathleen	5 - 0	3:00	YUK
D-79	MCALPINE Amanda	1	2	KENNEDY-TURNER Kathleen	7 - 0	1:47	WAZ
D-84	MCALPINE Amanda	1	2	KENNEDY-TURNER Kathleen			

## Résultats/Results

Pos	Nom/Name
1	MCALPINE Amanda, ON
2	KENNEDY-TURNER Kathleen, QC

# Omnium 2016 4-5 novembre 2016 Montréal NewazaM léger/light

Compétiteurs/Competitors: 4

## Compétiteurs/Competitors

#	Nom/Name	Grade	Club	1	2	3	4	G/W	Pts	Pos
1	STAWARZ Cédric	2D	QC		7	7		2	14	2
2	MALLETTE Benoît	2k	QC					0	0	4
3	PARENT John	4D	NB		7			1	7	3
4	MÉNARD Mathieu	1k	ON	5	7	5		3	17	1

## Matches/Matches

Match	Blanc/White			Bleu/Blue	Rés/Res	Tmp/Tim	Code
D-75	<b>STAWARZ Cédric</b>	1	2	MALLETTE Benoît	7 - 0	2:01	WAZ
D-76	PARENT John	3	4	<b>MÉNARD Mathieu</b>	0 - 5	3:00	YUK
D-80	<b>STAWARZ Cédric</b>	1	3	PARENT John	7 - 0	1:33	WAZ
D-81	MALLETTE Benoît	2	4	<b>MÉNARD Mathieu</b>	0 - 7	1:24	WAZ
D-85	STAWARZ Cédric	1	4	<b>MÉNARD Mathieu</b>	0 - 5	3:00	YUK
D-86	MALLETTE Benoît	2	3	<b>PARENT John</b>	0 - 7	0:37	WAZ

## Résultats/Results

Pos	Nom/Name
1	MÉNARD Mathieu, ON
2	STAWARZ Cédric, QC
3	PARENT John, NB
4	MALLETTE Benoît, QC

Compétiteurs/Competitors

#	Nom/Name	Grade	Club	1	2	3	4	G/W	Pts	Pos
1	CHAN Justin	2D	ON		5			1	5	3
2	GUERRA Andre	3k	ON					0	0	4
3	DAVIDSON Stephen	1D	NB	7	7		7	3	21	1
4	HIRAO Joichi	4D	JPN	7	7			2	14	2

Matches/Matches

Match	Blanc/White			Bleu/Blue	Rés/Res	Tmp/Tim	Code
D-72	<b>CHAN Justin</b>	1	2	GUERRA Andre	5 - 0	1:54	YUK
D-73	<b>DAVIDSON Stephen</b>	3	4	HIRAO Joichi	7 - 0	0:00	WAZ
D-77	CHAN Justin	1	3	<b>DAVIDSON Stephen</b>	0 - 7	3:00	WAZ
D-78	GUERRA Andre	2	4	<b>HIRAO Joichi</b>	0 - 7	1:22	WAZ
D-82	CHAN Justin	1	4	<b>HIRAO Joichi</b>	0 - 7	1:35	WAZ
D-83	GUERRA Andre	2	3	<b>DAVIDSON Stephen</b>	0 - 7	1:20	WAZ

Résultats/Results

Pos	Nom/Name
1	DAVIDSON Stephen , NB
2	HIRAO Joichi, JPN
3	CHAN Justin, ON
4	GUERRA Andre, ON

# Omnium 2016 4-5 novembre 2016 Montréal U14F -36

Compétiteurs/Competitors: 7

## Compétiteurs/Competitors A

#	Nom/Name	Grade	Club	1	2	3	4	G/W	Pts	Pos
1	CALTAGIRONE ALISSA	2k	USA			10	10	2	20	2
2	TOSHKOV Catherine	3k	QC	10		10	10	3	30	1
3	TRUDEL Flavie	3k	QC					0	0	4
4	MEZHERITSKY Naomi	3k	ON			10		1	10	3

## Matches/Matches A

Match	Blanc/White	Bleu/Blue	Rés/Res	Tmp/Tim	Code
F-49	CALTAGIRONE ALISSA 1 2	TOSHKOV Catherine	0 - 10	1:20	IPO
F-50	TRUDEL Flavie 3 4	MEZHERITSKY Naomi	0 - 10	0:15	WIP
F-65	CALTAGIRONE ALISSA 1 3	TRUDEL Flavie	10 - 0	0:07	IPO
F-66	TOSHKOV Catherine 2 4	MEZHERITSKY Naomi	10 - 0	1:10	WIP
B-1	CALTAGIRONE ALISSA 1 4	MEZHERITSKY Naomi	10 - 0	2:01	IPO
B-2	TOSHKOV Catherine 2 3	TRUDEL Flavie	10 - 0	0:07	IPO

## Compétiteurs/Competitors B

#	Nom/Name	Grade	Club	5	6	7	G/W	Pts	Pos
5	BONIN Ariane	3k	QC				0	0	3
6	BOUYSSOU Celine	2k	USA	10		10	2	20	1
7	ENMAN Lydia	3k+	PE	10			1	10	2

## Matches/Matches B

Match	Blanc/White	Bleu/Blue	Rés/Res	Tmp/Tim	Code
F-51	BONIN Ariane 5 6	BOUYSSOU Celine	0 - 10	0:00	WIP
F-67	BONIN Ariane 5 7	ENMAN Lydia	0 - 10	0:12	IPO
B-3	BOUYSSOU Celine 6 7	ENMAN Lydia	10 - 0	1:03	IPO

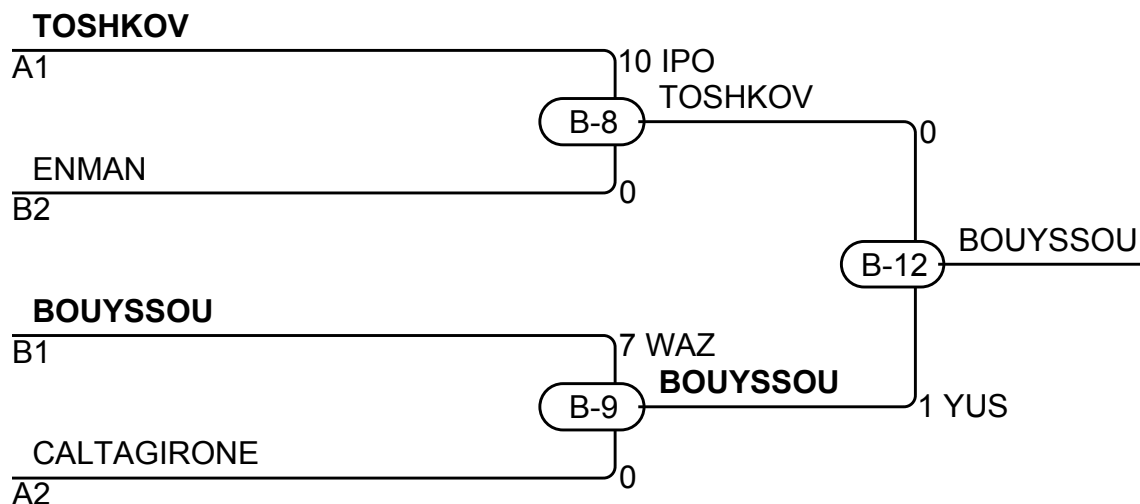

## Résultats/Results

Pos	Nom/Name
1	BOUYSSOU Celine, USA
2	TOSHKOV Catherine, QC
3	ENMAN Lydia, PE
3	CALTAGIRONE ALISSA, USA

# Omnium 2016 4-5 novembre 2016 Montréal U14F -40

Compétiteurs/Competitors: 5

## Compétiteurs/Competitors

#	Nom/Name	Grade	Club	1	2	3	4	5	G/W	Pts	Pos
1	SEMYROZUM Anastasiya	3k	QC		10	1		10	3	21	2
2	AYOTTE GABRIELLE	3k+	NB					10	1	10	4
3	SAVOIE Mahée	3k+	NB		10			1	2	11	3
4	MANAILA Rebeca	3k	QC	10	10	10		10	4	40	1
5	LAPOINTE Sophie	3k+	QC						0	0	5

## Matches/Matches

Match	Blanc/White			Bleu/Blue	Rés/Res	Tmp/Tim	Code
E-34	<b>MANAILA Rebeca</b>	4	5	LAPOINTE Sophie	10 - 0	0:51	IPO
E-35	<b>SEMYROZUM Anastasiya</b>	1	2	AYOTTE GABRIELLE	10 - 0	1:19	IPO
E-53	SAVOIE Mahée	3	4	<b>MANAILA Rebeca</b>	0 - 10	0:35	IPO
E-54	<b>SEMYROZUM Anastasiya</b>	1	5	LAPOINTE Sophie	10 - 0	0:59	IPO
E-62	AYOTTE GABRIELLE	2	3	<b>SAVOIE Mahée</b>	0 - 10	1:25	IPO
E-63	SEMYROZUM Anastasiya	1	4	<b>MANAILA Rebeca</b>	0 - 10	1:03	WIP
E-75	<b>SAVOIE Mahée</b>	3	5	LAPOINTE Sophie	1 - 0	3:00	YUS
E-76	AYOTTE GABRIELLE	2	4	<b>MANAILA Rebeca</b>	0 - 10	1:32	IPO
E-88	<b>SEMYROZUM Anastasiya</b>	1	3	SAVOIE Mahée	1 - 0	3:00	YUS
E-89	<b>AYOTTE GABRIELLE</b>	2	5	LAPOINTE Sophie	10 - 0	0:08	IPO

## Résultats/Results

Pos	Nom/Name
1	MANAILA Rebeca, QC
2	SEMYROZUM Anastasiya , QC
3	SAVOIE Mahée, NB
4	AYOTTE GABRIELLE, NB
5	LAPOINTE Sophie, QC

# Omnium 2016 4-5 novembre 2016 Montréal U14F -44

Compétiteurs/Competitors: 2

## Compétiteurs/Competitors

#	Nom/Name	Grade	Club	1	2	1	2	1	2	G/W	Pts	Pos
1	CHARNEAU Adèle	3k	QC		10		5			2	15	1
2	IKENE Ioundja	3k	QC							0	0	2

## Matches/Matches

Match	Blanc/White			Bleu/Blue	Rés/Res	Tmp/Tim	Code
F-60	CHARNEAU Adèle	1	2	IKENE Ioundja	10 - 0	1:21	IPO
F-78	CHARNEAU Adèle	1	2	IKENE Ioundja	5 - 0	3:00	YUK
F-94	CHARNEAU Adèle	1	2	IKENE Ioundja			

## Résultats/Results

Pos	Nom/Name
1	CHARNEAU Adèle, QC
2	IKENE Ioundja, QC

# Omnium 2016 4-5 novembre 2016 Montréal U14F -48

Compétiteurs/Competitors: 4

## Compétiteurs/Competitors

#	Nom/Name	Grade	Club	1	2	3	4	G/W	Pts	Pos
1	JENSEN Cassandra	2k	YT			7		1	7	4
2	HORAK LEONARDA	3k+	QC	10		10		2	20	2
3	LEBLANC Marie-Ève	3k+	NB				10	1	10	3
4	HATTENDORF SKYLER	1k	USA	10	10			2	20	1

## Matches/Matches

Match	Blanc/White			Bleu/Blue	Rés/Res	Tmp/Tim	Code
F-52	JENSEN Cassandra	1	2	<b>HORAK LEONARDA</b>	0 - 10	0:10	IPO
F-53	<b>LEBLANC Marie-Ève</b>	3	4	HATTENDORF SKYLER	10 - 0	1:37	HAN
F-68	<b>JENSEN Cassandra</b>	1	3	LEBLANC Marie-Ève	7 - 0	3:00	WAZ
F-69	HORAK LEONARDA	2	4	<b>HATTENDORF SKYLER</b>	0 - 10	0:12	IPO
B-4	JENSEN Cassandra	1	4	<b>HATTENDORF SKYLER</b>	0 - 10	0:18	IPO
B-5	<b>HORAK LEONARDA</b>	2	3	LEBLANC Marie-Ève	10 - 0	0:57	IPO

## Résultats/Results

Pos	Nom/Name
1	HATTENDORF SKYLER, USA
2	HORAK LEONARDA, QC
3	LEBLANC Marie-Ève, NB
4	JENSEN Cassandra, YT

# Omnium 2016 4-5 novembre 2016 Montréal U14F -52

Compétiteurs/Competitors: 5

## Compétiteurs/Competitors

#	Nom/Name	Grade	Club	1	2	3	4	5	G/W	Pts	Pos
1	KIM KERI	3k+	ON		10	10	10	10	4	40	1
2	MENENDEZ ARIANNA	2k	USA			10	7	5	3	22	2
3	PEDDLE Hailey	2k	NS						0	0	5
4	LINGLEY Brandi	3k+	NB			10			1	10	4
5	FILION Noémie	2k	QC			7	10		2	17	3

## Matches/Matches

Match	Blanc/White			Bleu/Blue	Rés/Res	Tmp/Tim	Code
F-33	LINGLEY Brandi	4	5	FILION Noémie	0 - 10	1:08	WIP
F-34	KIM KERI	1	2	MENENDEZ ARIANNA	10 - 0	0:43	IPO
F-43	PEDDLE Hailey	3	4	LINGLEY Brandi	0 - 10	1:32	IPO
F-44	KIM KERI	1	5	FILION Noémie	10 - 0	1:28	WIP
F-58	MENENDEZ ARIANNA	2	3	PEDDLE Hailey	10 - 0	1:01	IPO
F-59	KIM KERI	1	4	LINGLEY Brandi	10 - 0	0:34	WIP
F-76	PEDDLE Hailey	3	5	FILION Noémie	0 - 7	3:00	WAZ
F-77	MENENDEZ ARIANNA	2	4	LINGLEY Brandi	7 - 0	3:00	WAZ
F-92	KIM KERI	1	3	PEDDLE Hailey	10 - 0	0:12	IPO
F-93	MENENDEZ ARIANNA	2	5	FILION Noémie	5 - 0	3:00	YUK

## Résultats/Results

Pos	Nom/Name
1	KIM KERI, ON
2	MENENDEZ ARIANNA, USA
3	FILION Noémie, QC
4	LINGLEY Brandi, NB
5	PEDDLE Hailey, NS



# U14M -31

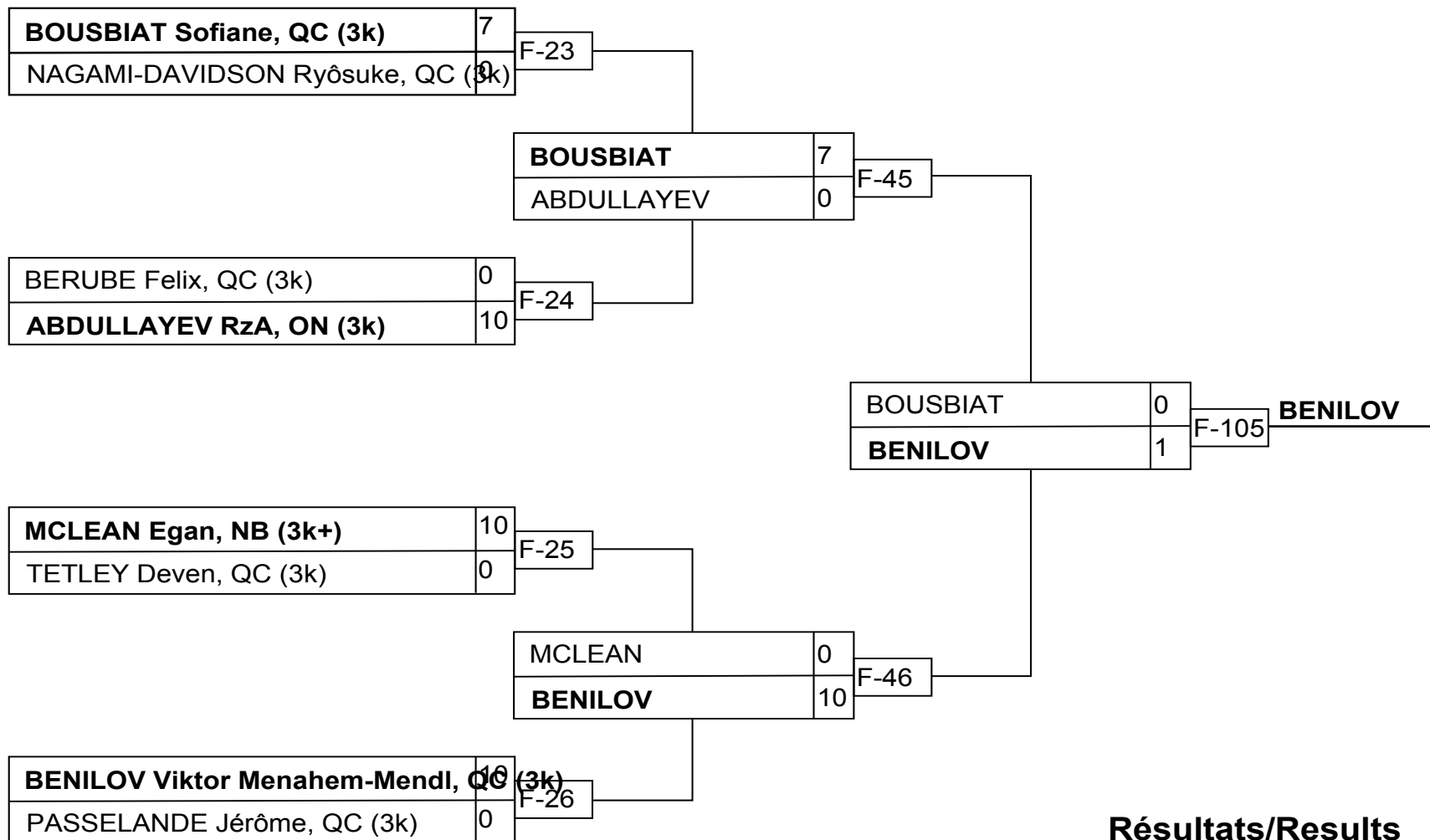

## Résultats/Results

Pos	Nom/Name
1	BENILOV Viktor Menahem-Mendl, QC (3k)
2	BOUSBIAT Sofiane, QC (3k)
3	ABDULLAYEV RzA, ON (3k)
3	NAGAMI-DAVIDSON Ryôsuke, QC (3k)

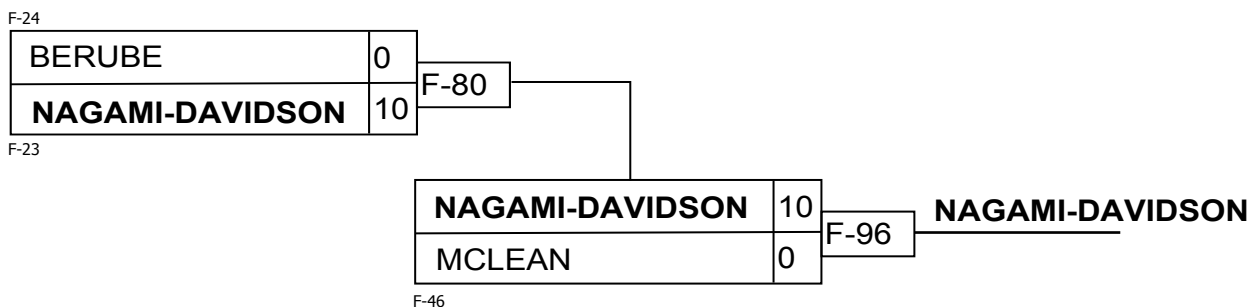
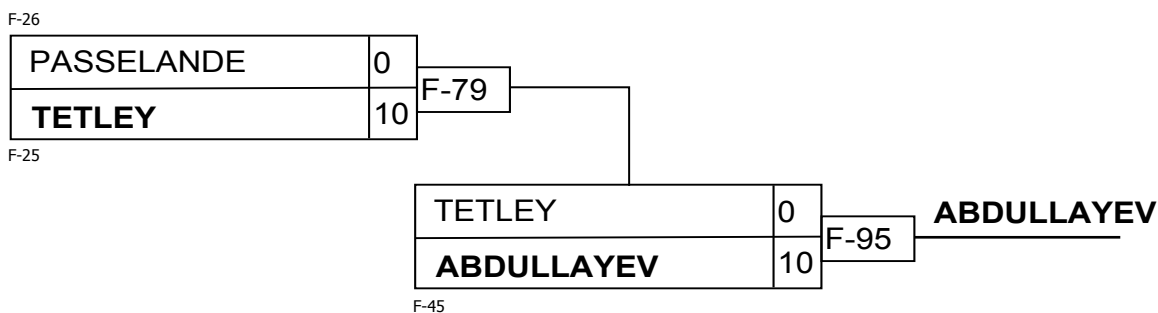

# U14M -34

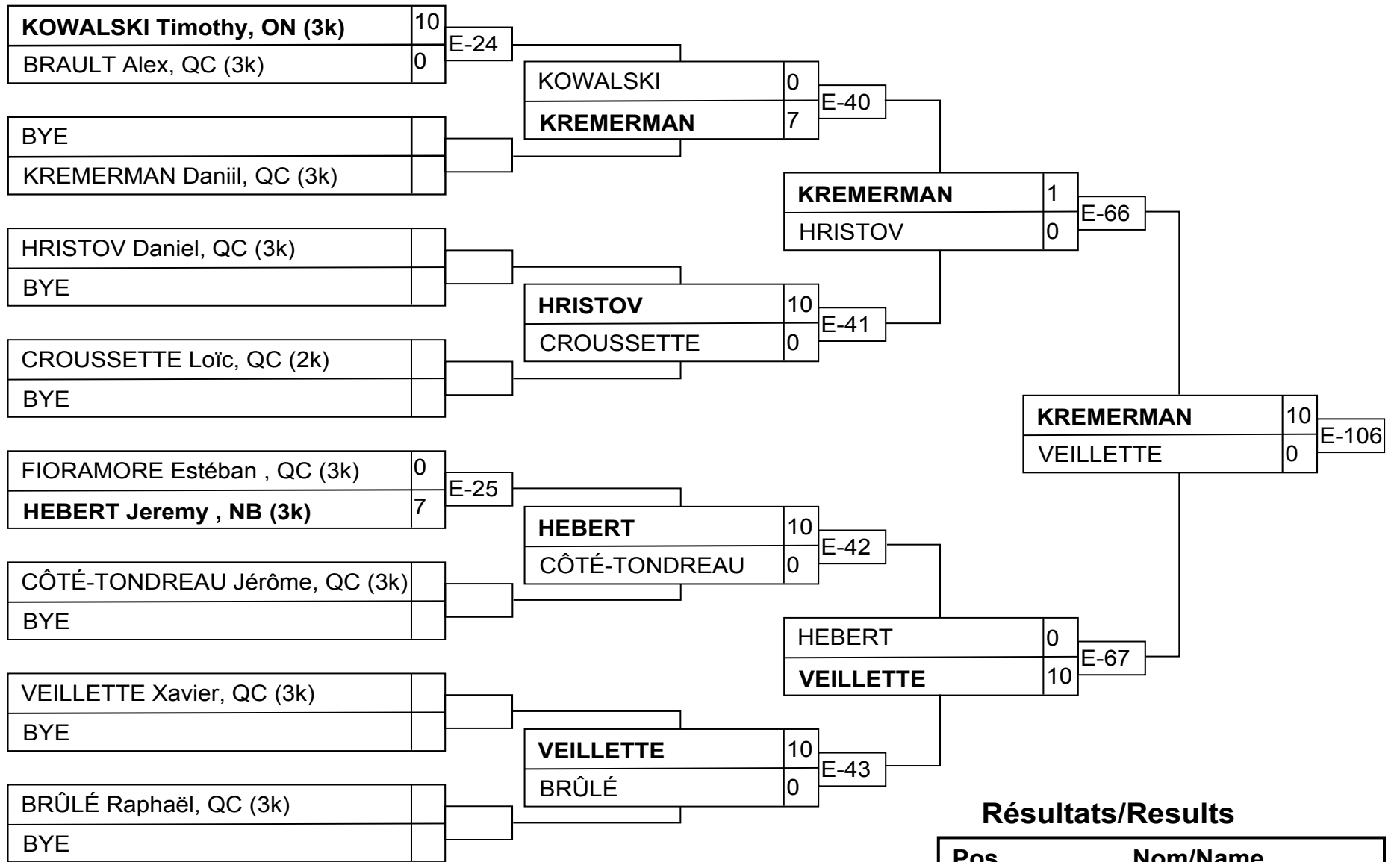

## Résultats/Results

Pos	Nom/Name
1	KREMERMAN Daniil, QC (3k)
2	VEILLETTE Xavier, QC (3k)
3	HRISTOV Daniel, QC (3k)
3	KOWALSKI Timothy, ON (3k)

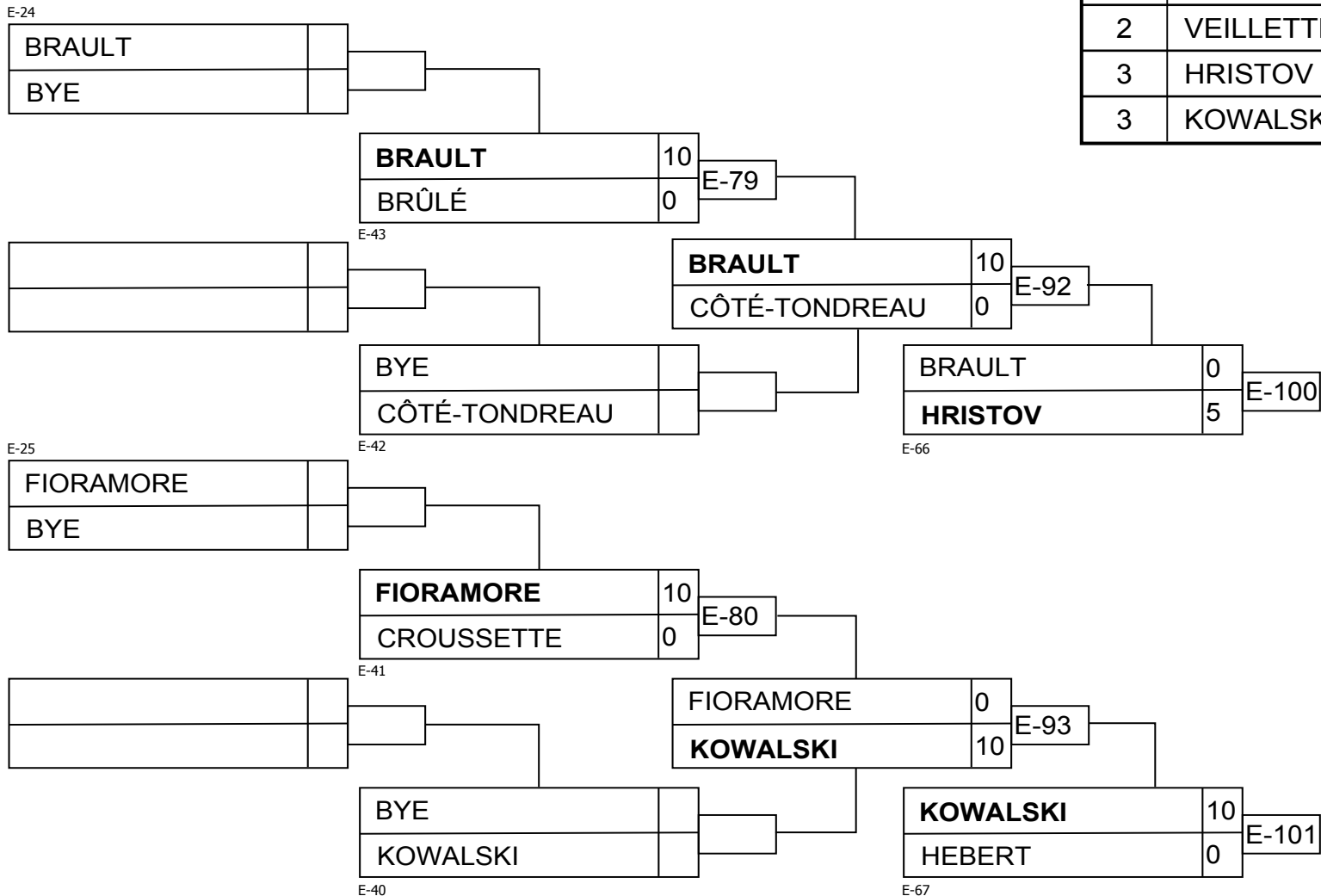

# U14M -38

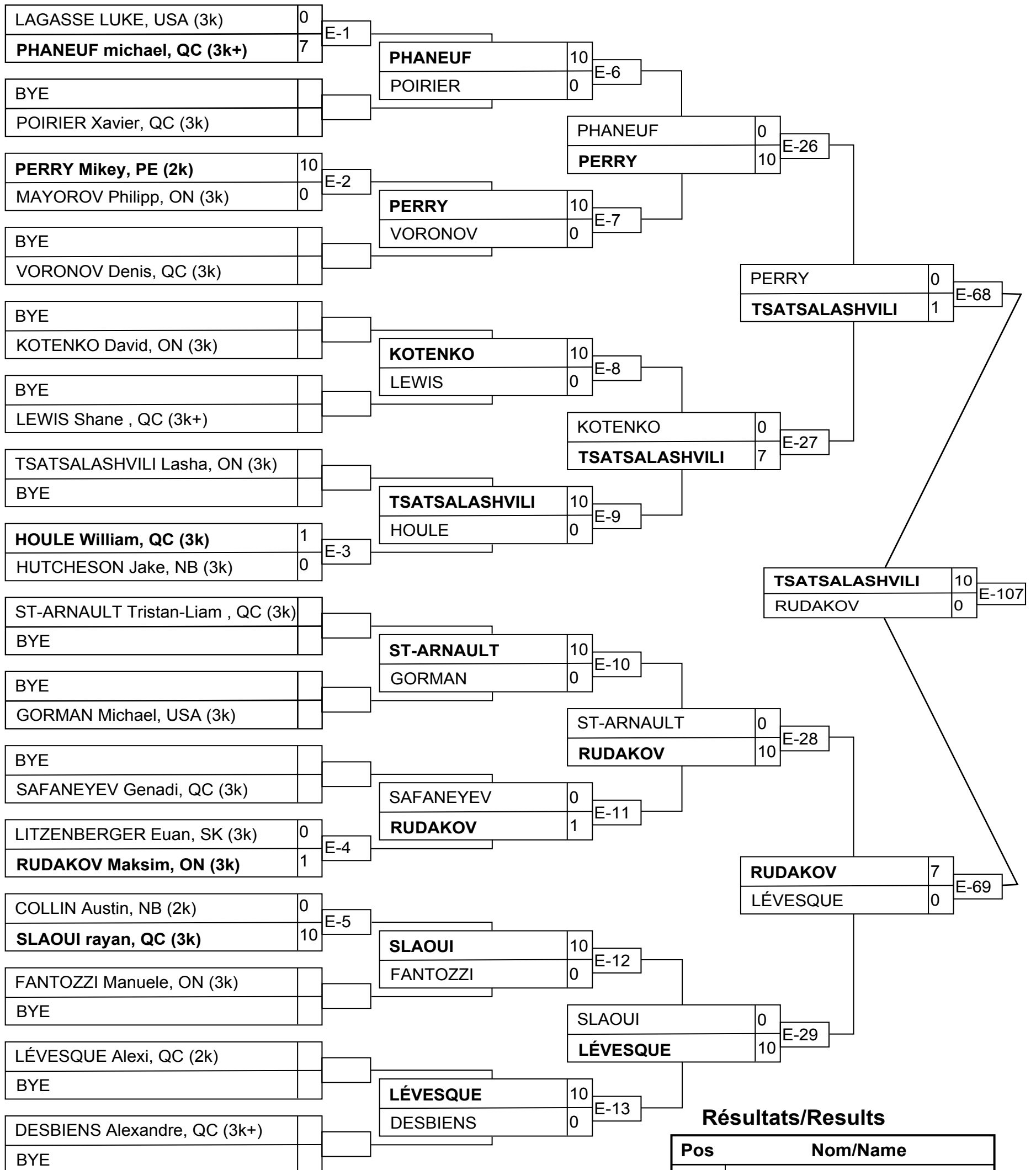

## Résultats/Results

Pos	Nom/Name
1	TSATSALASHVILI Lasha, ON (3k)
2	RUDAKOV Maksim, ON (3k)
3	PERRY Mikey, PE (2k)
3	KOTENKO David, ON (3k)

# U14M -38

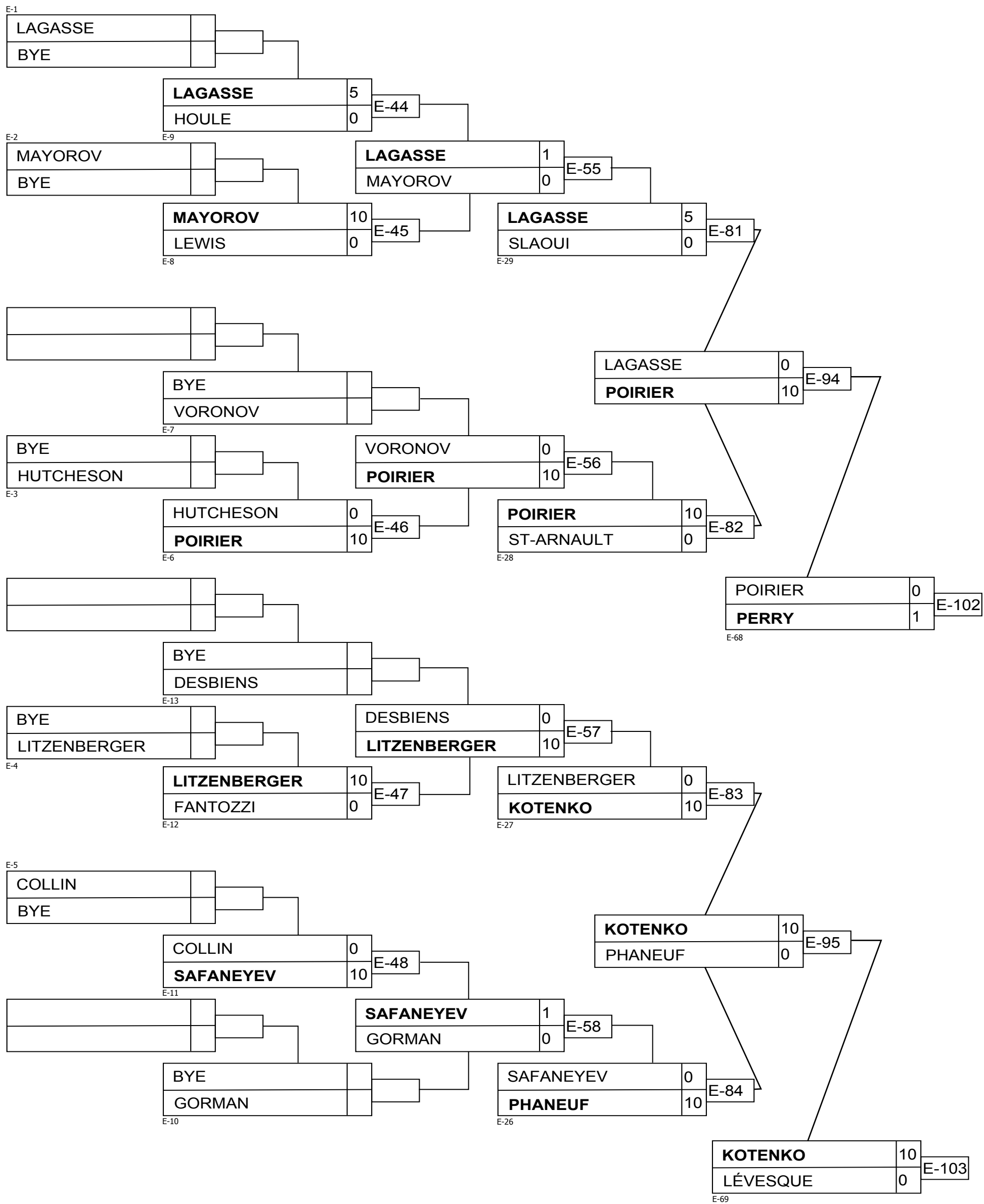

# U14M -42

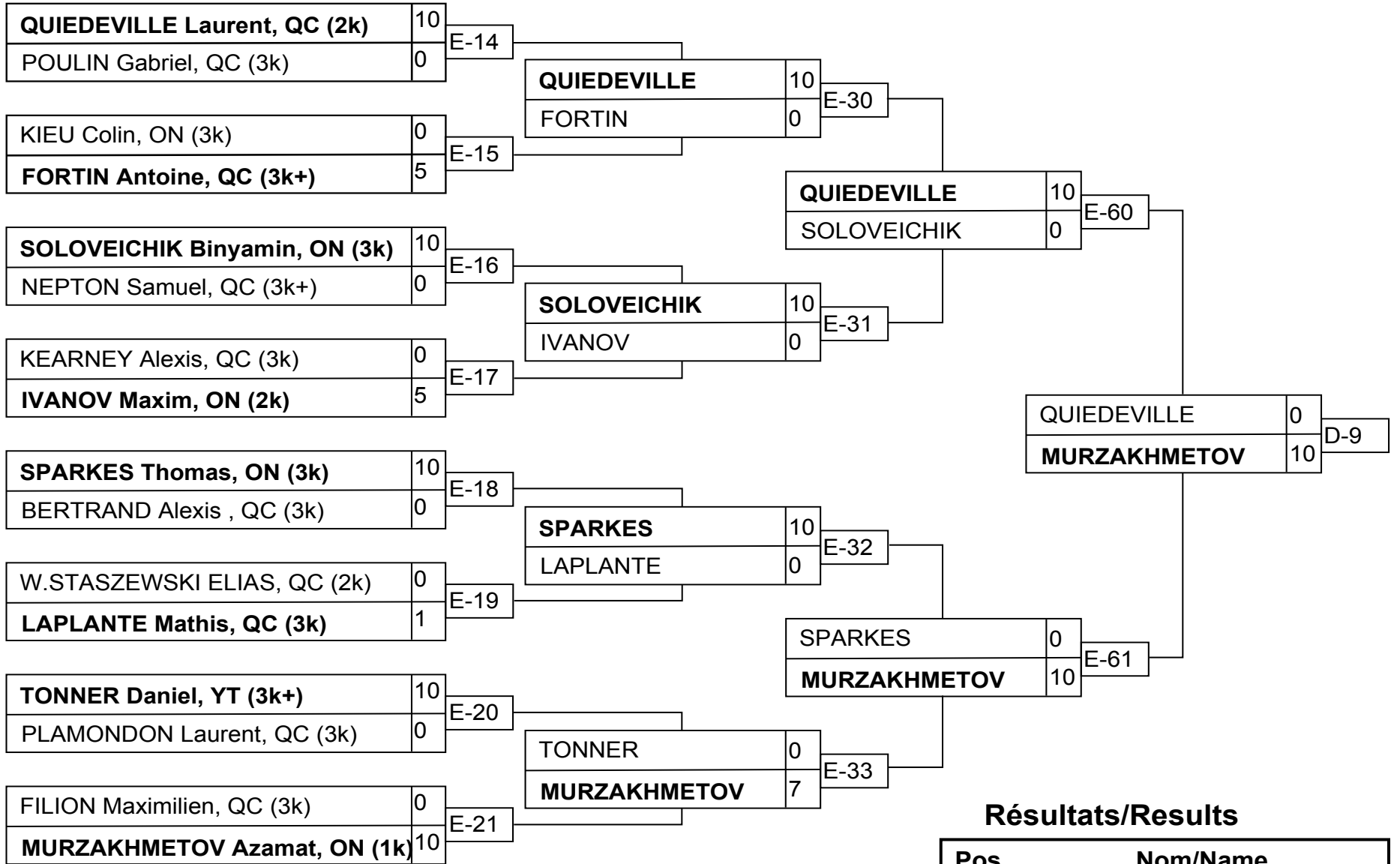

Pos	Nom/Name
1	MURZAKHMETOV Azamat, ON (1k)
2	QUIEDEVILLE Laurent, QC (2k)
3	SOLOVEICHIK Binyamin, ON (3k)
3	SPARKES Thomas, ON (3k)

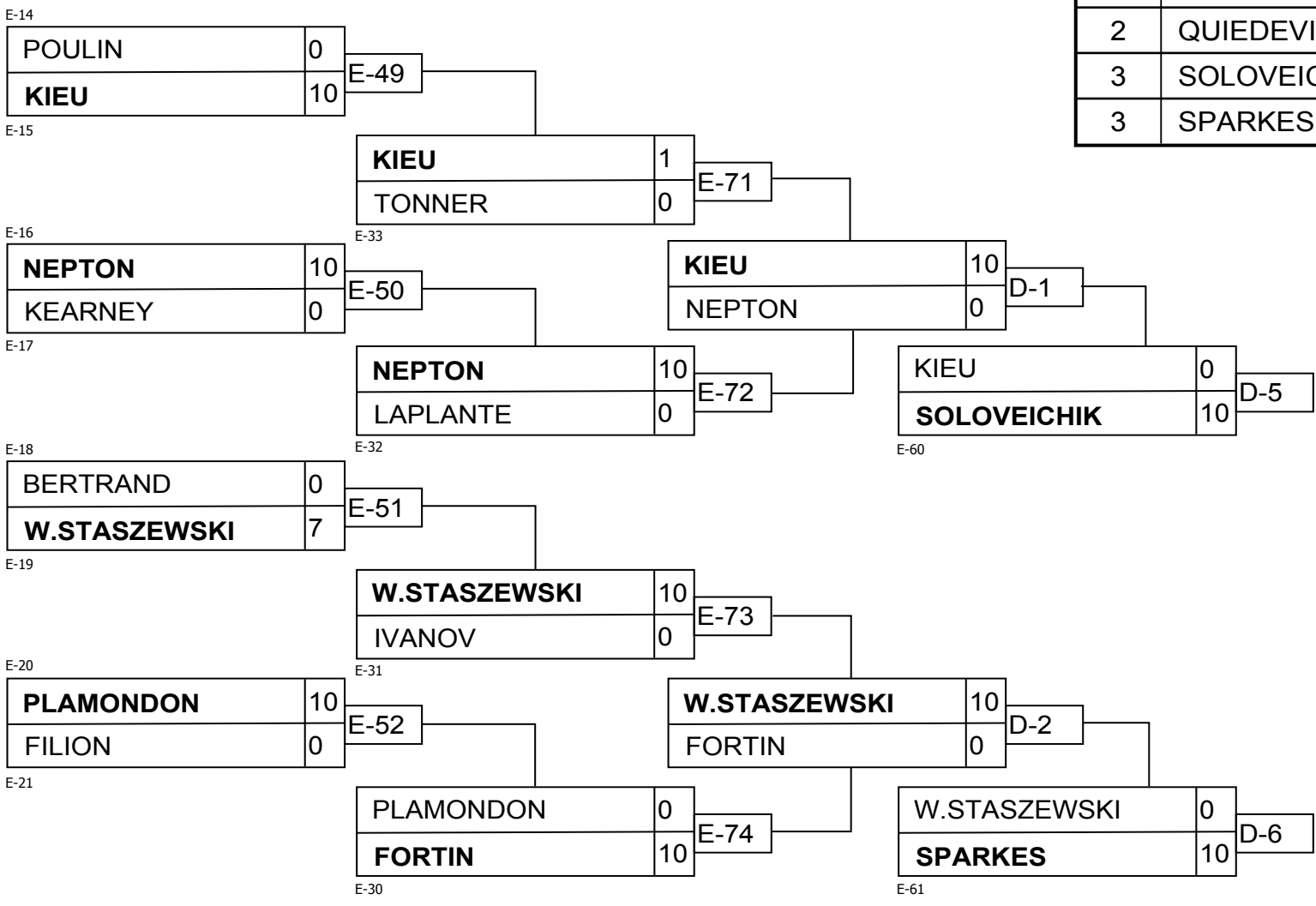

# U14M -46

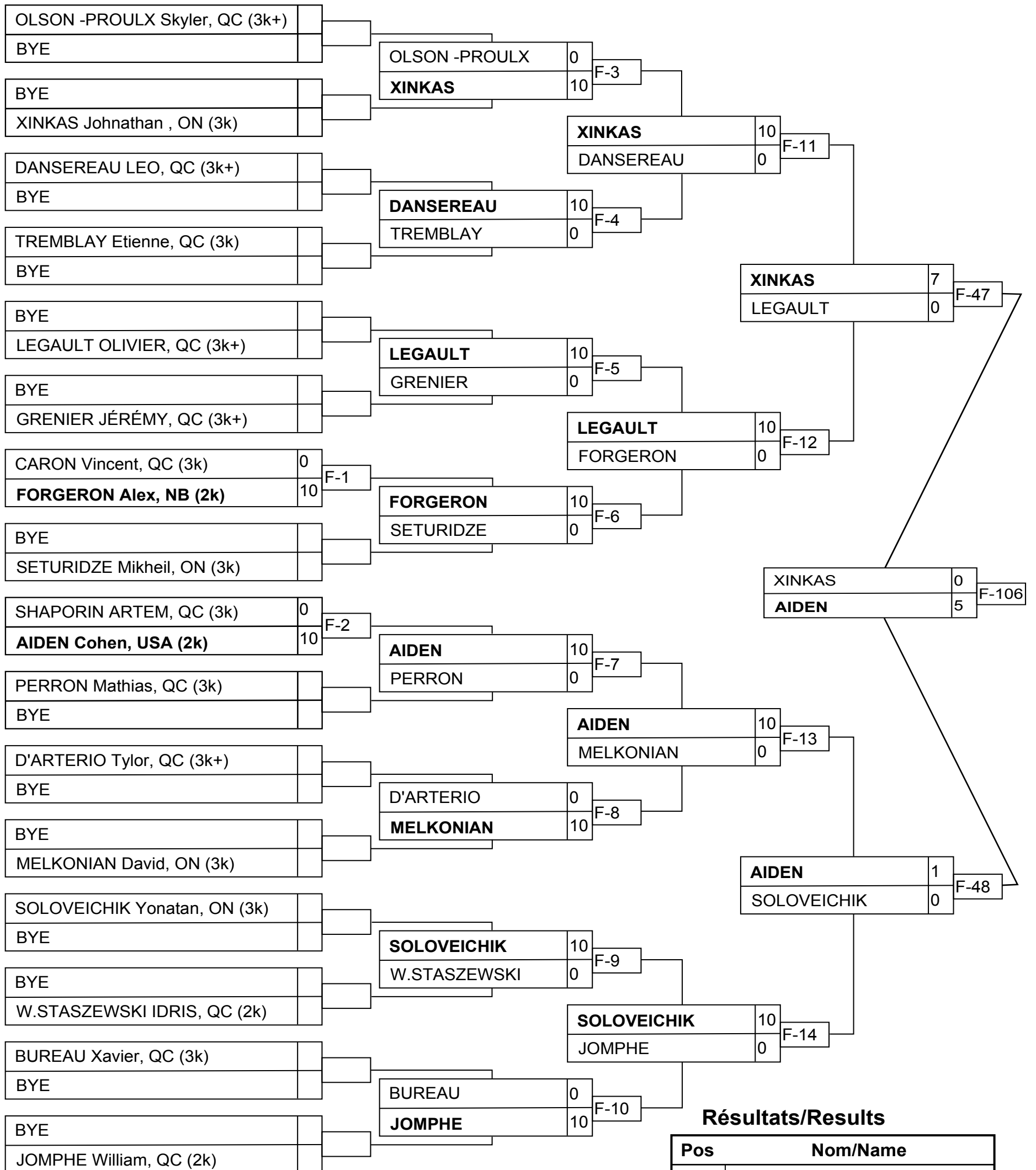

# U14M -46

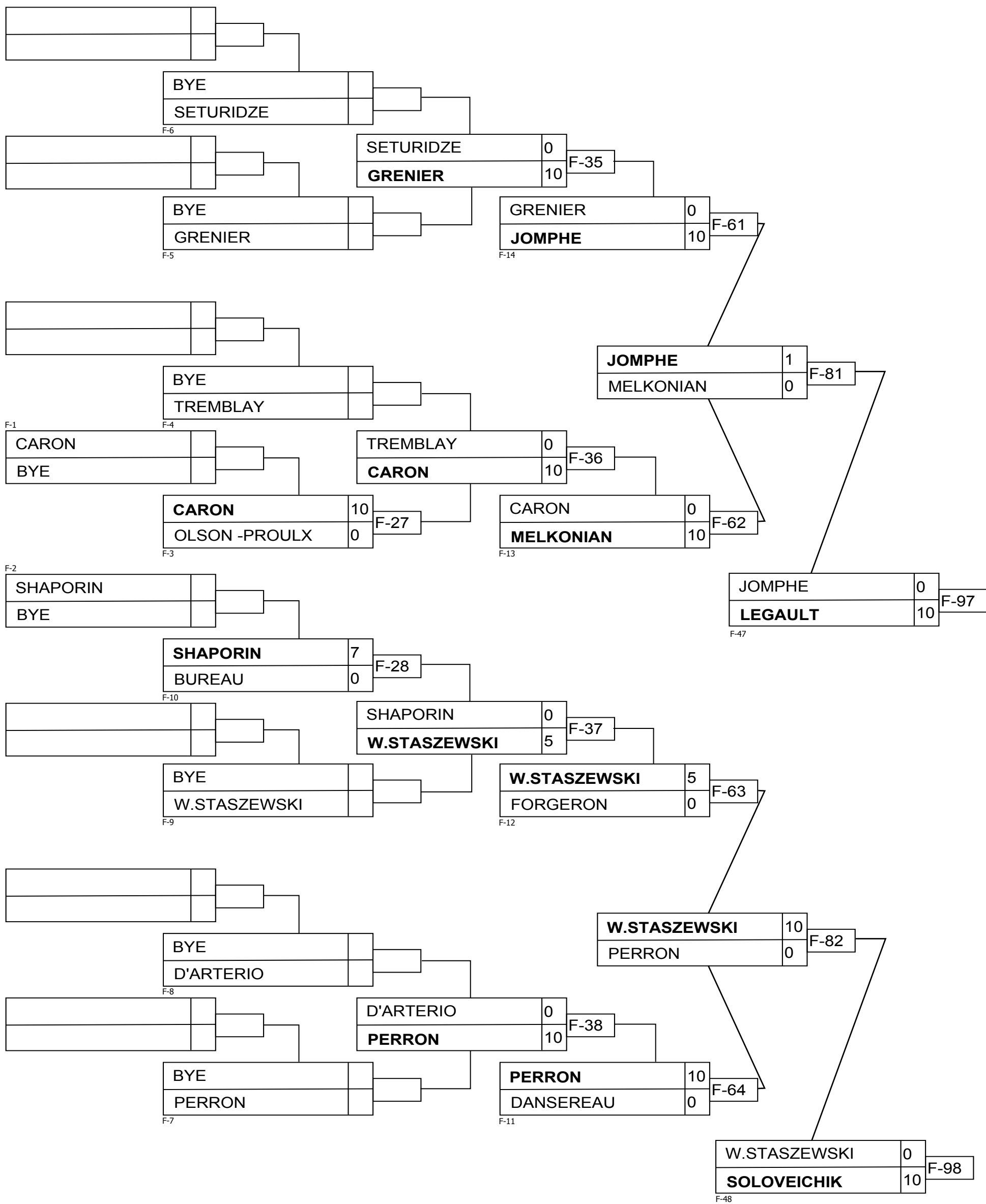

# U14M -50

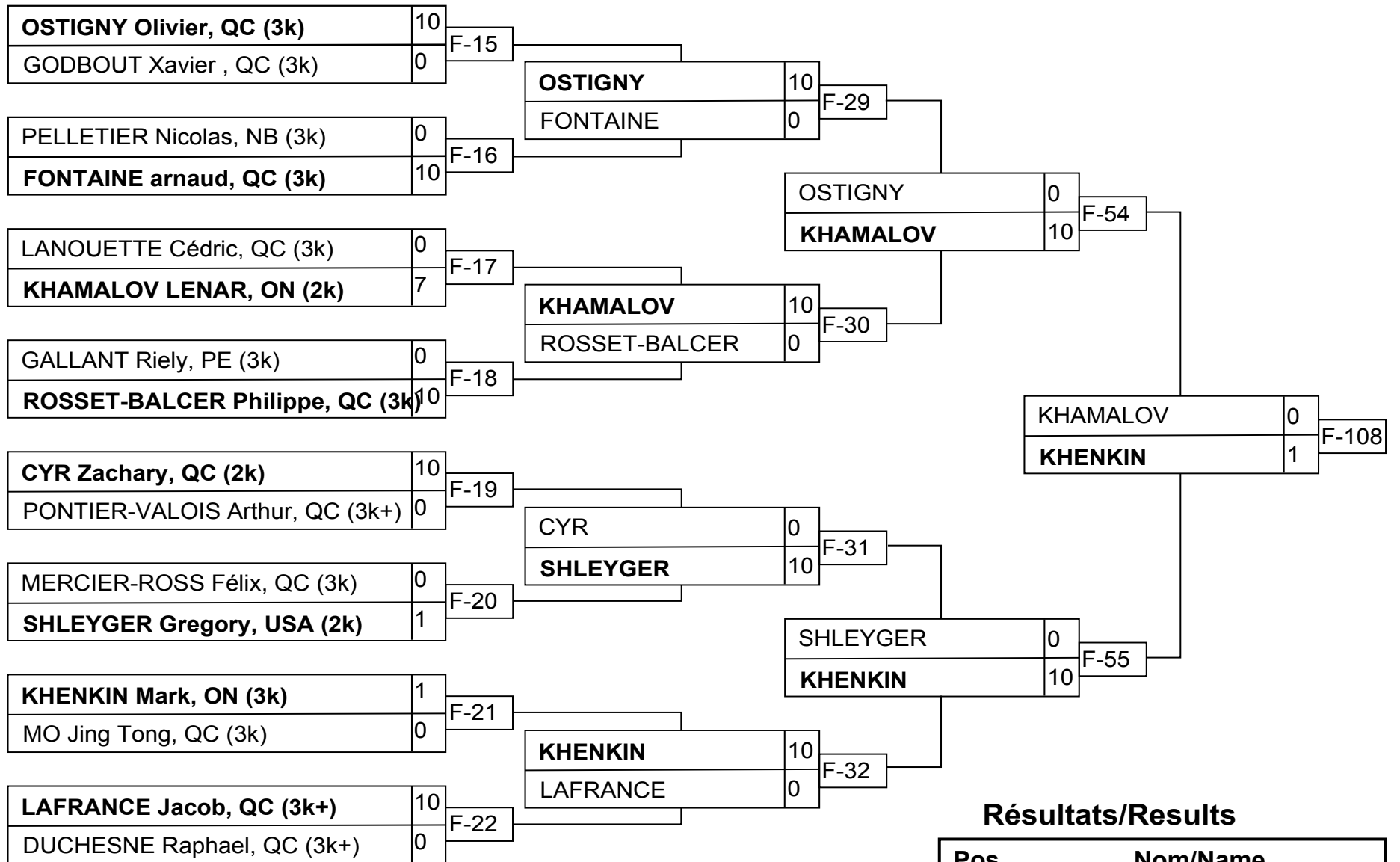

## Résultats/Results

Pos	Nom/Name
1	KHENKIN Mark, ON (3k)
2	KHAMALOV LENAR, ON (2k)
3	CYR Zachary, QC (2k)
3	SHLEYGER Gregory, USA (2k)

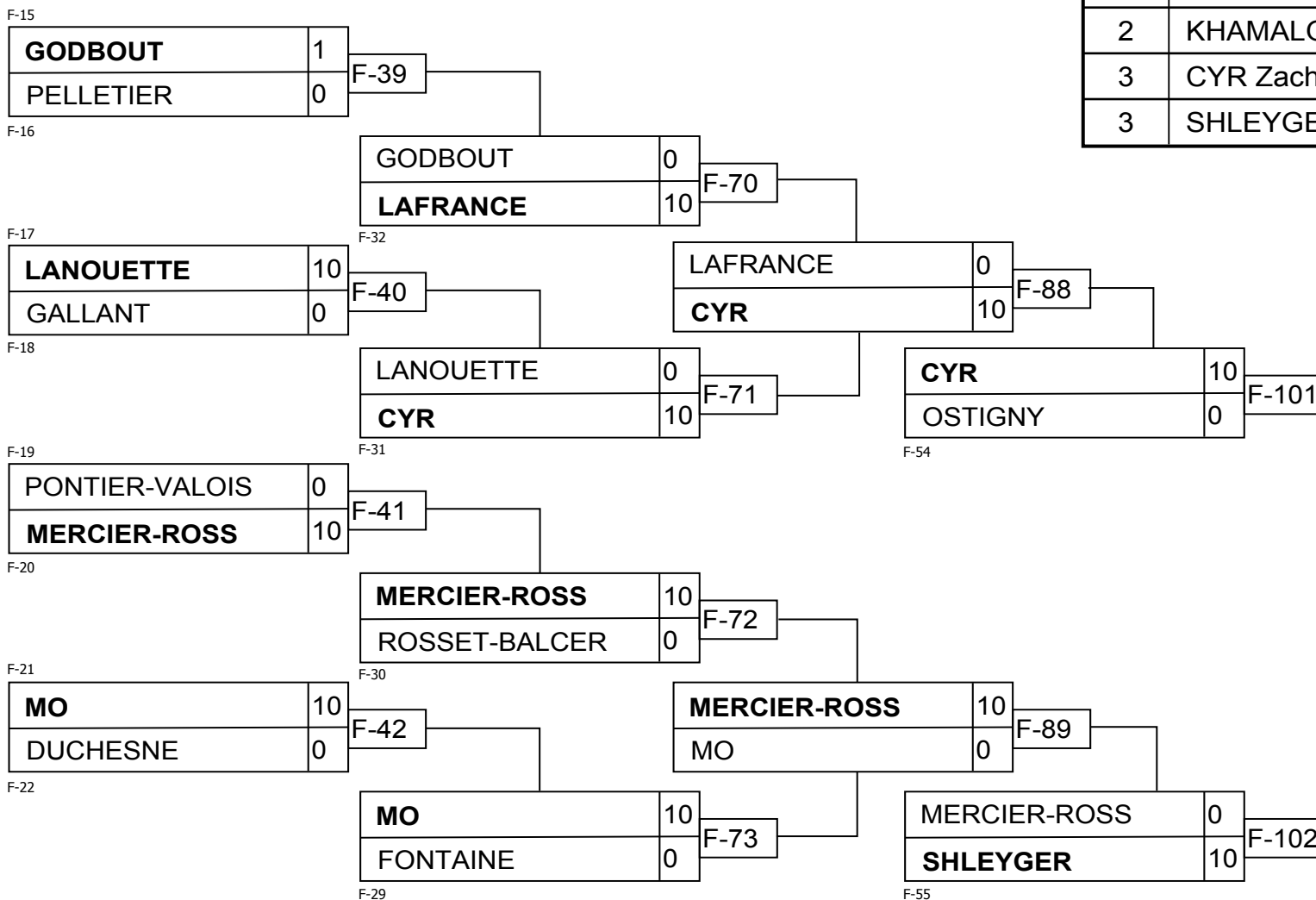



# U14M -55

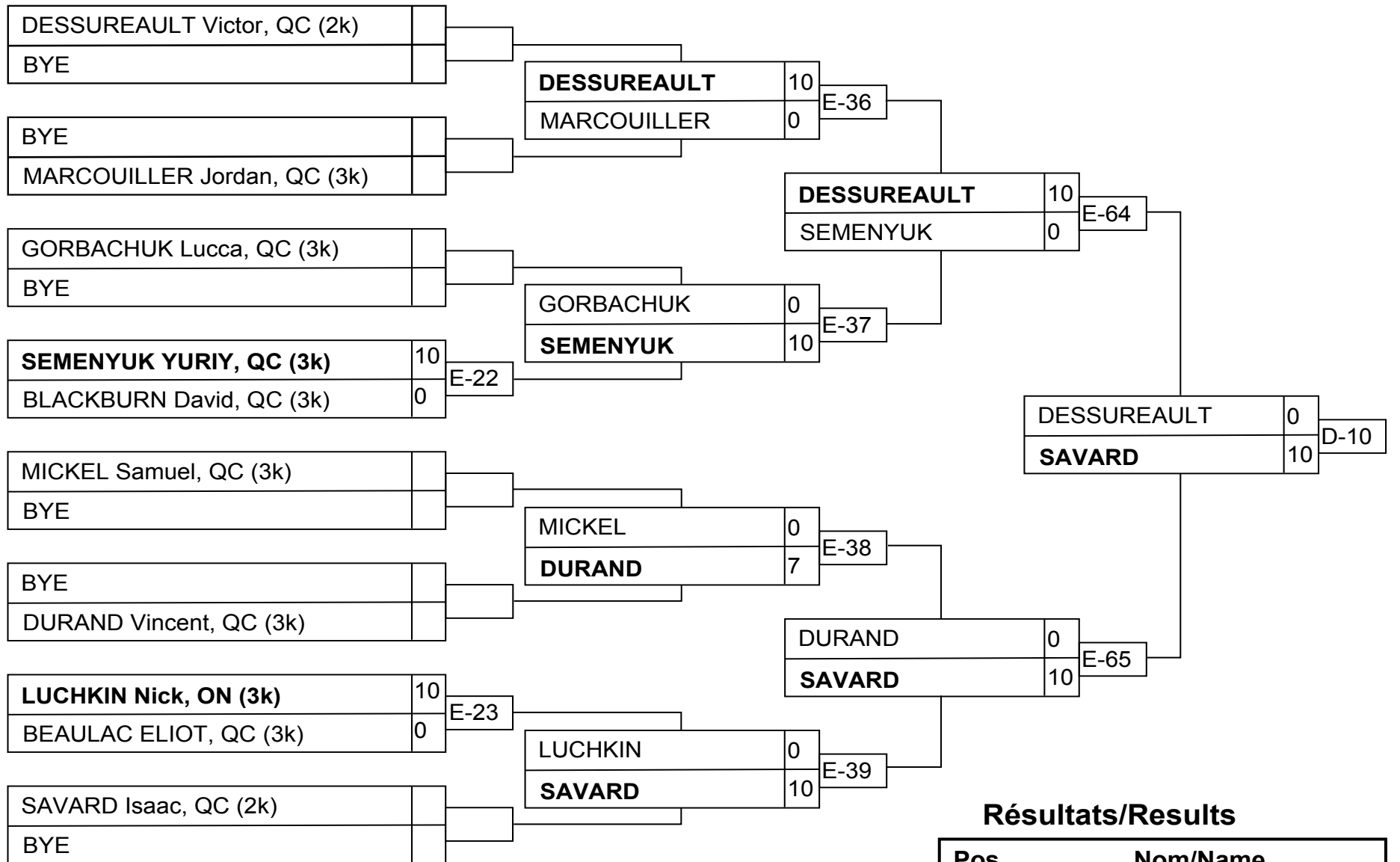

## Résultats/Results

Pos	Nom/Name
1	SAVARD Isaac, QC (2k)
2	DESSUREAULT Victor, QC (2k)
3	LUCHKIN Nick, ON (3k)
3	GORBACHUK Lucca, QC (3k)

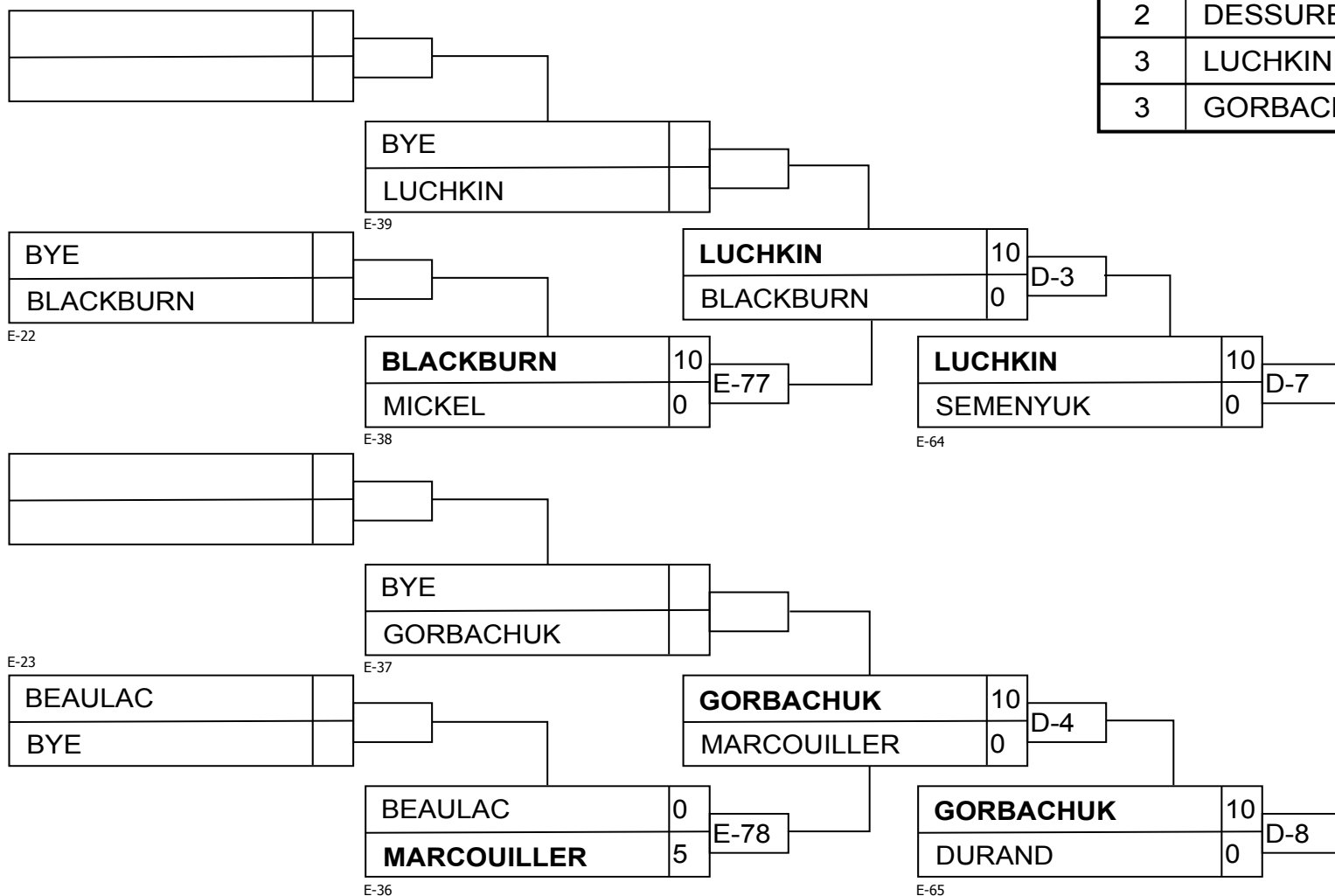

# Omnium 2016 4-5 novembre 2016 Montréal U14M -60

Compétiteurs/Competitors: 6

## Compétiteurs/Competitors A

#	Nom/Name	Grade	Club	1	2	3	G/W	Pts	Pos
1	NGOMBI Jérémie	3k	QC		10	7	2	17	1
2	LAVALLÉE Clément	3k	QC				0	0	3
3	HANJI Guy	3k+	ON		10		1	10	2

## Matches/Matches A

Match	Blanc/White			Bleu/Blue	Rés/Res	Tmp/Tim	Code
F-56	NGOMBI Jérémie	1	2	LAVALLÉE Clément	10 - 0	0:28	WIP
F-74	NGOMBI Jérémie	1	3	HANJI Guy	7 - 0	3:00	WAZ
B-6	LAVALLÉE Clément	2	3	HANJI Guy	0 - 10	1:25	IPO

## Compétiteurs/Competitors B

#	Nom/Name	Grade	Club	4	5	6	G/W	Pts	Pos
4	DURAND Jeremy	3k	QC				0	0	3
5	KARPUKOV Arthur	3k	QC	10		10	2	20	1
6	ANDRIAMANANA Faniry Michael	2k	QC	10			1	10	2

## Matches/Matches B

Match	Blanc/White			Bleu/Blue	Rés/Res	Tmp/Tim	Code
F-57	DURAND Jeremy	4	5	KARPUKOV Arthur	0 - 10	1:29	IPO
F-75	DURAND Jeremy	4	6	ANDRIAMANANA Faniry Michael	0 - 10	1:35	IPO
B-7	KARPUKOV Arthur	5	6	ANDRIAMANANA Faniry Michael	10 - 0	0:00	IPO

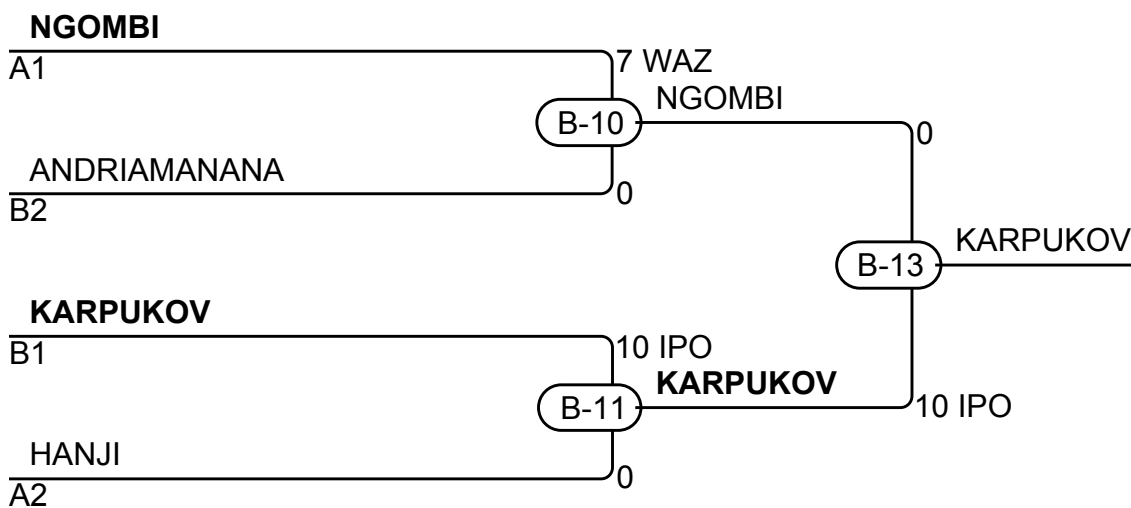

## Résultats/Results

Pos	Nom/Name
1	KARPUKOV Arthur, QC
2	NGOMBI Jérémie, QC
3	ANDRIAMANANA Faniry Michael, QC
3	HANJI Guy, ON

# Omnium 2016 4-5 novembre 2016 Montréal U14M -66

Compétiteurs/Competitors: 3

## Compétiteurs/Competitors

#	Nom/Name	Grade	Club	1	2	3	G/W	Pts	Pos
1	HAMEL Marco	3k	QC				0	0	3
2	BATDORJ Munkhjin	3k	QC	10		10	2	20	1
3	NÉRON Pascal	3k	QC	10			1	10	2

## Matches/Matches

Match	Blanc/White			Bleu/Blue	Rés/Res	Tmp/Tim	Code
E-59	HAMEL Marco	1	2	BATDORJ Munkhjin	0 - 10	0:10	IPO
E-70	HAMEL Marco	1	3	NÉRON Pascal	0 - 10	0:44	WIP
E-85	BATDORJ Munkhjin	2	3	NÉRON Pascal	10 - 0	0:59	IPO

## Résultats/Results

Pos	Nom/Name
1	BATDORJ Munkhjin, QC
2	NÉRON Pascal, QC
3	HAMEL Marco, QC

# Omnium 2016 4-5 novembre 2016 Montréal U16F +70

Compétiteurs/Competitors: 5

## Compétiteurs/Competitors

#	Nom/Name	Grade	Club	1	2	3	4	5	G/W	Pts	Pos
1	DOUGLAS Asia	1k	ON		10	10	10	10	4	40	1
2	DESBIENS Sara	3k	QC			10		10	2	20	3
3	THIBODEAU Maude	3k	NB						0	0	5
4	ARCHAMBAULT Audrey	2k	QC		10	10		10	3	30	2
5	LEFEBVRE Elodie	3k	QC			10			1	10	4

## Matches/Matches

Match	Blanc/White			Bleu/Blue	Rés/Res	Tmp/Tim	Code
D-32	<b>ARCHAMBAULT Audrey</b>	4	5	LEFEBVRE Elodie	10 - 0	0:45	WIP
D-33	<b>DOUGLAS Asia</b>	1	2	DESBIENS Sara	10 - 0	0:52	WIP
D-37	THIBODEAU Maude	3	4	<b>ARCHAMBAULT Audrey</b>	0 - 10	1:05	IPO
D-38	<b>DOUGLAS Asia</b>	1	5	LEFEBVRE Elodie	10 - 0	0:14	IPO
D-45	<b>DESBIENS Sara</b>	2	3	THIBODEAU Maude	10 - 0	0:24	WIP
D-46	<b>DOUGLAS Asia</b>	1	4	ARCHAMBAULT Audrey	10 - 0	1:33	WIP
D-53	THIBODEAU Maude	3	5	<b>LEFEBVRE Elodie</b>	0 - 10	0:56	WIP
D-54	DESBIENS Sara	2	4	<b>ARCHAMBAULT Audrey</b>	0 - 10	1:31	IPO
D-61	<b>DOUGLAS Asia</b>	1	3	THIBODEAU Maude	10 - 0	0:12	IPO
D-62	<b>DESBIENS Sara</b>	2	5	LEFEBVRE Elodie	10 - 0	0:58	WIP

## Résultats/Results

Pos	Nom/Name
1	DOUGLAS Asia, ON
2	ARCHAMBAULT Audrey, QC
3	DESBIENS Sara, QC
4	LEFEBVRE Elodie, QC
5	THIBODEAU Maude, NB

# Omnium 2016 4-5 novembre 2016 Montréal U16F -40

Compétiteurs/Competitors: 1

## Compétiteurs/Competitors

#	Nom/Name	Grade	Club	1	G/W	Pts	Pos
1	ZIGIC Nina	3k	MB		0	0	1

## Matches/Matches

Match	Blanc/White	Bleu/Blue	Rés/Res	Tmp/Tim	Code
-------	-------------	-----------	---------	---------	------

## Résultats/Results

Pos	Nom/Name
1	ZIGIC Nina, MB

# Omnium 2016 4-5 novembre 2016 Montréal U16F -44

Compétiteurs/Competitors: 5

## Compétiteurs/Competitors

#	Nom/Name	Grade	Club	1	2	3	4	5	G/W	Pts	Pos
1	MARCHAND Claudie	2k	NB		10	10			2	20	3
2	ZIGIC Nina	3k	MB			10			1	10	4
3	TURCOTTE Béatrice	3k	QC						0	0	5
4	TESANOVIC Ema	2k	AB	10	10	10		10	4	40	1
5	ZHITAREVA Anna	2k	ON	10	10	10			3	30	2

## Matches/Matches

Match	Blanc/White			Bleu/Blue	Rés/Res	Tmp/Tim	Code
A-37	<b>TESANOVIC Ema</b>	4	5	ZHITAREVA Anna	10 - 0	2:39	IPO
A-38	<b>MARCHAND Claudie</b>	1	2	ZIGIC Nina	10 - 0	2:13	WIP
A-45	TURCOTTE Béatrice	3	4	<b>TESANOVIC Ema</b>	0 - 10	0:34	IPO
A-46	MARCHAND Claudie	1	5	<b>ZHITAREVA Anna</b>	0 - 10	0:00	IPO
A-56	<b>ZIGIC Nina</b>	2	3	TURCOTTE Béatrice	10 - 0	1:33	HAN
A-57	MARCHAND Claudie	1	4	<b>TESANOVIC Ema</b>	0 - 10	0:00	IPO
A-73	TURCOTTE Béatrice	3	5	<b>ZHITAREVA Anna</b>	0 - 10	1:41	IPO
A-74	ZIGIC Nina	2	4	<b>TESANOVIC Ema</b>	0 - 10	0:19	IPO
A-84	<b>MARCHAND Claudie</b>	1	3	TURCOTTE Béatrice	10 - 0	0:34	IPO
A-85	ZIGIC Nina	2	5	<b>ZHITAREVA Anna</b>	0 - 10	0:45	IPO

## Résultats/Results

Pos	Nom/Name
1	TESANOVIC Ema, AB
2	ZHITAREVA Anna, ON
3	MARCHAND Claudie, NB
4	ZIGIC Nina, MB
5	TURCOTTE Béatrice, QC

# U16F -48

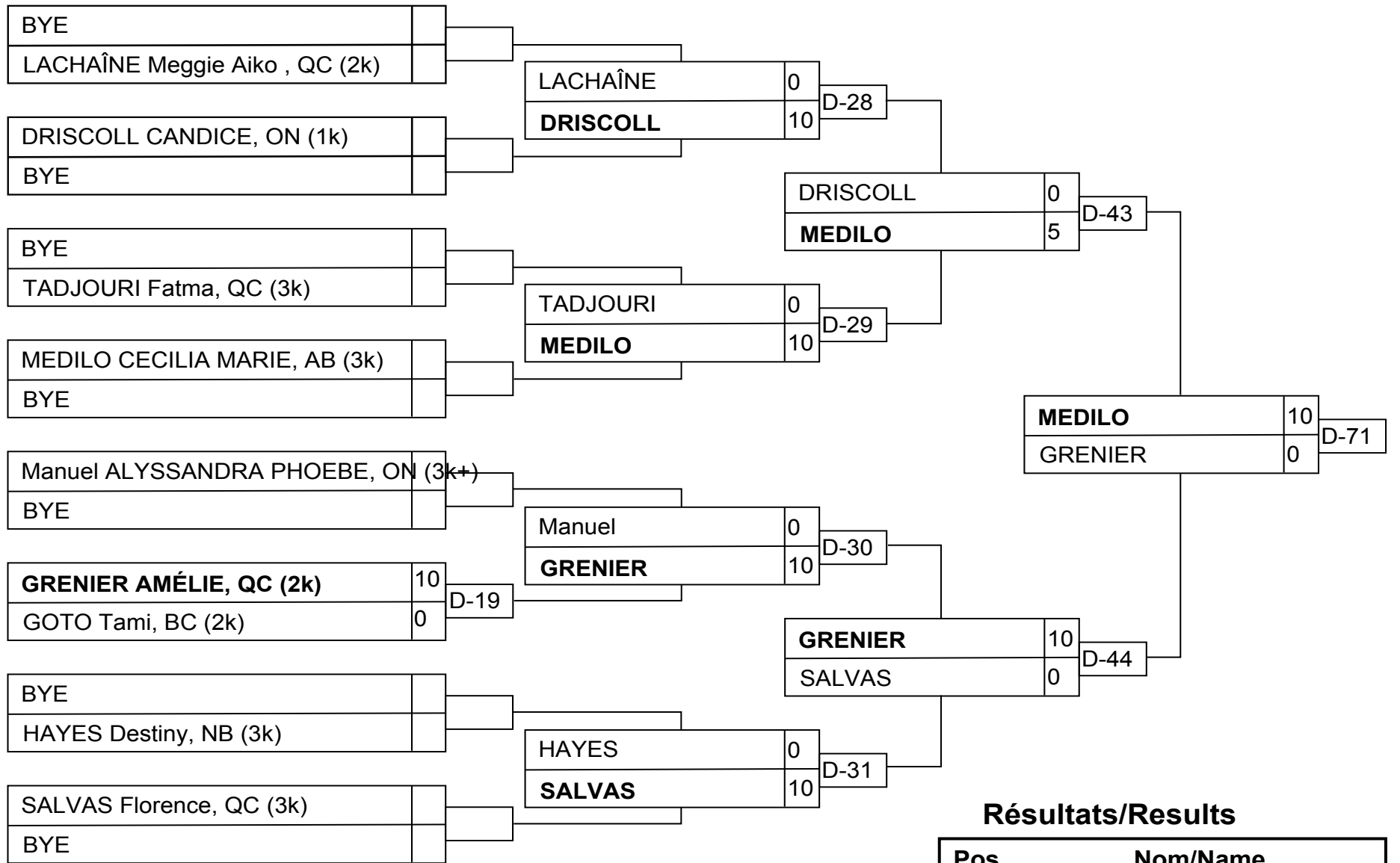

## Résultats/Results

Pos	Nom/Name
1	MEDILO CECILIA MARIE, AB (3k)
2	GRENIER AMÉLIE, QC (2k)
3	DRISCOLL CANDICE, ON (1k)
3	GOTO Tami, BC (2k)

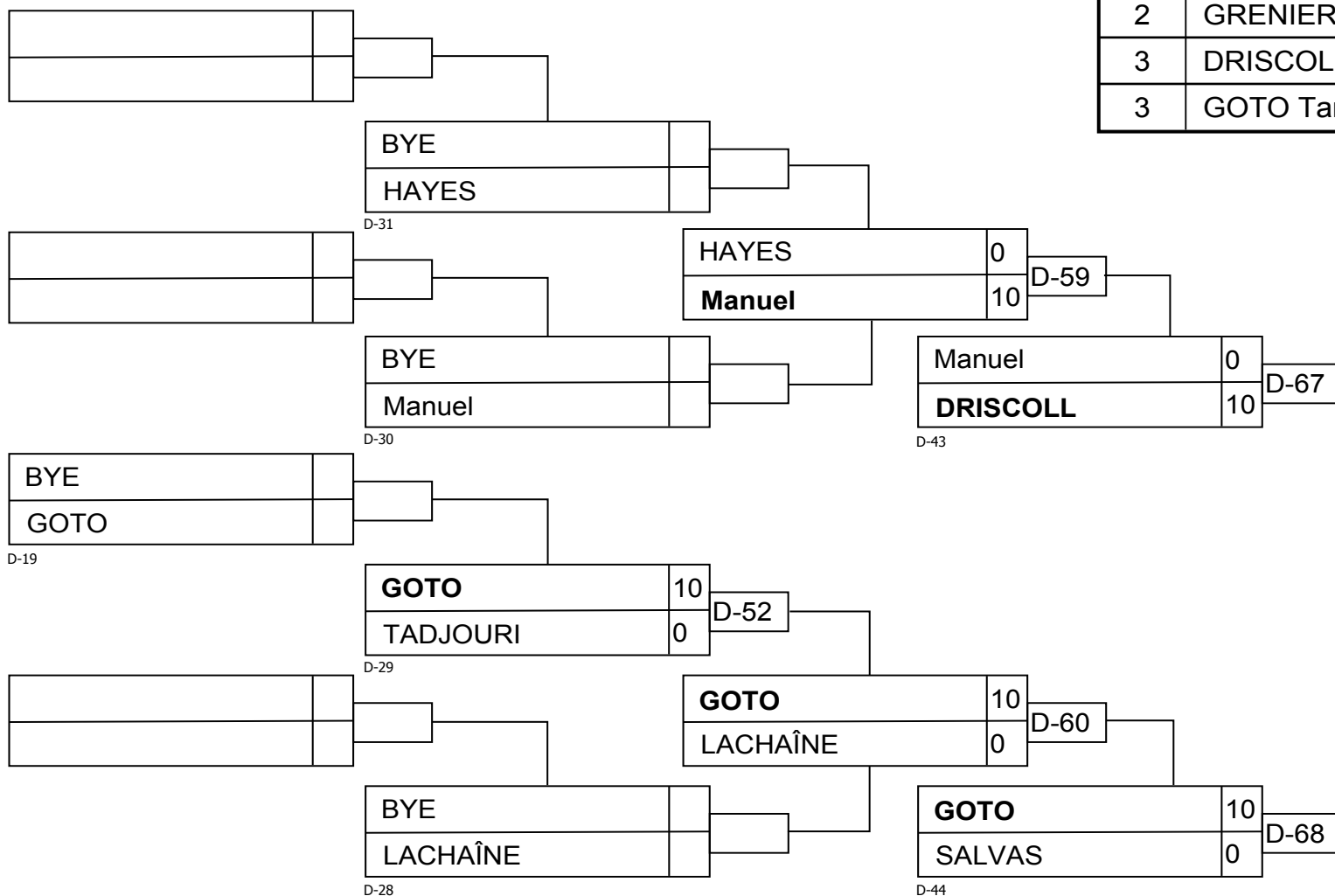

# U16F -52

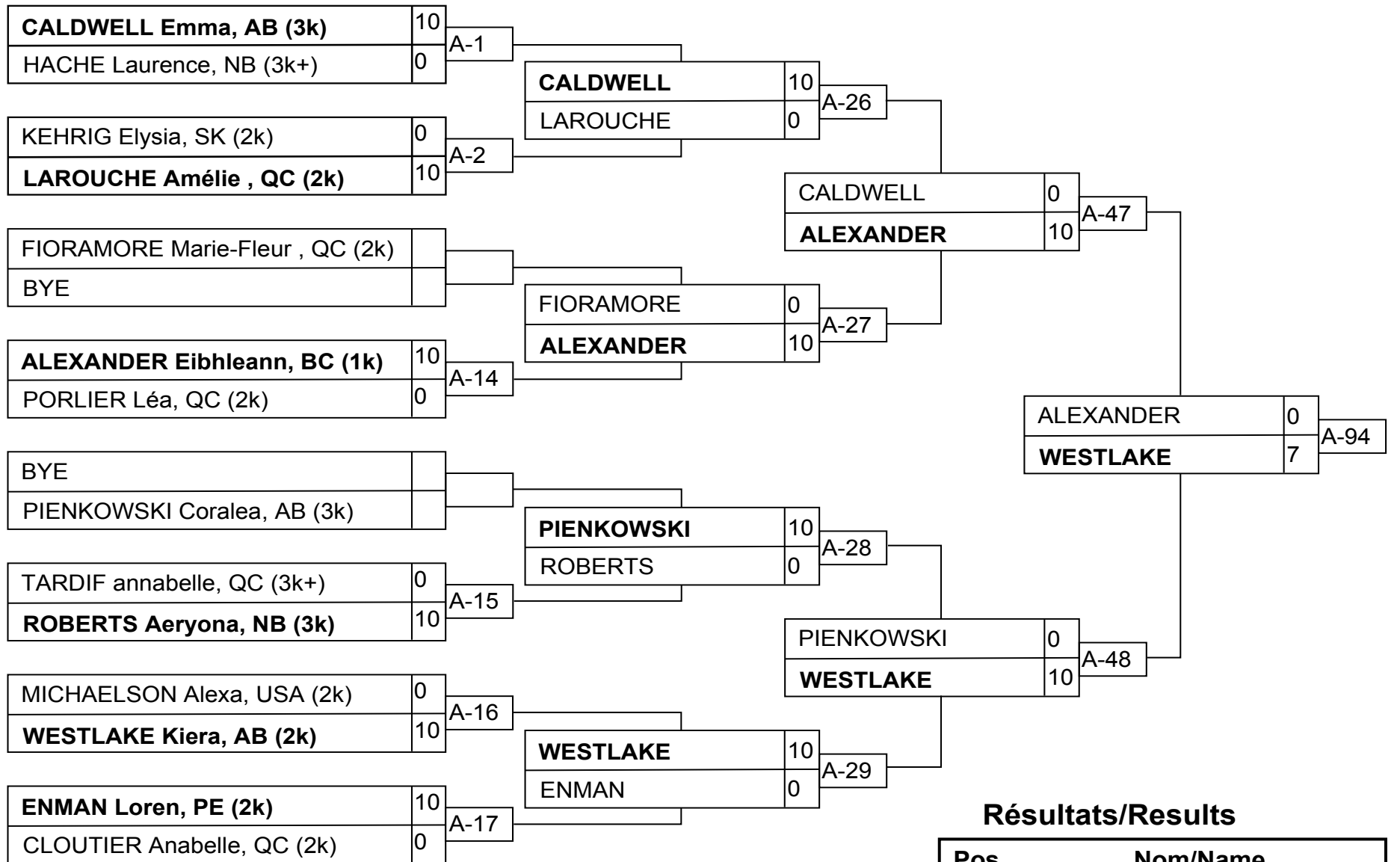

## Résultats/Results

Pos	Nom/Name
1	WESTLAKE Kiera, AB (2k)
2	ALEXANDER Eibhleann, BC (1k)
3	CALDWELL Emma, AB (3k)
3	MICHAELSON Alexa, USA (2k)

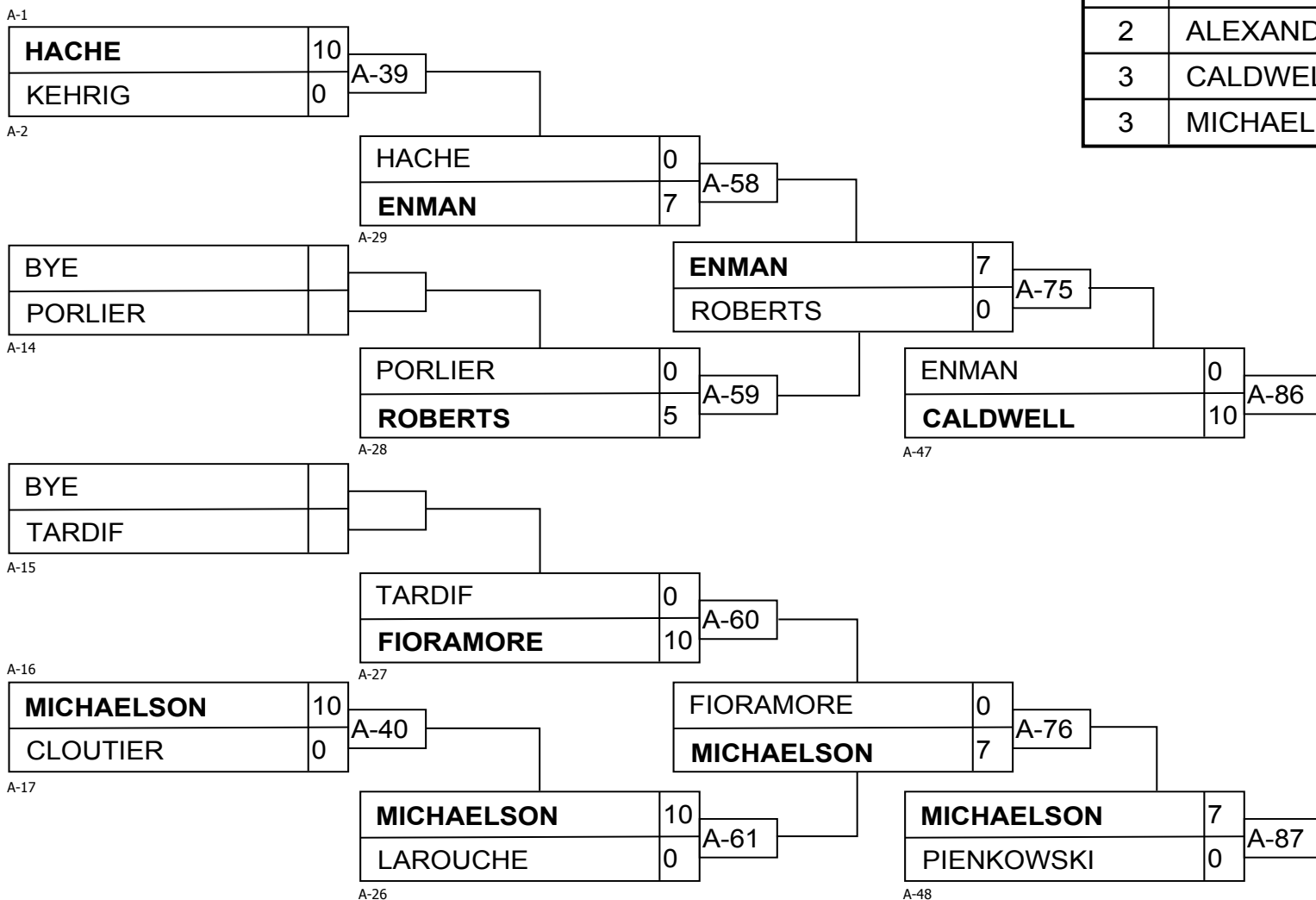



# U16F -57

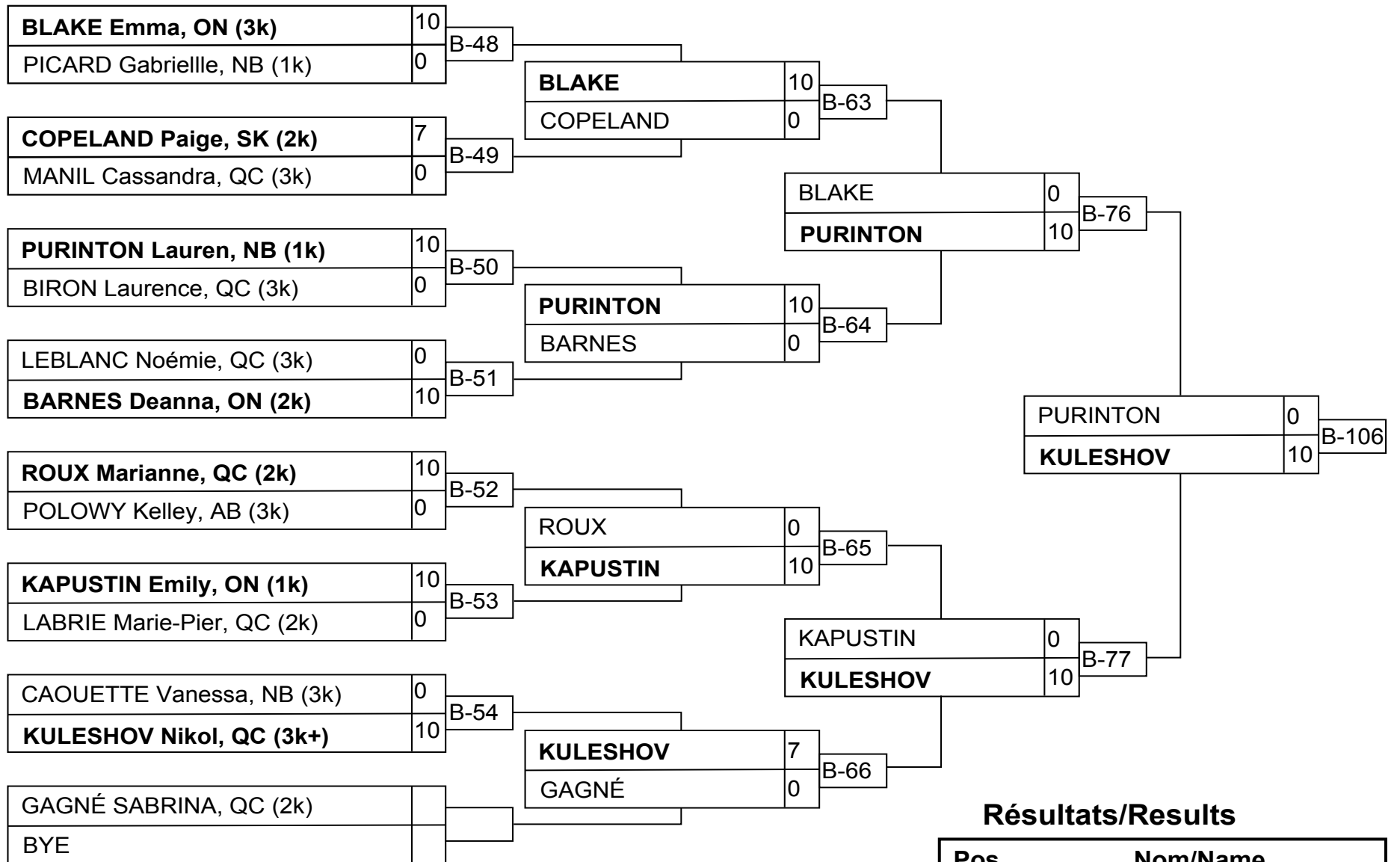

## Résultats/Results

Pos	Nom/Name
1	KULESHOV Nikol, QC (3k+)
2	PURINTON Lauren, NB (1k)
3	BLAKE Emma, ON (3k)
3	BARNES Deanna, ON (2k)

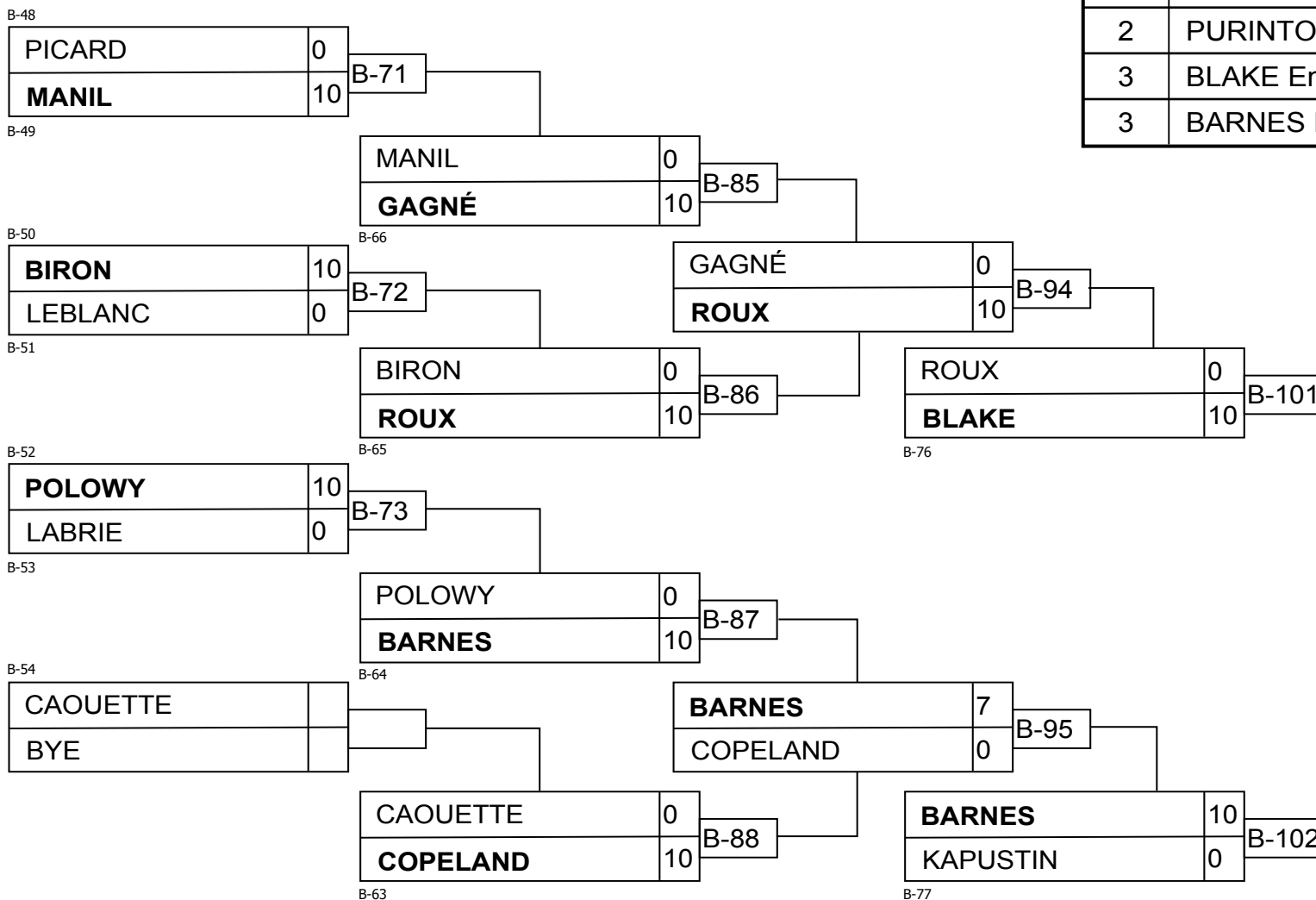

# Omnium 2016 4-5 novembre 2016 Montréal U16F -63

Compétiteurs/Competitors: 4

## Compétiteurs/Competitors

#	Nom/Name	Grade	Club	1	2	3	4	G/W	Pts	Pos
1	RIOUX Karianne	3k	QC			10	10	2	20	2
2	GÉLINAS Sara	2k	QC	10			10	2	20	1
3	FRANCIS Amber-Jane	3k	ON		10			1	10	4
4	FONTAINE Shandra	2k	QC			10		1	10	3

## Matches/Matches

Match	Blanc/White			Bleu/Blue	Rés/Res	Tmp/Tim	Code
C-67	RIOUX Karianne	1	2	GÉLINAS Sara	0 - 10	1:59	IPO
C-68	FRANCIS Amber-Jane	3	4	FONTAINE Shandra	0 - 10	3:00	WIP
C-79	<b>RIOUX Karianne</b>	1	3	FRANCIS Amber-Jane	10 - 0	0:21	IPO
C-80	<b>GÉLINAS Sara</b>	2	4	FONTAINE Shandra	10 - 0	0:46	IPO
C-87	<b>RIOUX Karianne</b>	1	4	FONTAINE Shandra	10 - 0	0:06	IPO
C-88	GÉLINAS Sara	2	3	<b>FRANCIS Amber-Jane</b>	0 - 10	1:34	IPO

## Résultats/Results

Pos	Nom/Name
1	GÉLINAS Sara, QC
2	RIOUX Karianne, QC
3	FONTAINE Shandra, QC
4	FRANCIS Amber-Jane, ON

# Omnium 2016 4-5 novembre 2016 Montréal U16F -70

Compétiteurs/Competitors: 7

## Compétiteurs/Competitors A

#	Nom/Name	Grade	Club	1	2	3	4	G/W	Pts	Pos
1	BAILEY Doerfler	3k+	ON					0	0	4
2	CLOUTIER ALYSON	3k	QC	10				1	10	3
3	GILLIS Ellen	3k	PE	10	10		1	3	21	1
4	GRACIANI Ambar	2k	USA	7	10			2	17	2

## Matches/Matches A

Match	Blanc/White	Bleu/Blue	Rés/Res	Tmp/Tim	Code
A-49	BAILEY Doerfler 1 2	CLOUTIER ALYSON	0 - 10	2:10	IPO
A-50	GILLIS Ellen 3 4	GRACIANI Ambar	1 - 0	3:00	YUS
A-62	BAILEY Doerfler 1 3	GILLIS Ellen	0 - 10	1:36	IPO
A-63	CLOUTIER ALYSON 2 4	GRACIANI Ambar	0 - 10	1:19	IPO
A-77	BAILEY Doerfler 1 4	GRACIANI Ambar	0 - 7	3:00	WAZ
A-78	CLOUTIER ALYSON 2 3	GILLIS Ellen	0 - 10	2:50	IPO

## Compétiteurs/Competitors B

#	Nom/Name	Grade	Club	5	6	7	G/W	Pts	Pos
5	MCCULLOUGH Abbigail	3k	NS		10		1	10	2
6	TURPIN Ariane	3k	QC				0	0	3
7	MOZHAEV Ekaterina	3k	ON	10	10		2	20	1

## Matches/Matches B

Match	Blanc/White	Bleu/Blue	Rés/Res	Tmp/Tim	Code
A-51	MCCULLOUGH Abbigail 5 6	TURPIN Ariane	10 - 0	0:41	IPO
A-64	MCCULLOUGH Abbigail 5 7	MOZHAEV Ekaterina	0 - 10	1:16	IPO
A-79	TURPIN Ariane 6 7	MOZHAEV Ekaterina	0 - 10	0:00	IPO

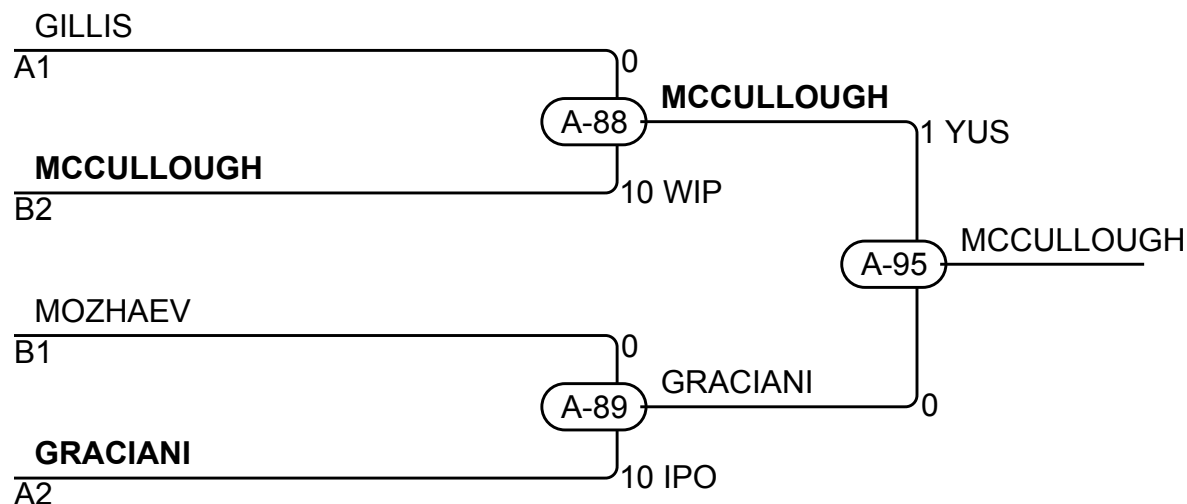

## Résultats/Results

Pos	Nom/Name
1	MCCULLOUGH Abbigail, NS
2	GRACIANI Ambar, USA
3	GILLIS Ellen, PE
3	MOZHAEV Ekaterina, ON

# U16M +73

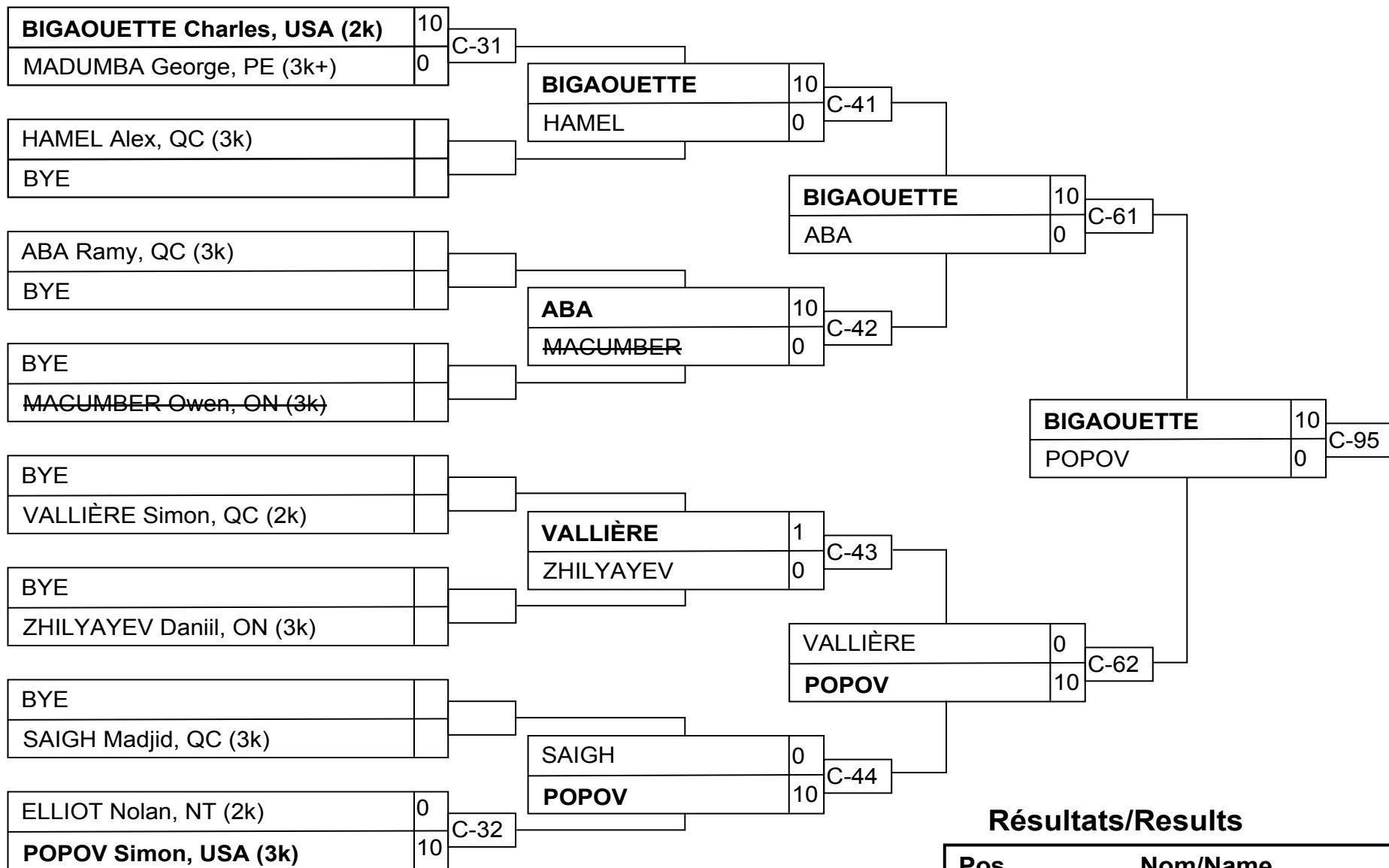

## Résultats/Results

Pos	Nom/Name
1	BIGAOUETTE Charles, USA (2k)
2	POPOV Simon, USA (3k)
3	ABA Ramy, QC (3k)
3	VALLIÈRE Simon, QC (2k)

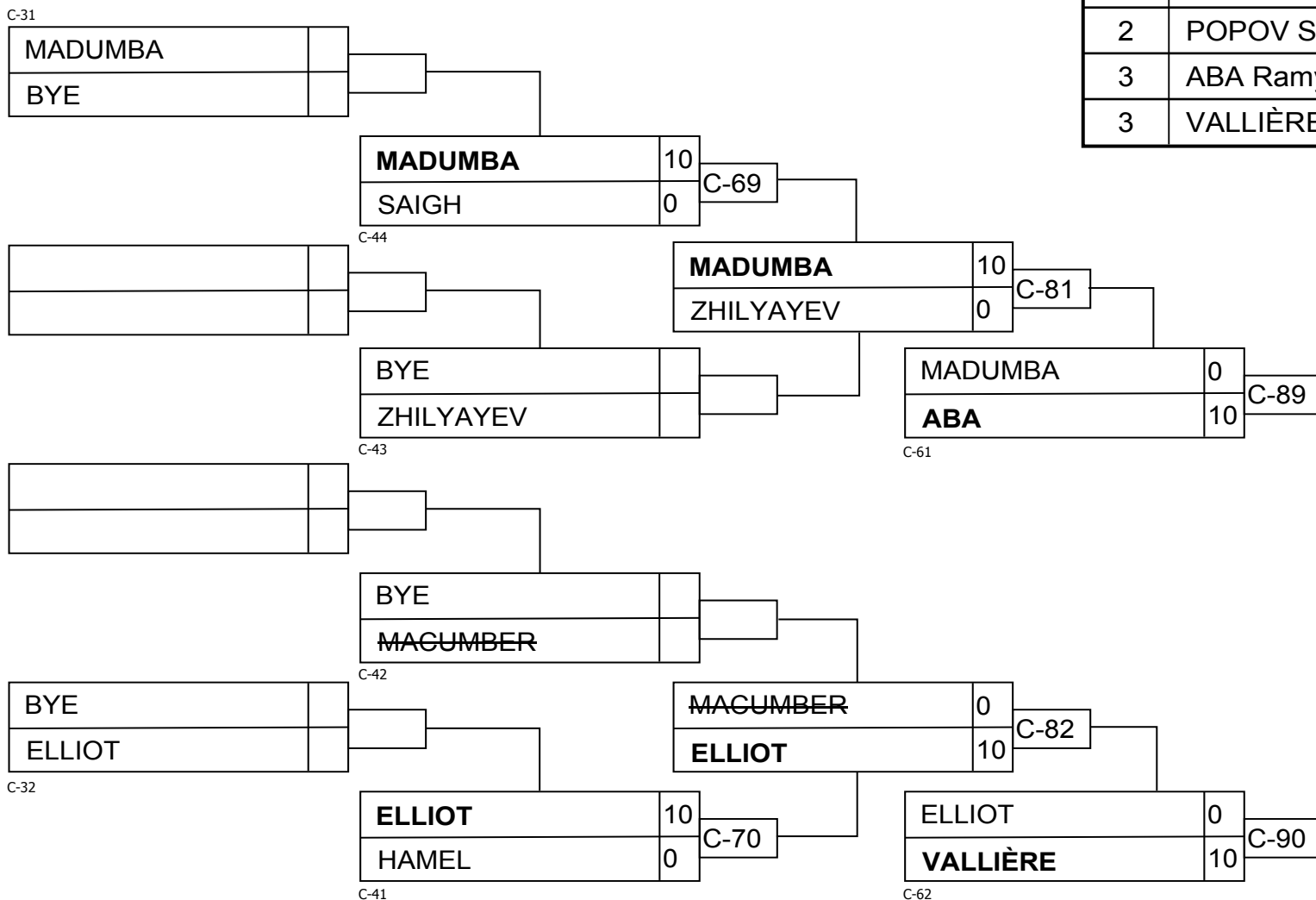

# U16M -38

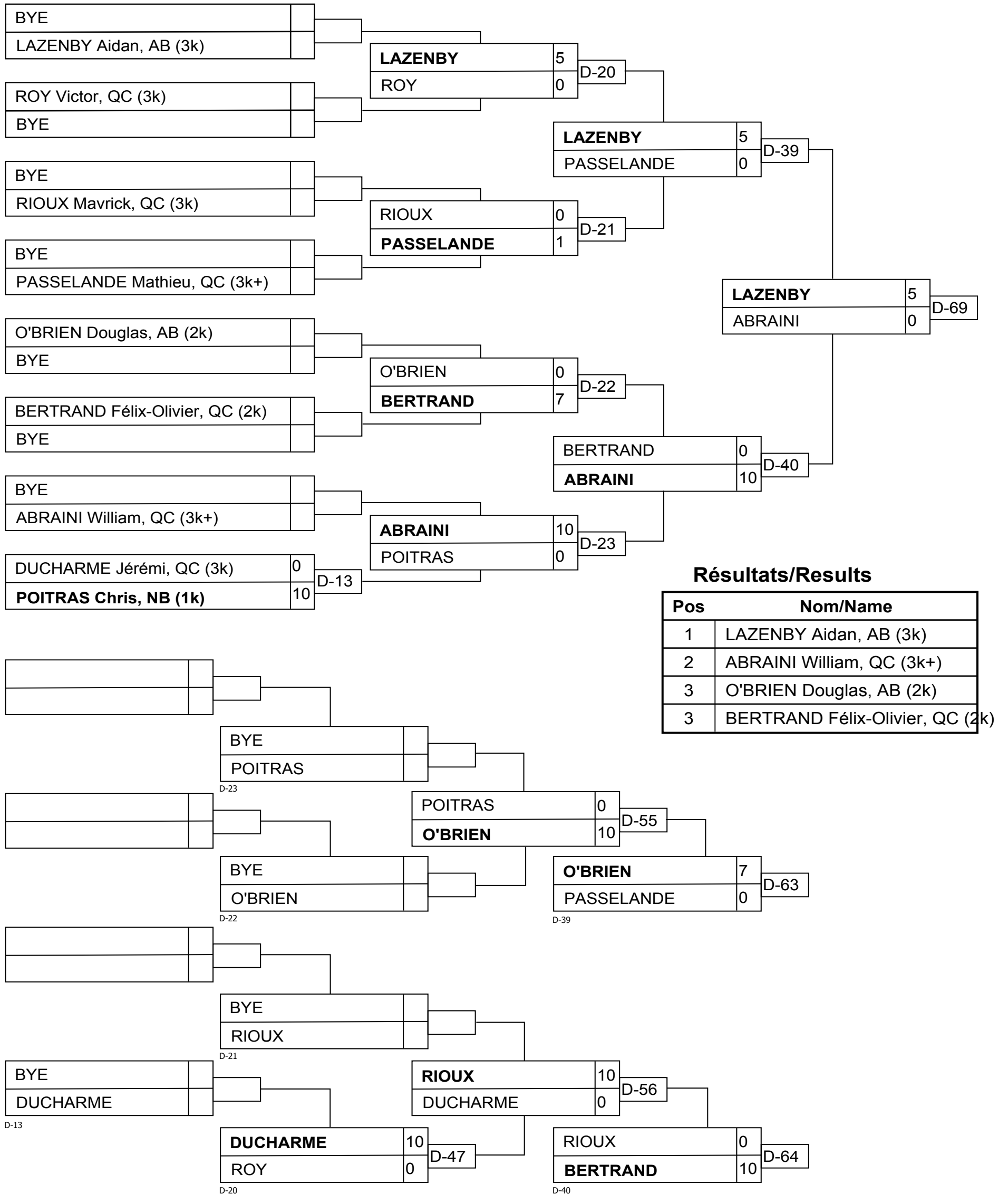

## Résultats/Results

Pos	Nom/Name
1	LAZENBY Aidan, AB (3k)
2	ABRAINI William, QC (3k+)
3	O'BRIEN Douglas, AB (2k)
3	BERTRAND Félix-Olivier, QC (2k)

# U16M -42

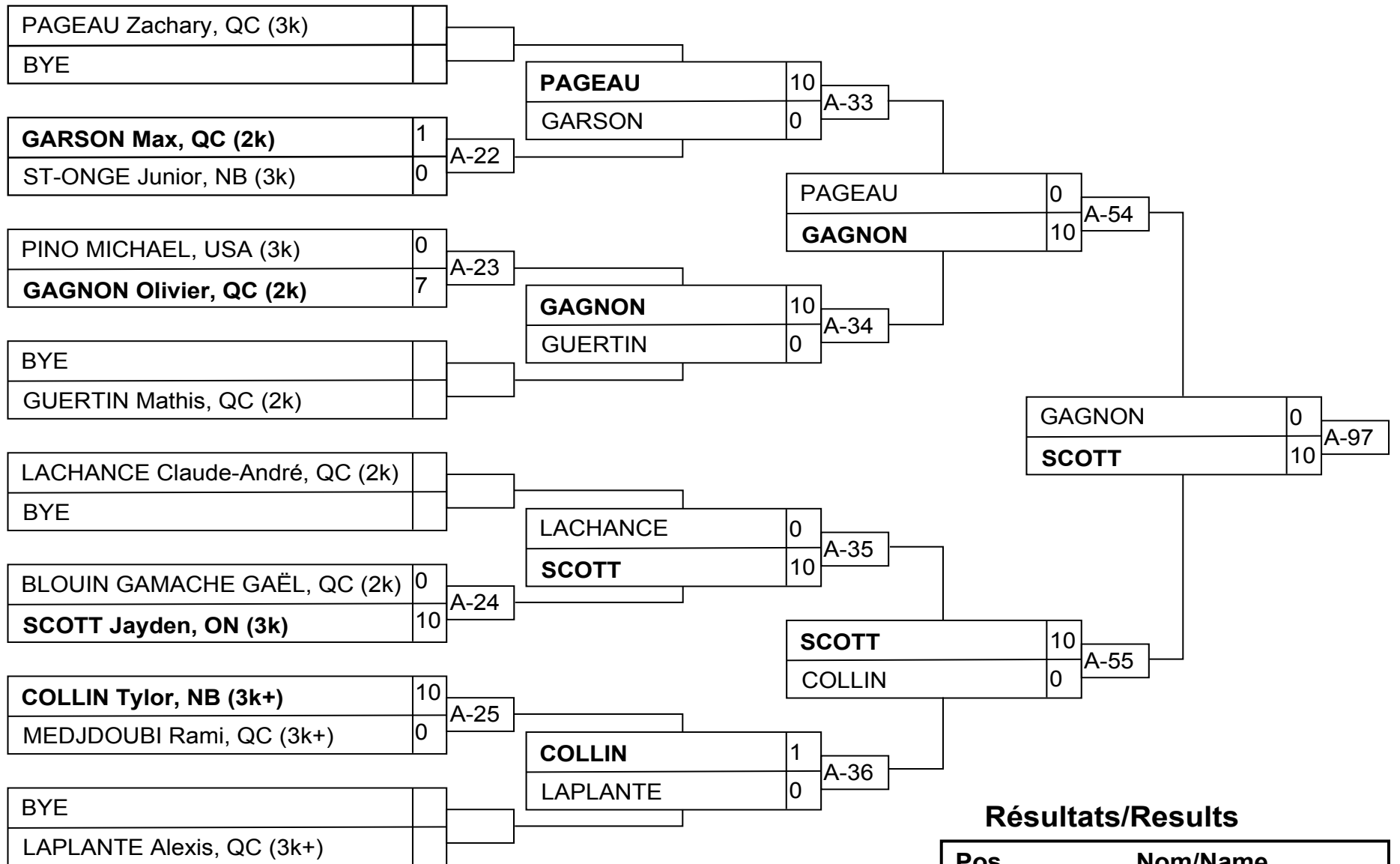

## Résultats/Results

Pos	Nom/Name
1	SCOTT Jayden, ON (3k)
2	GAGNON Olivier, QC (2k)
3	PINO MICHAEL, USA (3k)
3	GARSON Max, QC (2k)

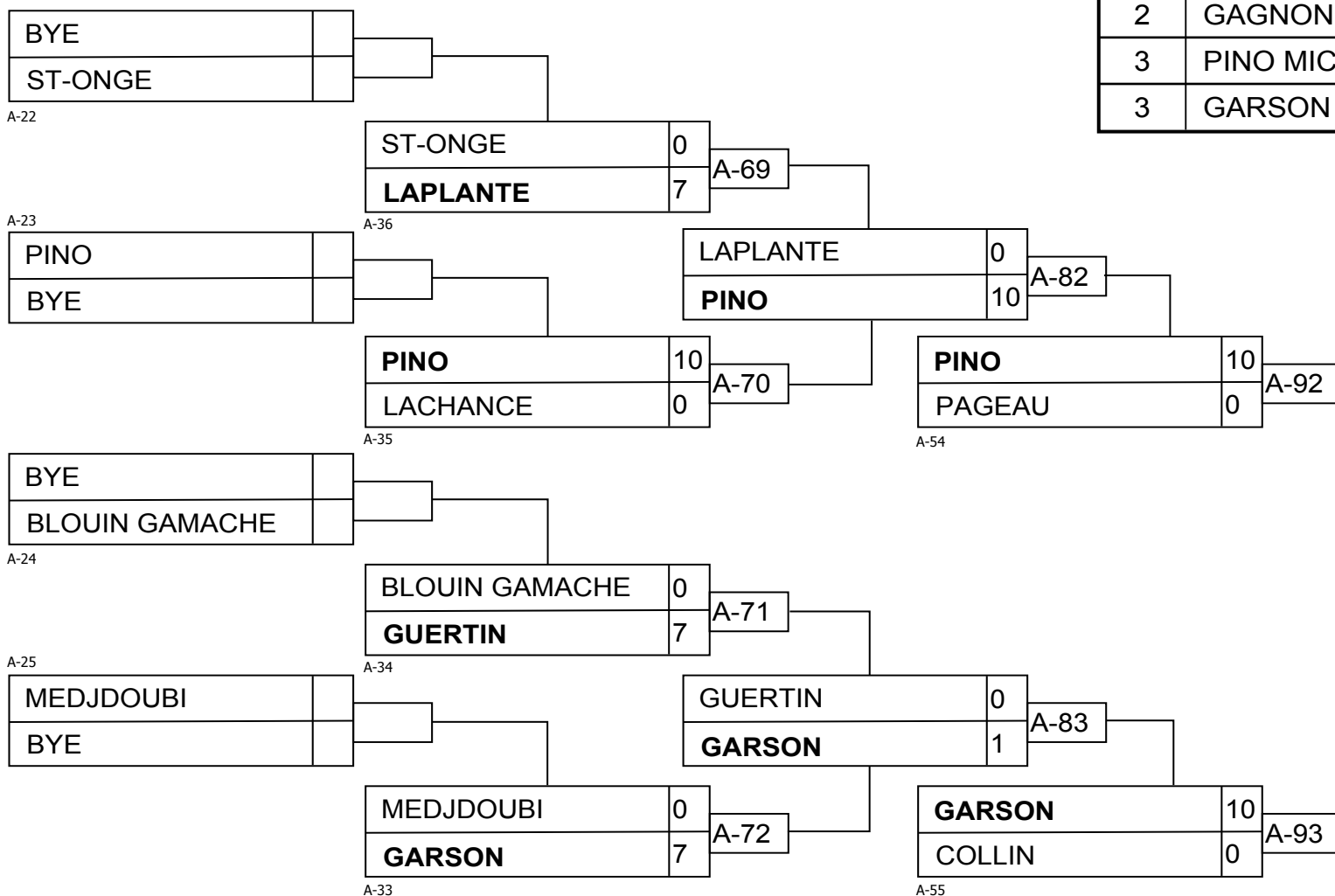

# U16M -46

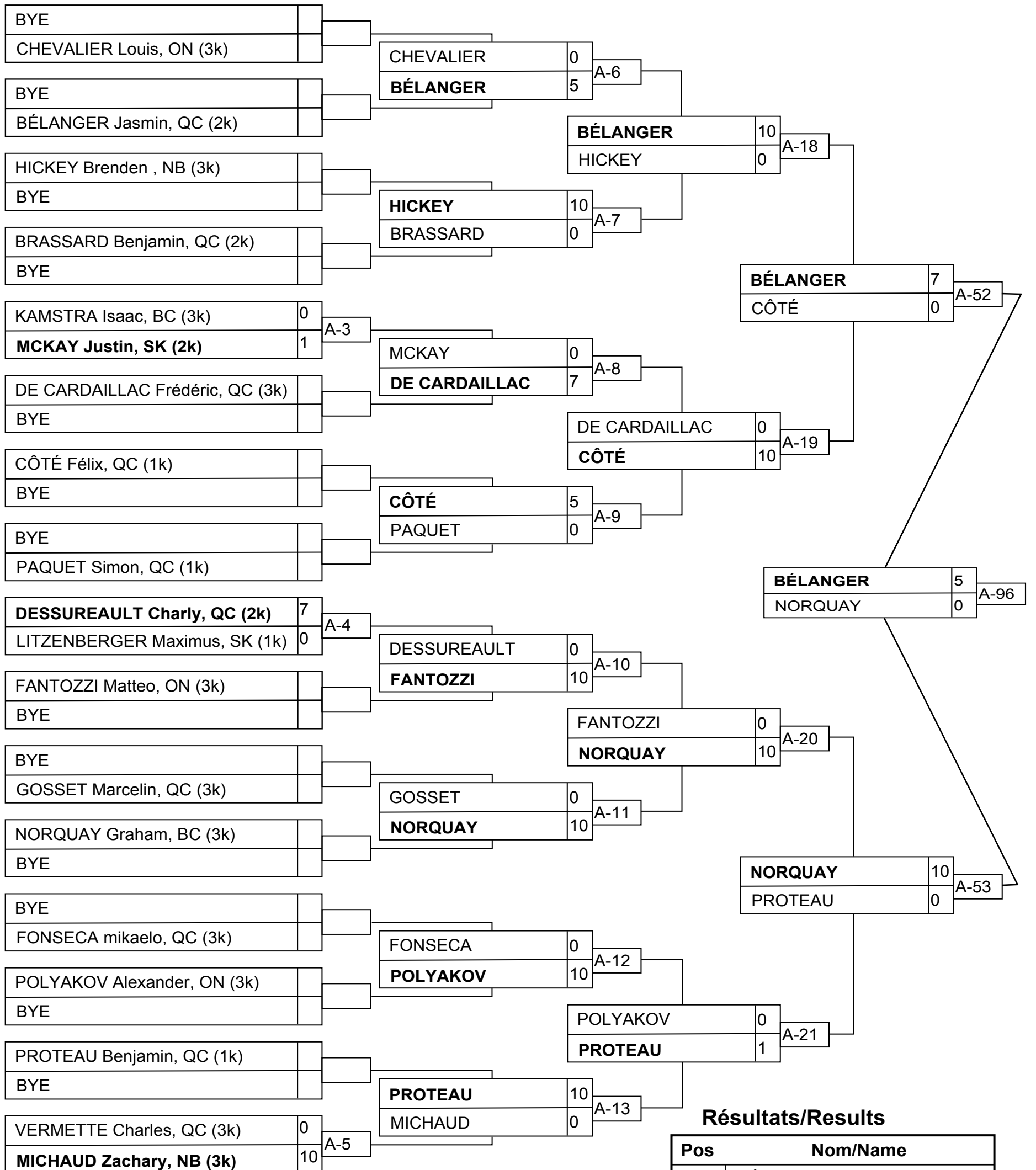

## Résultats/Results

Pos	Nom/Name
1	BÉLANGER Jasmin, QC (2k)
2	NORQUAY Graham, BC (3k)
3	PAQUET Simon, QC (1k)
3	LITZENBERGER Maximus, SK (1k)

# U16M -46

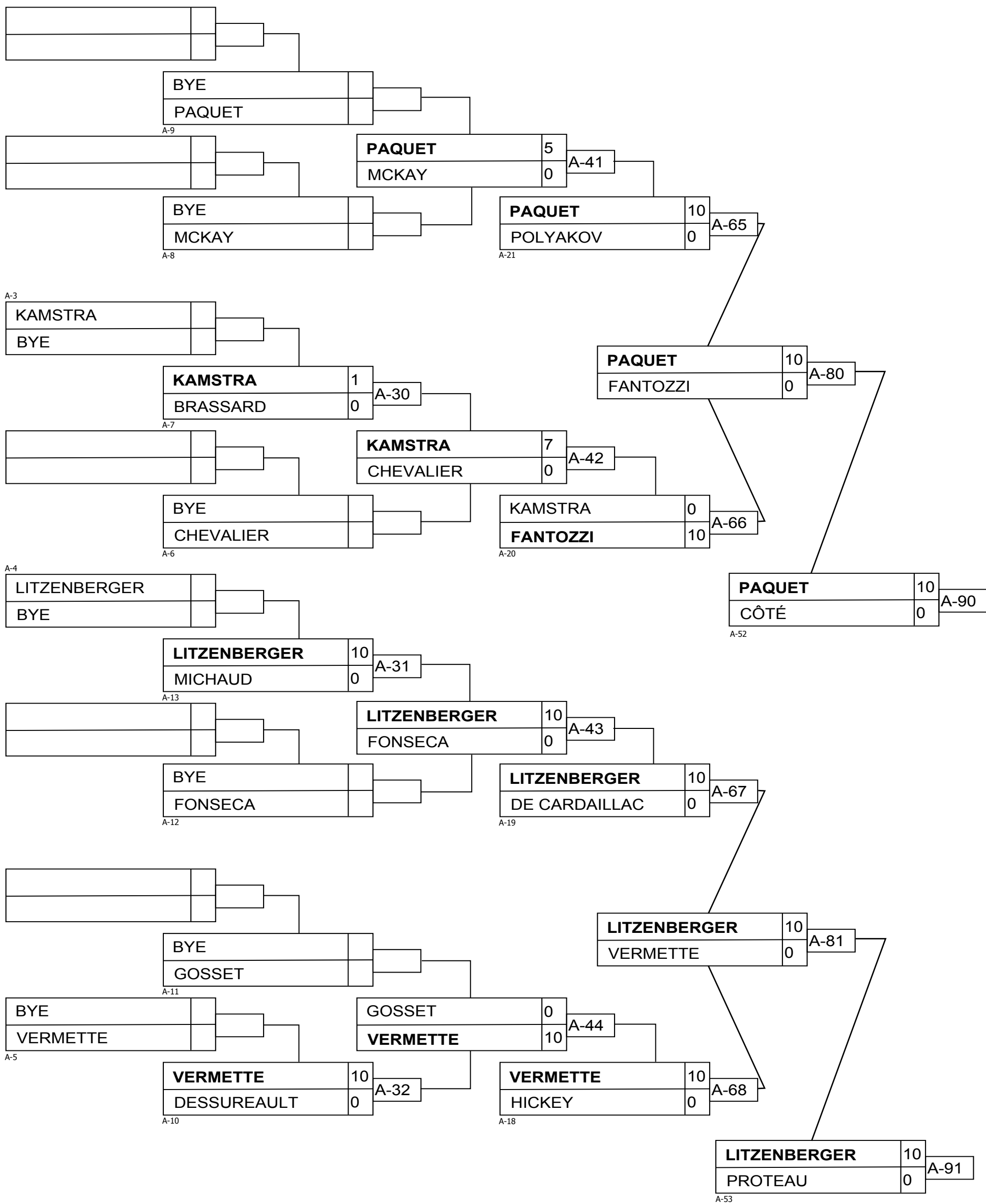



# U16M -50

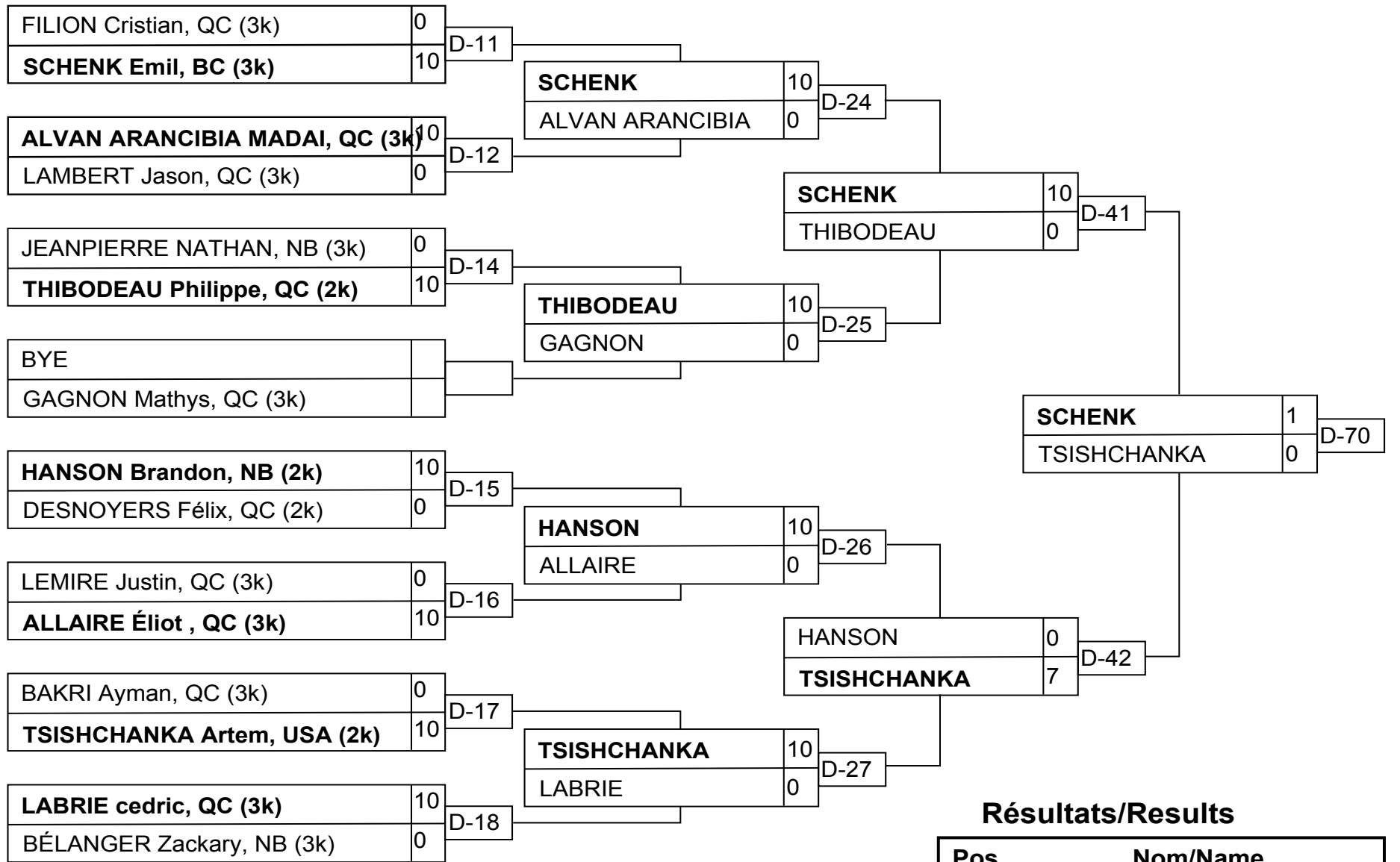

## Résultats/Results

Pos	Nom/Name
1	SCHENK Emil, BC (3k)
2	TSISHCHANKA Artem, USA (2k)
3	THIBODEAU Philippe, QC (2k)
3	HANSON Brandon, NB (2k)

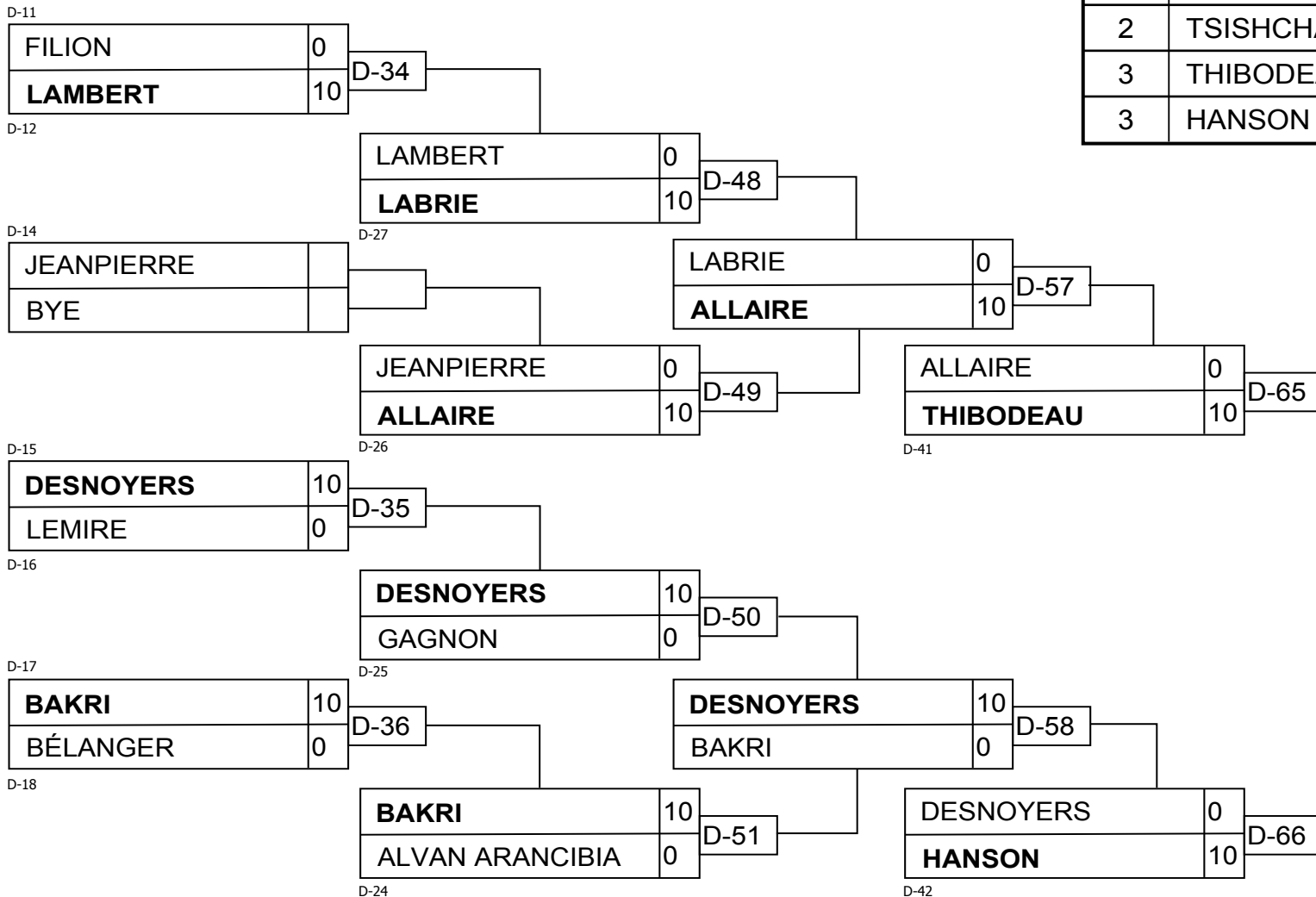

# U16M -55

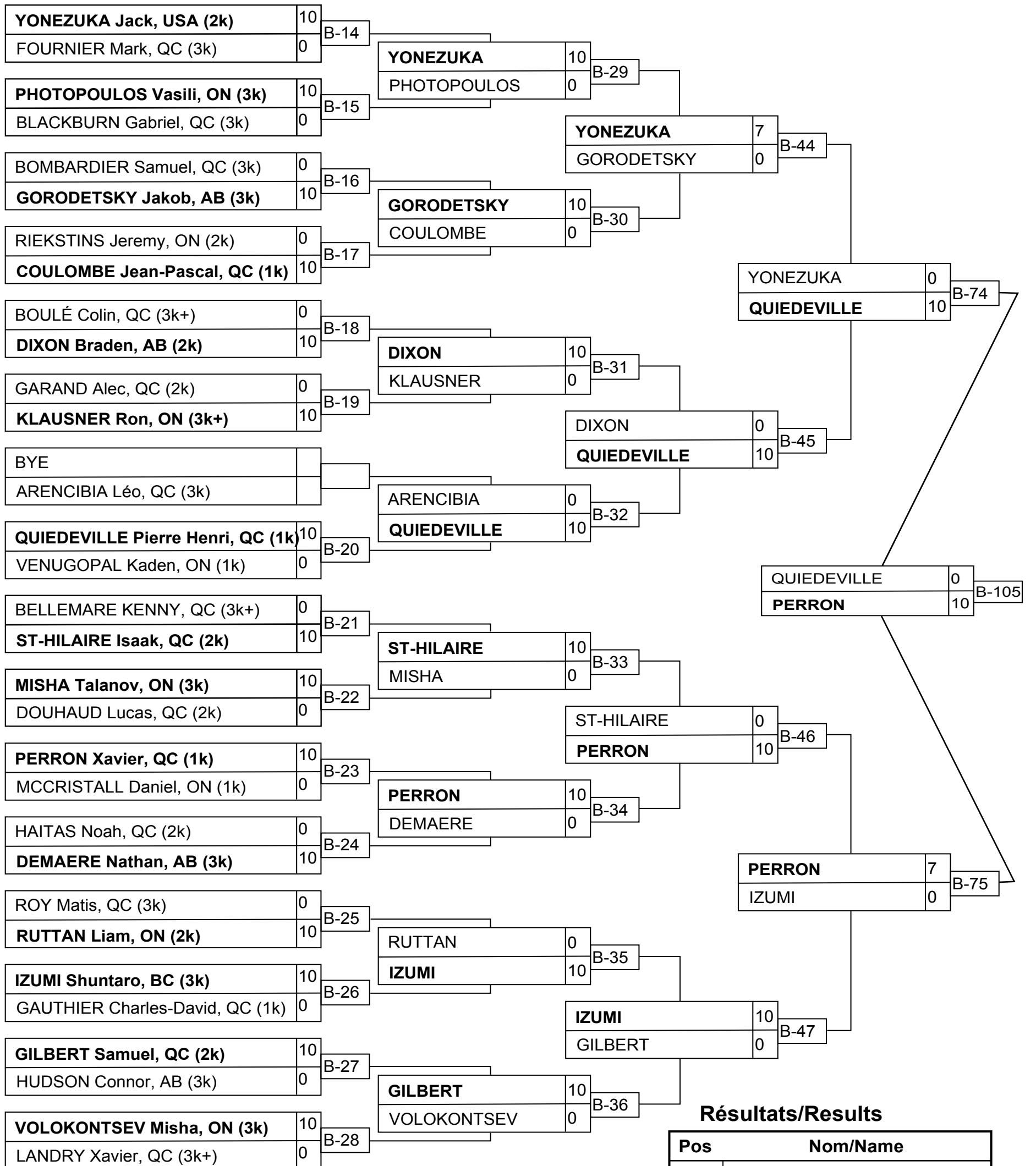

## Résultats/Results

Pos	Nom/Name
1	PERRON Xavier, QC (1k)
2	QUIEDEVILLE Pierre Henri, QC (1k)
3	YONEZUKA Jack, USA (2k)
3	IZUMI Shuntaro, BC (3k)

# U16M -55

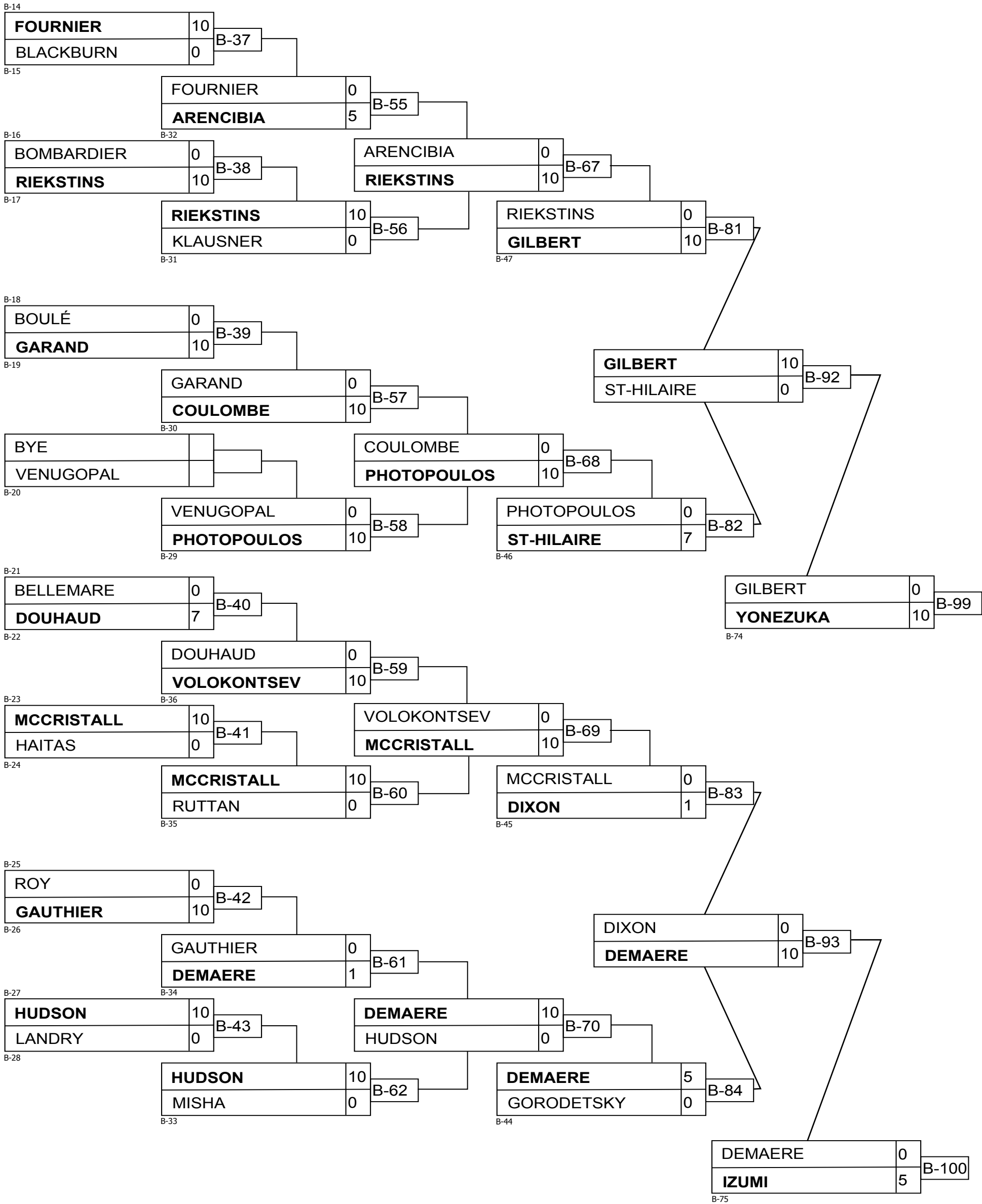

# U16M -60

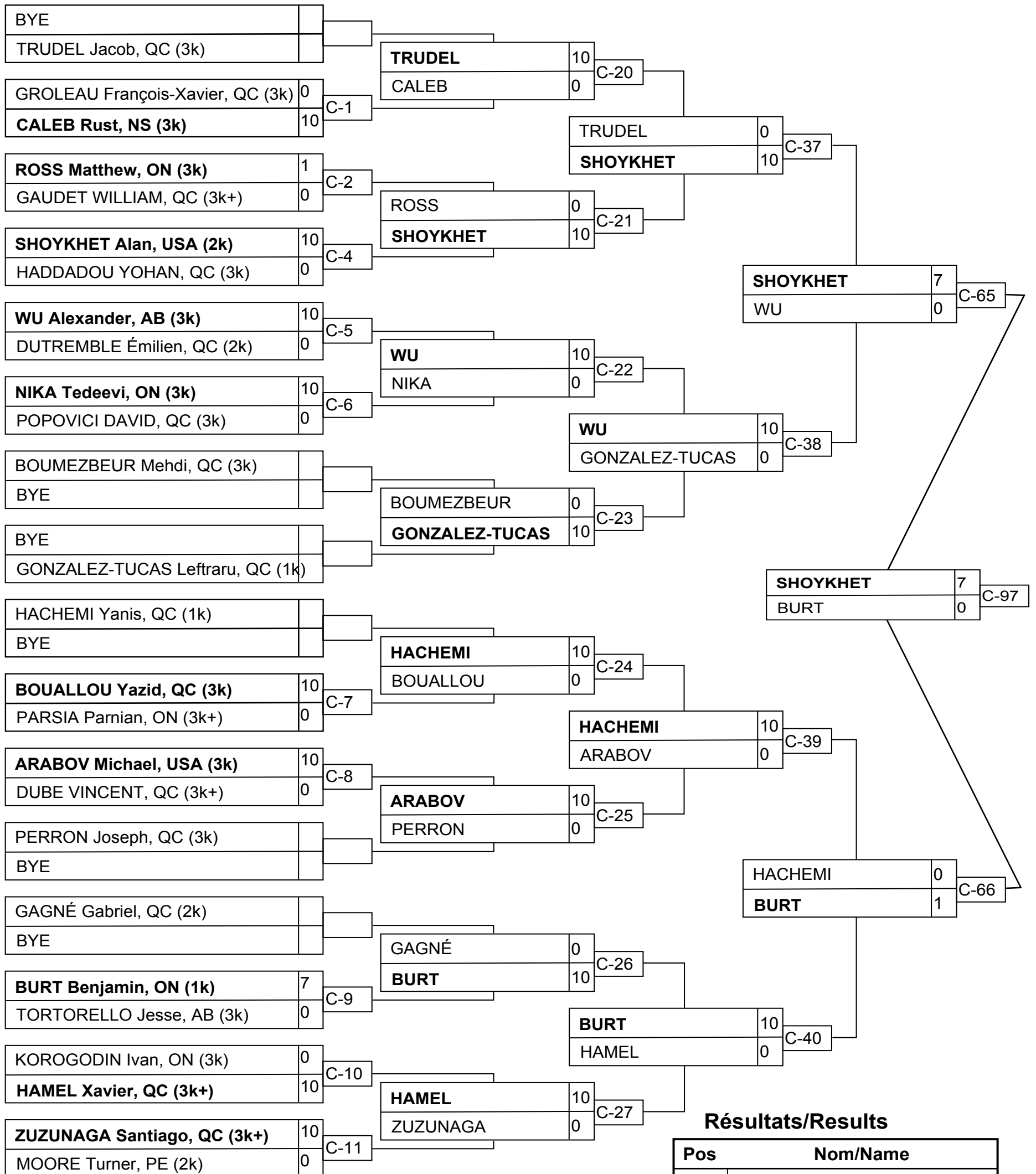

## Résultats/Results

Pos	Nom/Name
1	SHOYKHET Alan, USA (2k)
2	BURT Benjamin, ON (1k)
3	ARABOV Michael, USA (3k)
3	HACHEMI Yanis, QC (1k)

# U16M -60

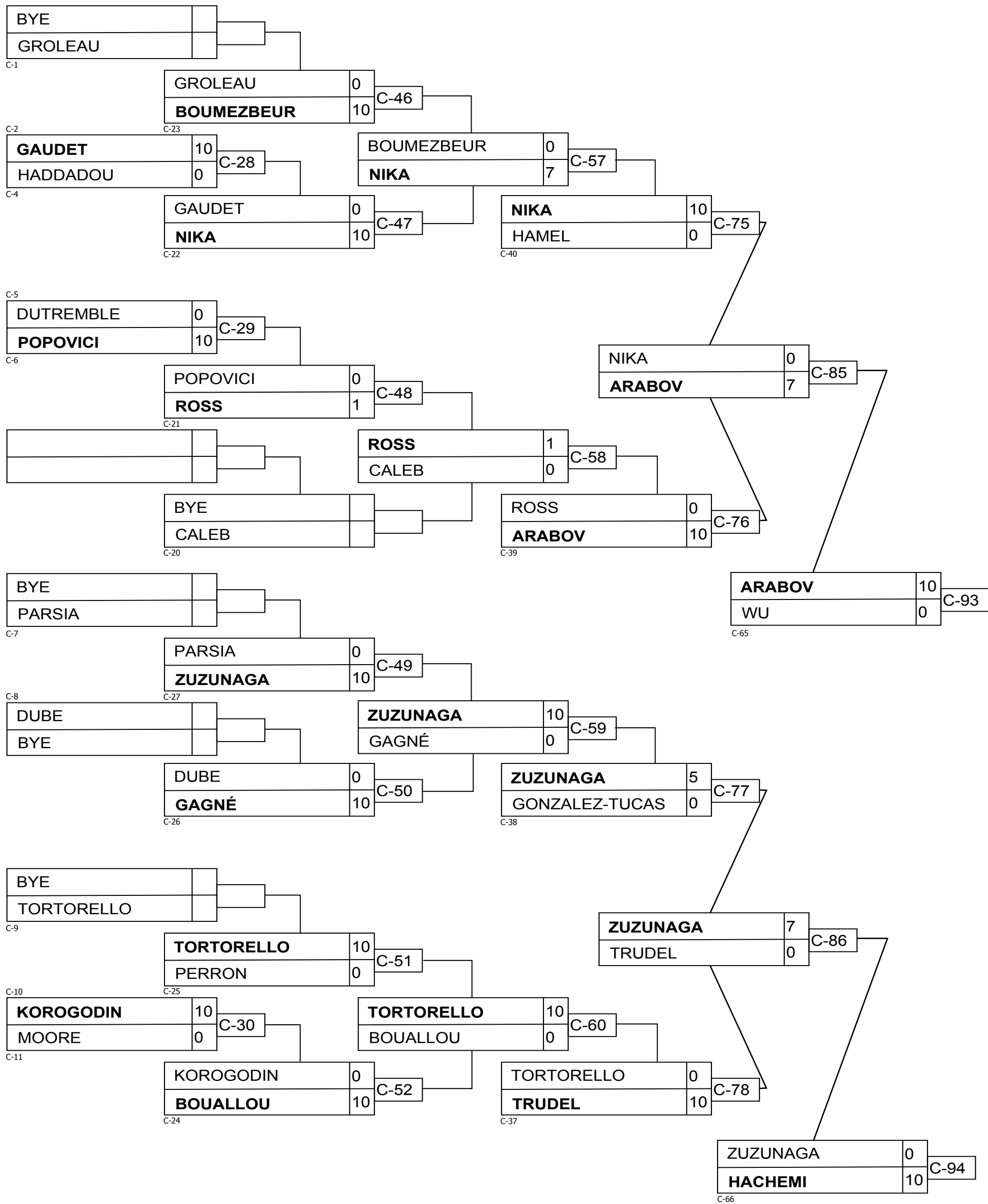

# U16M -66

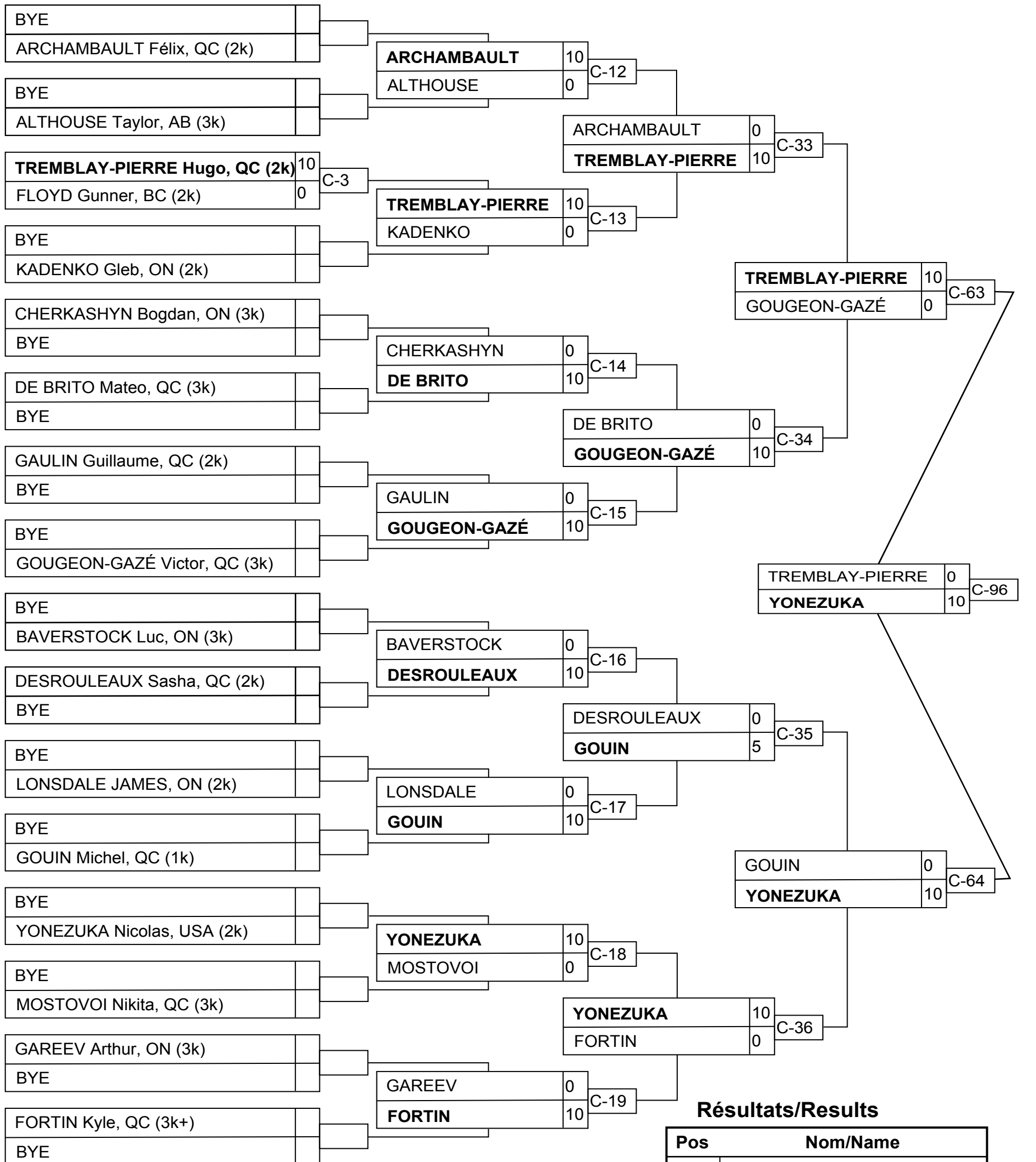

## Résultats/Results

Pos	Nom/Name
1	YONEZUKA Nicolas, USA (2k)
2	TREMBLAY-PIERRE Hugo, QC (2k)
3	FLOYD Gunner, BC (2k)
3	LONSDALE JAMES, ON (2k)

# U16M -66

