

SenF -52

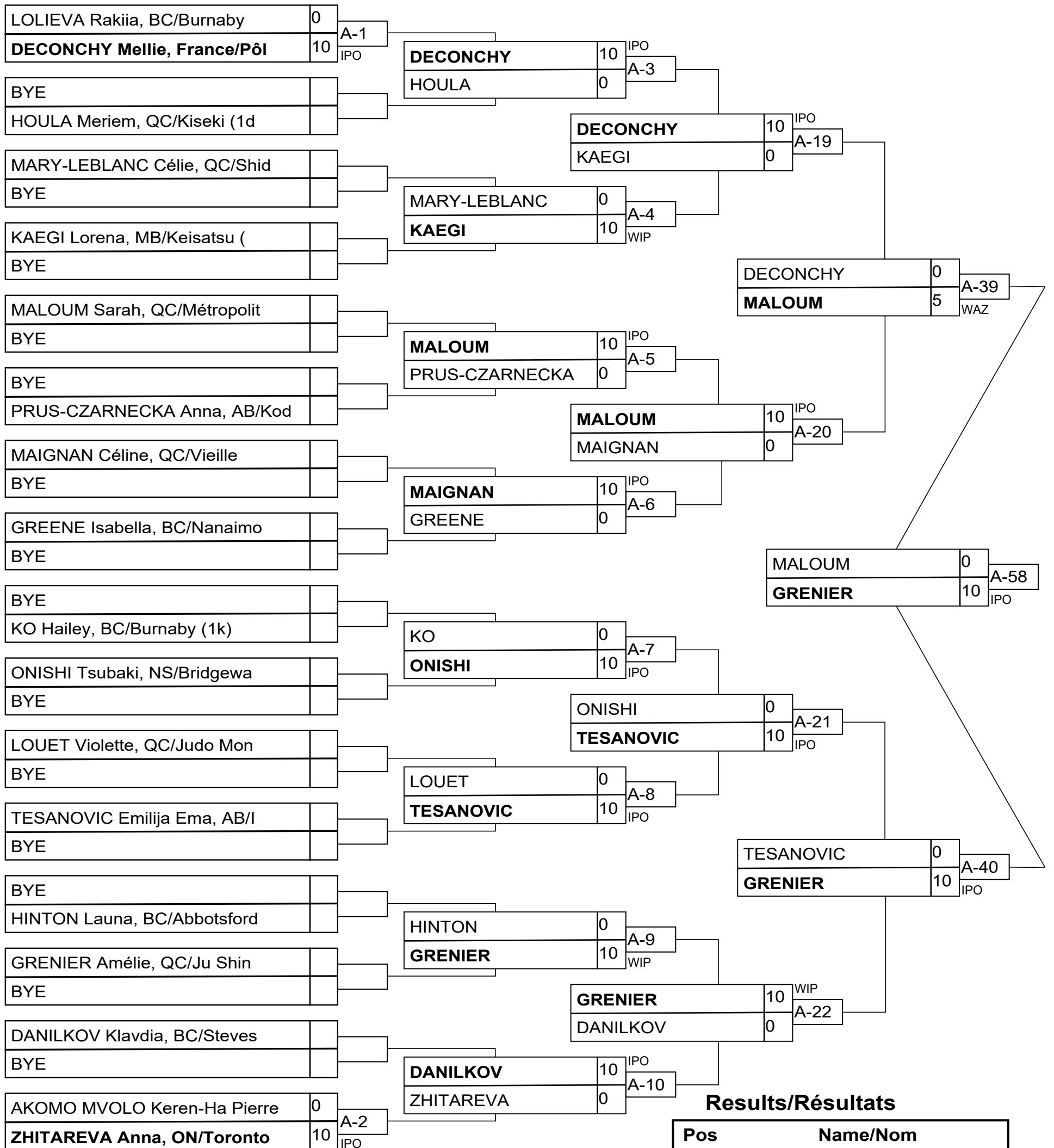

Results/Résultats

Pos	Name/Nom
1	GRENIER Amélie, QC/Ju Sh
2	MALOUM Sarah, QC/Métropo
3	DECONCHY Mellie, France/
3	TESANOVIC Emilija Ema, A

SenF -52

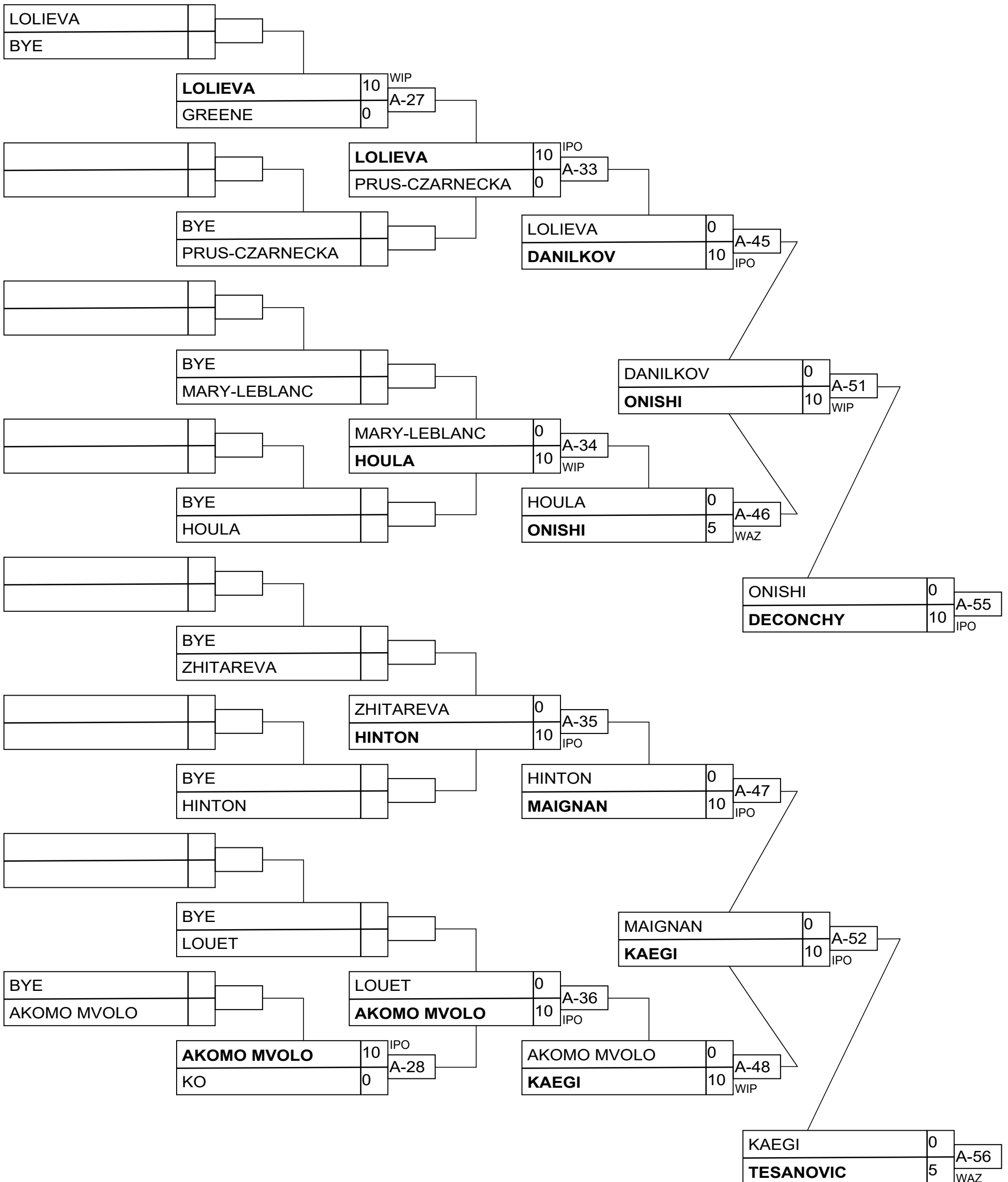

SenF -57

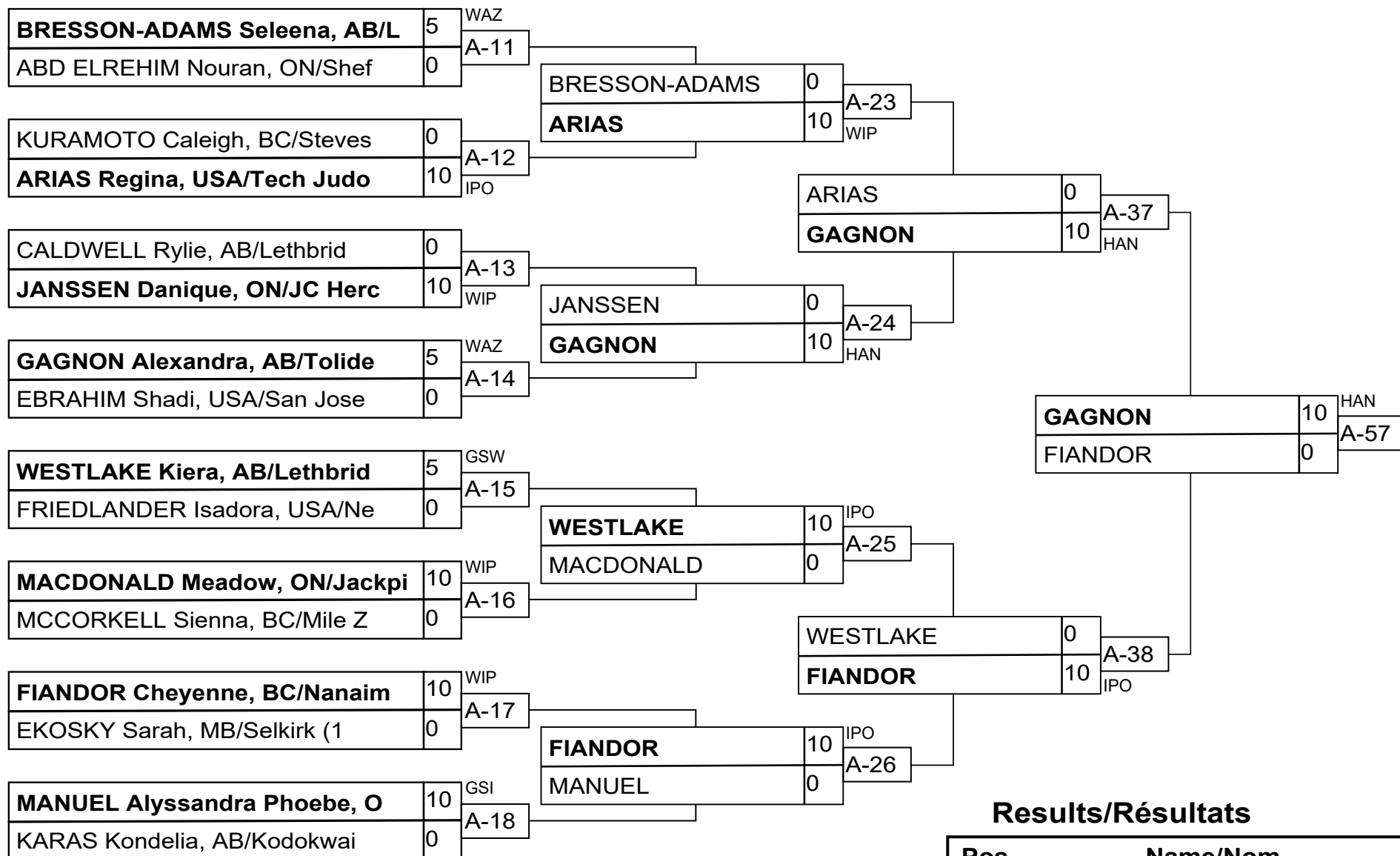

Results/Résultats

Pos	Name/Nom
1	GAGNON Alexandra, AB/Tol
2	FIANDOR Cheyenne, BC/Nan
3	EBRAHIM Shadi, USA/San J
3	FRIEDLANDER Isadora, USA

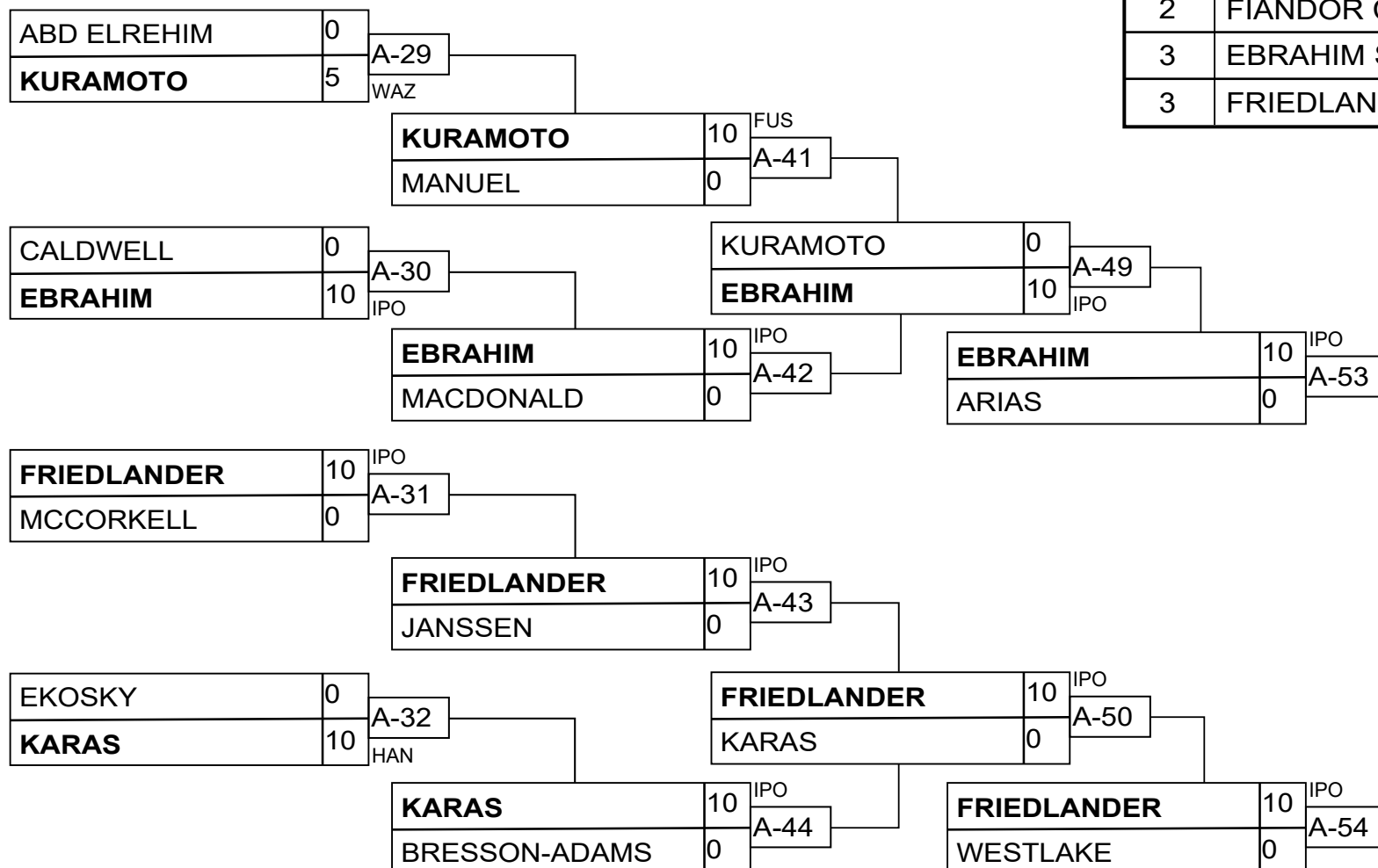

SenF -63

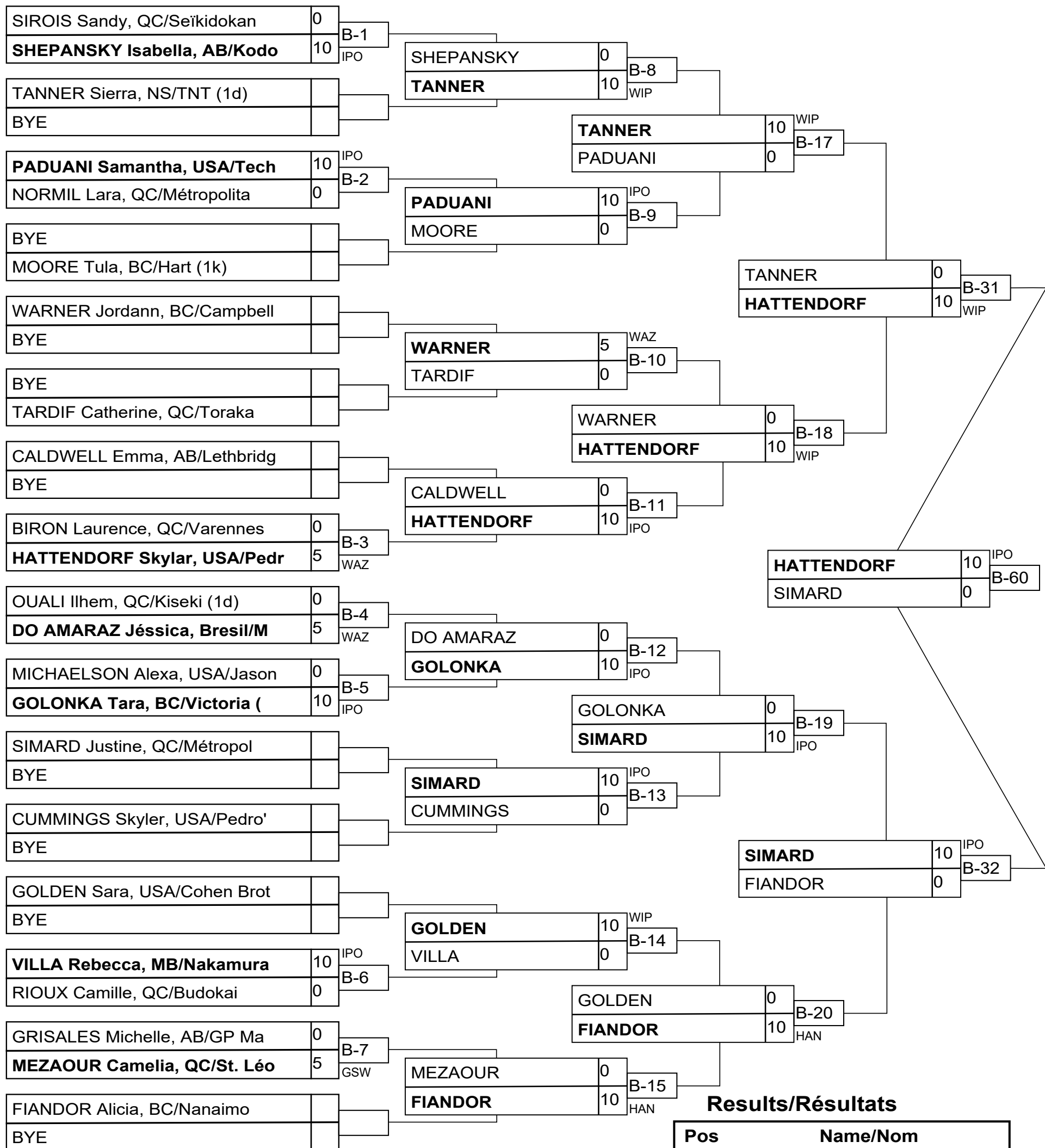

Results/Résultats

Pos	Name/Nom
1	HATTENDORF Skylar, USA/P
2	SIMARD Justine, QC/Méto
3	GOLDEN Sara, USA/Cohen B
3	FIANDOR Alicia, BC/Nanai

SenF -63

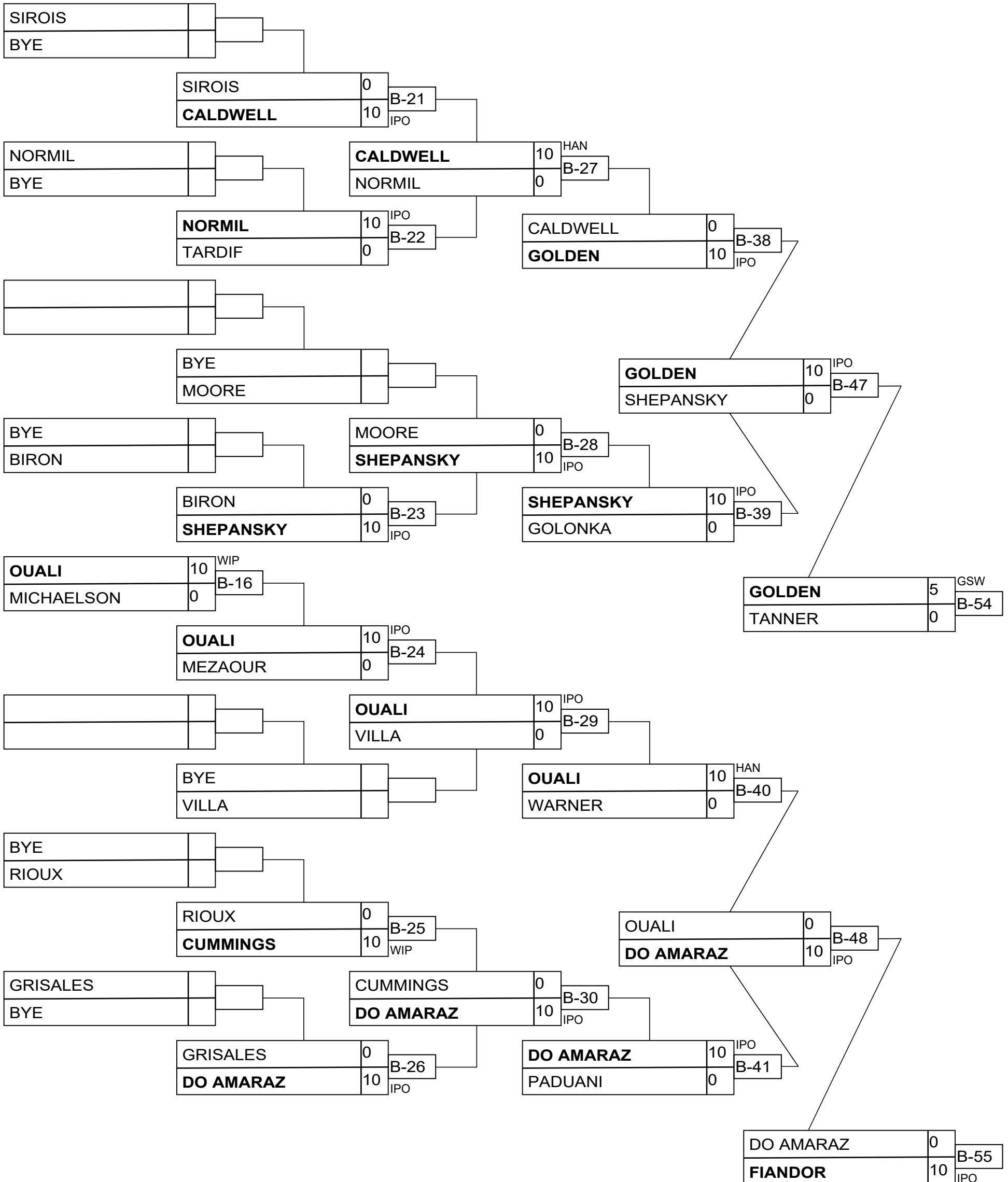

SenF -78

Competitors/Compétiteurs A

#	Name/Nom	Grade	Club	1	2	3	W/G	Pts	Pos
1	SOMMERFELD Bishop (0,00)	1d	SK/Regina Y	XX			0	0	3
2	GRONEN Shianne (0,00)	1d	AB/Lethbridge	10	XX	10	2	20	1
3	SYNOTT Josie-Anne (0,00)	1d	QC/Sept-Iles	10		XX	1	10	2

Matches/Matches A

Match	White/Blanc			Blue/Bleu	Res/Rés	Tim/Tmp	Code
B-36	SOMMERFELD Bishop	1	2	GRONEN Shianne	0 - 10	2:33	IPO
B-45	SOMMERFELD Bishop	1	3	SYNOTT Josie-Anne	0 - 10	2:45	IPO
B-52	GRONEN Shianne	2	3	SYNOTT Josie-Anne	10 - 0	0:13	IPO

Competitors/Compétiteurs B

#	Name/Nom	Grade	Club	4	5	6	W/G	Pts	Pos
4	STOUT Nicole (0,00)	1d	USA/Jason Morris	XX		10	1	10	2
5	GODBOUT Coralie (0,00)	1d	QC/Vieille Capitale	10	XX	10	2	20	1
6	DARLOW Annabelle (0,00)	1d	AB/Lethbridge			XX	0	0	3

Matches/Matches B

Match	White/Blanc			Blue/Bleu	Res/Rés	Tim/Tmp	Code
B-37	STOUT Nicole	4	5	GODBOUT Coralie	0 - 10	1:53	WIP
B-46	STOUT Nicole	4	6	DARLOW Annabelle	10 - 0	0:15	IPO
B-53	GODBOUT Coralie	5	6	DARLOW Annabelle	10 - 0	2:21	IPO

GRONEN

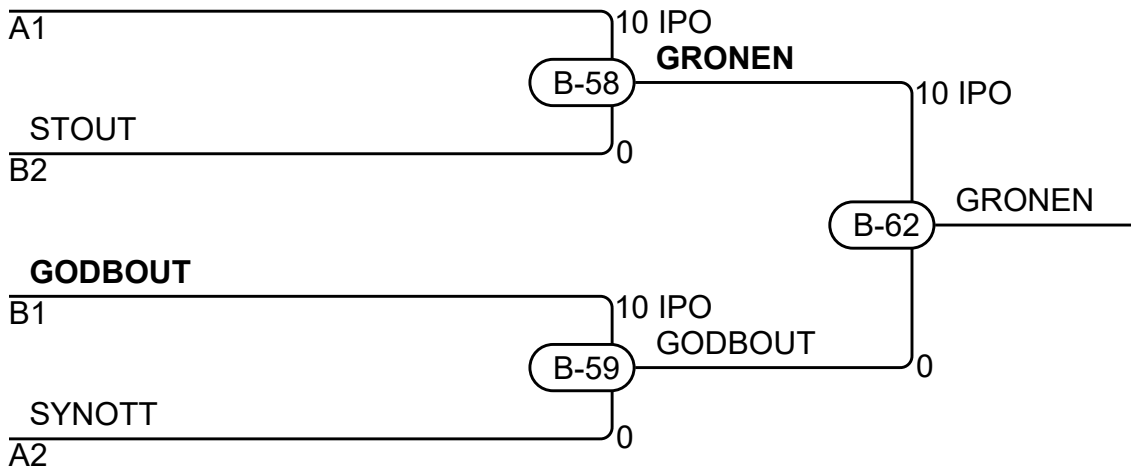

Results/Résultats

Pos	Name/Nom
1	GRONEN Shianne, AB/Lethbridge
2	GODBOUT Coralie, QC/Vieille Capitale
3	STOUT Nicole, USA/Jason Morris
3	SYNOTT Josie-Anne, QC/Sept-Iles

SenM -100

Competitors/Compétiteurs A

#	Name/Nom	Grade	Club	1	2	3	4	W/G	Pts	Pos
1	ROBIN Alexis (0,00)	1d	QC/Olympique	XX	10	10	10	3	30	1
2	CHAMPAGNE Jérôme (0,00)	1k	QC/Varenes		XX		10	1	10	3
3	HURST Matt (0,00)	1d	NB/Dragons Judo Club		10	XX	10	2	20	2
4	DORE Nicholas (0,00)	1d	ON/Takahashi				XX	0	0	4

Matches/Matches A

Match	White/Blanc	Blue/Bleu	Res/Rés	Tim/Tmp	Code
B-33	ROBIN Alexis	1 2 CHAMPAGNE Jérôme	10 - 0	4:41	IPO
B-34	HURST Matt	3 4 DORE Nicholas	10 - 0	1:30	WIP
B-42	ROBIN Alexis	1 3 HURST Matt	10 - 0	0:54	IPO
B-43	CHAMPAGNE Jérôme	2 4 DORE Nicholas	10 - 0	2:50	HAN
B-49	ROBIN Alexis	1 4 DORE Nicholas	10 - 0	0:22	IPO
B-50	CHAMPAGNE Jérôme	2 3 HURST Matt	0 - 10	0:25	IPO

Competitors/Compétiteurs B

#	Name/Nom	Grade	Club	5	6	7	W/G	Pts	Pos
5	BOARO Kristopher (0,00)	1d	ON/North Bay	XX			0	0	3
6	MARCONNET Yohann (0,00)	1d	QC/Jikan	10	XX	10	2	20	1
7	ST LOUIS Terry (0,00)	1k	ON/Sho Jin	10		XX	1	10	2

Matches/Matches B

Match	White/Blanc	Blue/Bleu	Res/Rés	Tim/Tmp	Code
B-35	BOARO Kristopher	5 6 MARCONNET Yohann	0 - 10	0:00	FUS
B-44	BOARO Kristopher	5 7 ST LOUIS Terry	0 - 10	0:00	FUS
B-51	MARCONNET Yohann	6 7 ST LOUIS Terry	10 - 0	0:54	IPO

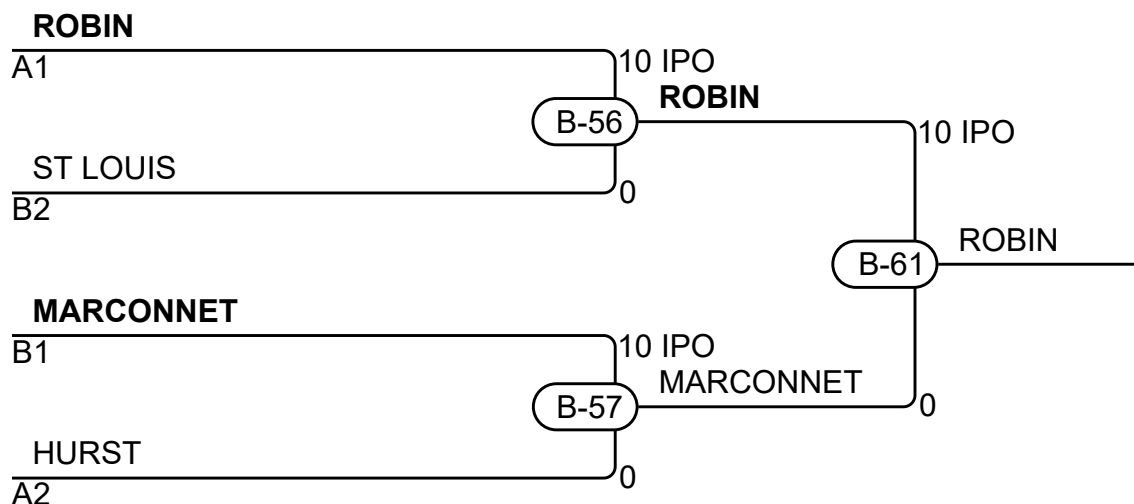

Results/Résultats

Pos	Name/Nom
1	ROBIN Alexis, QC/Olympique
2	MARCONNET Yohann, QC/Jikan
3	ST LOUIS Terry, ON/Sho Jin
3	HURST Matt, NB/Dragons Judo Club

SenM -66

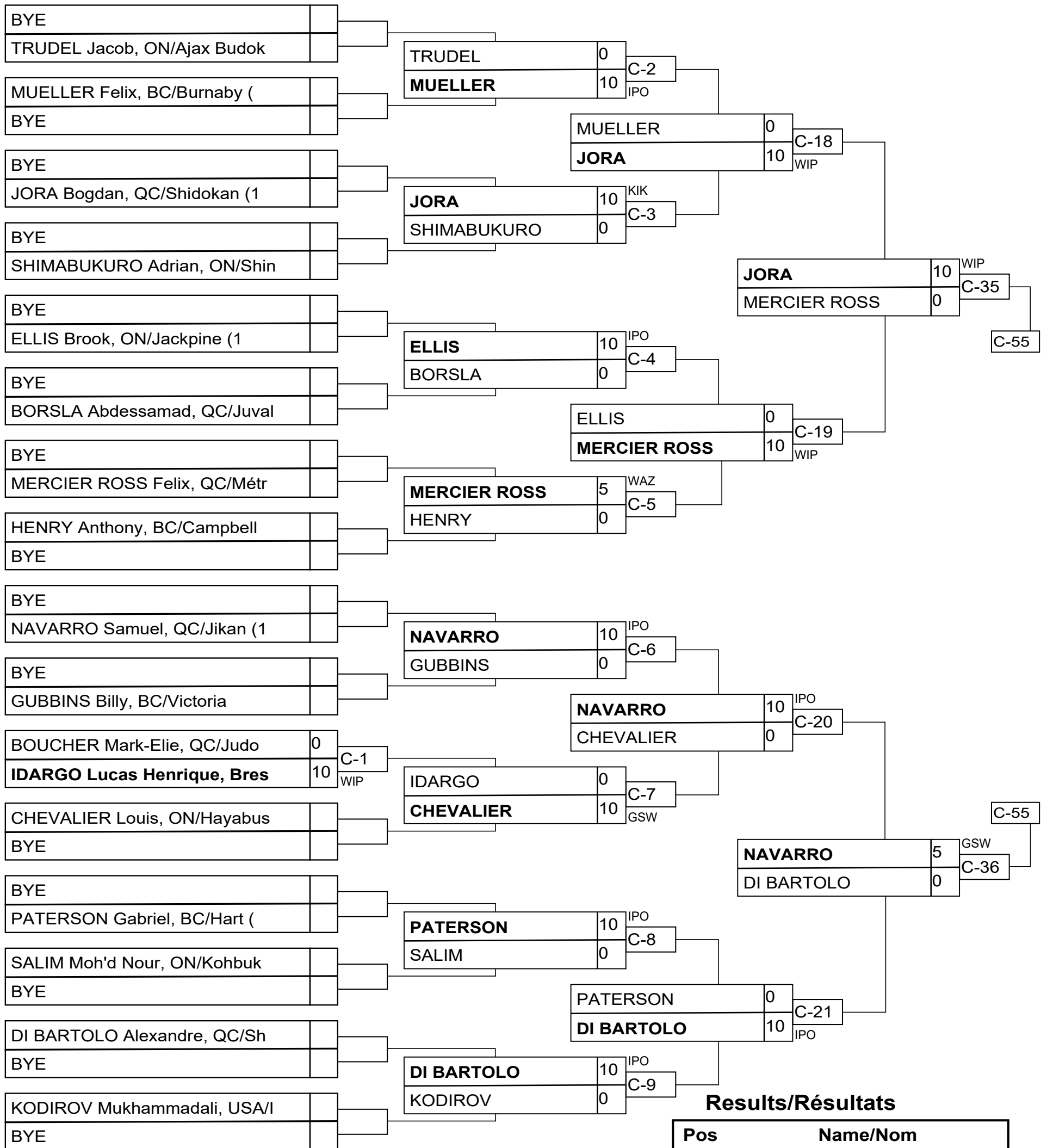

Results/Résultats

Pos	Name/Nom
1	CHALA Hakim, QC/Kiseki (
2	JORA Bogdan, QC/Shidokan
3	SCHROEDER Finn, BC/Victo
3	NAVARRO Samuel, QC/Jikan

SenM -66

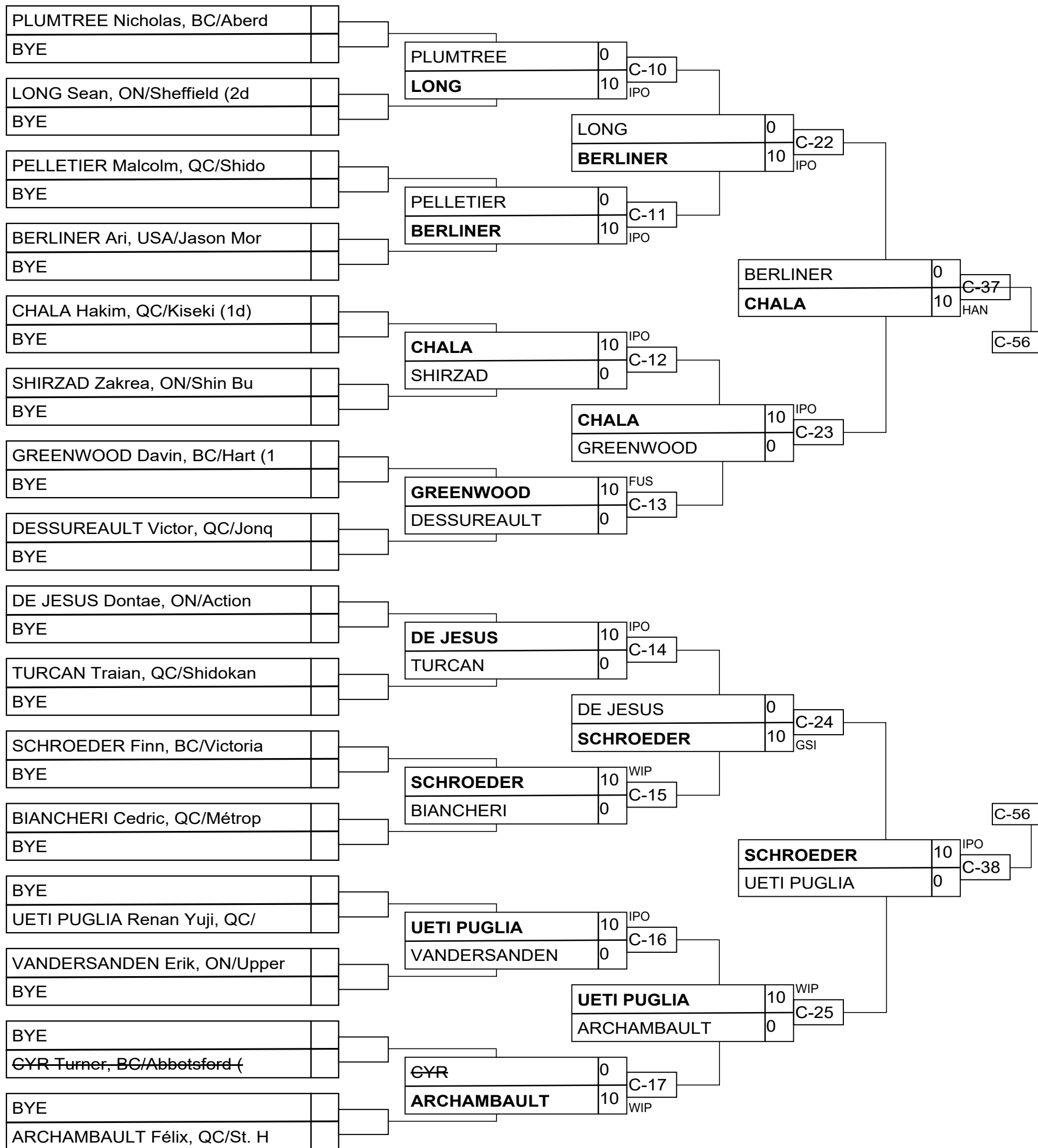

SenM -66

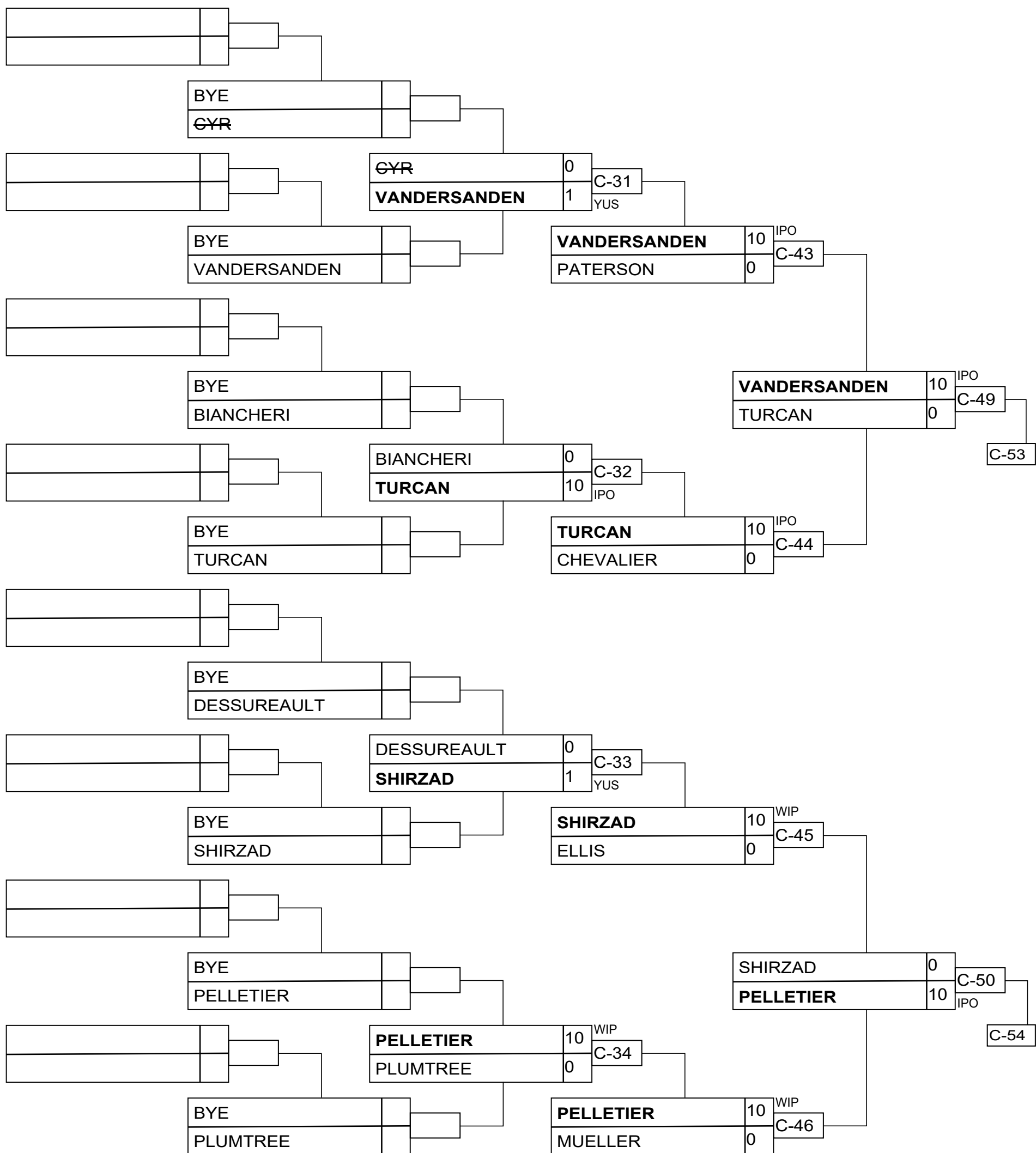

SenM -66

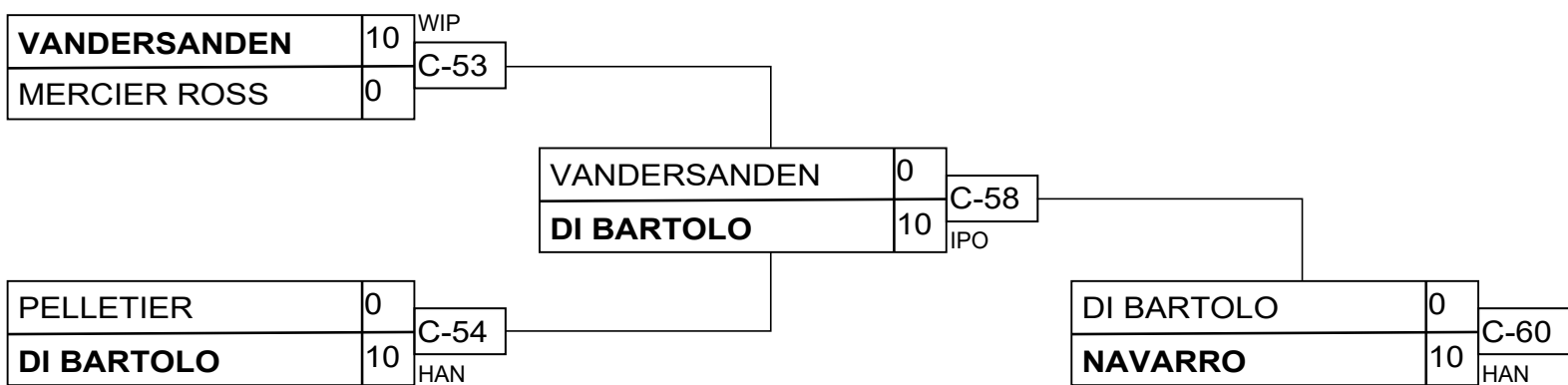
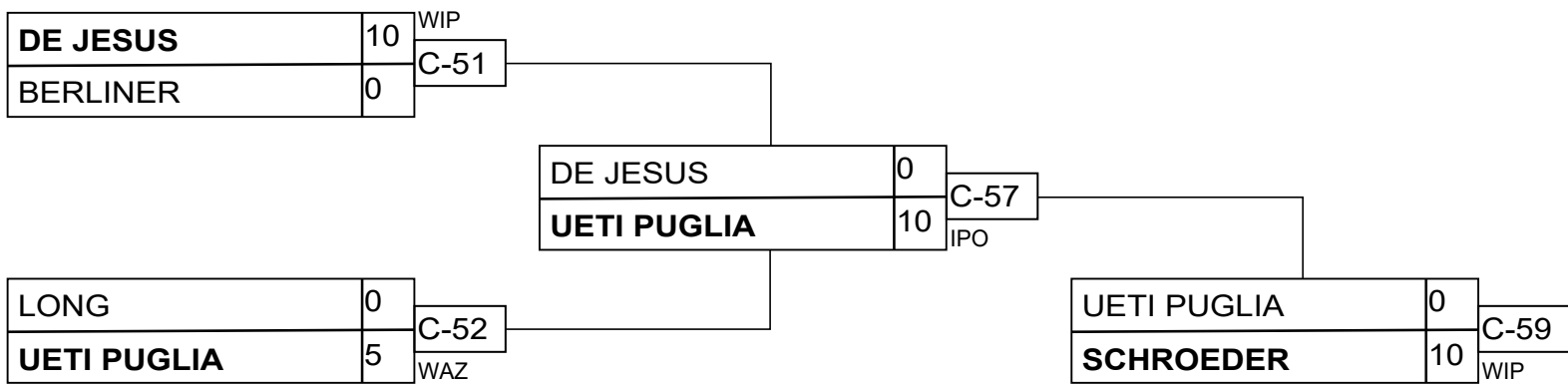
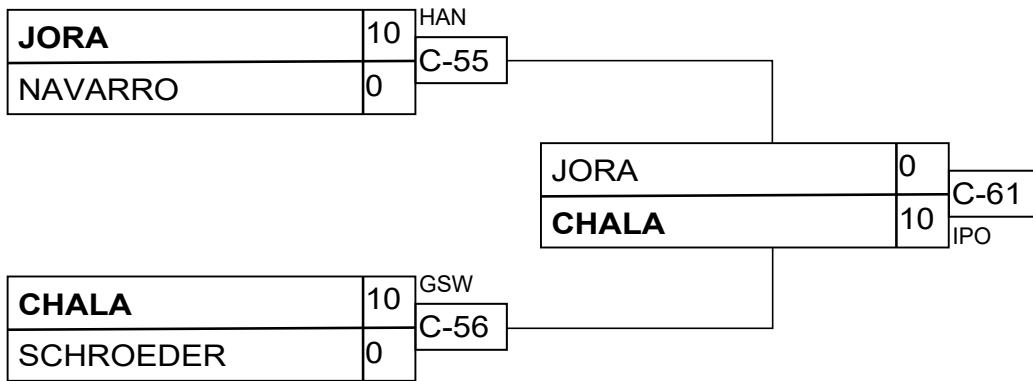

SenM -73

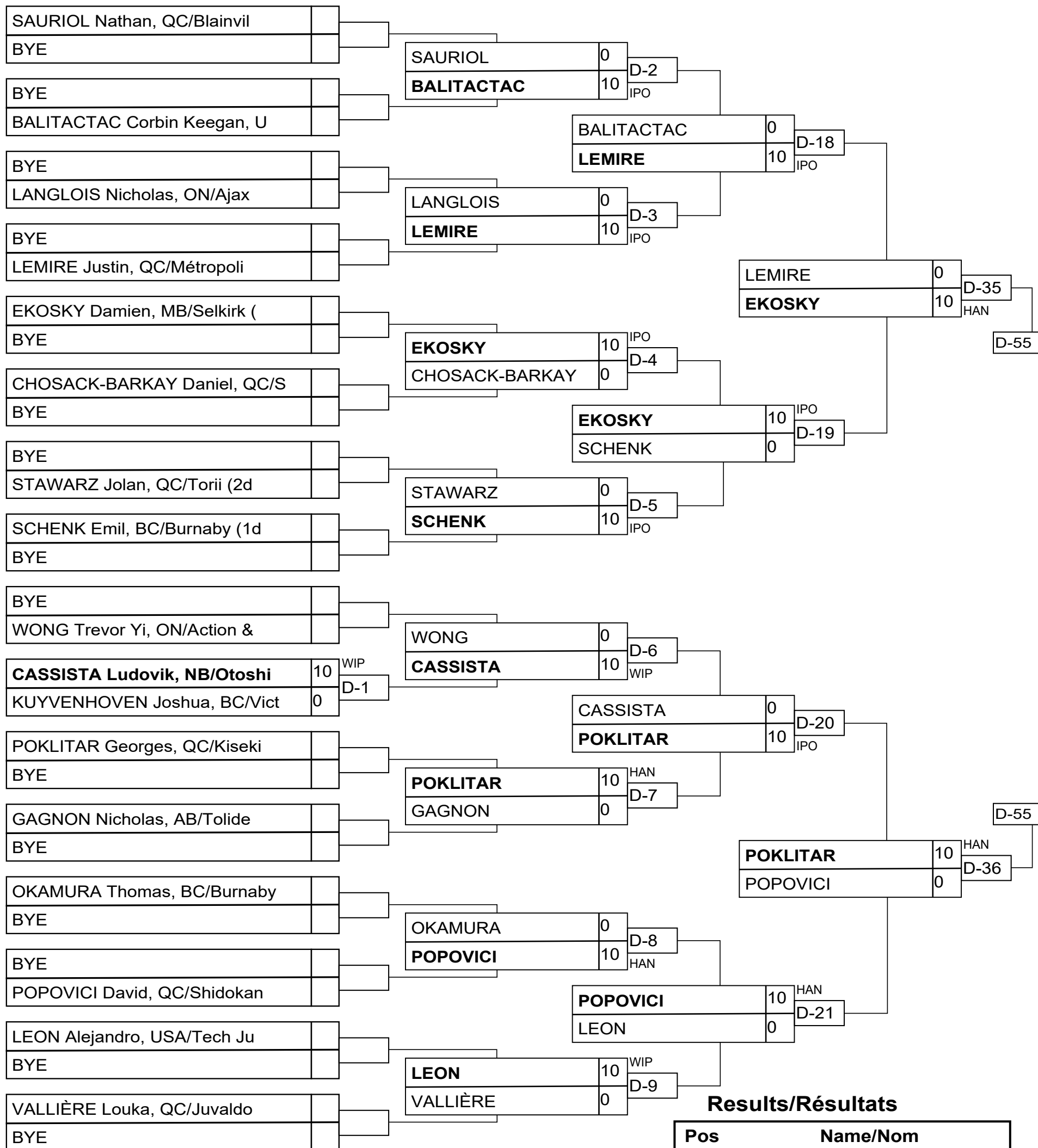

Results/Résultats

Pos	Name/Nom
1	JUTEAU Gabriel, QC/Bouch
2	POKLITAR Georges, QC/Kis
3	VACC Gabriel, QC/Olympiq
3	EKOSKY Damien, MB/Selkir

SenM -73

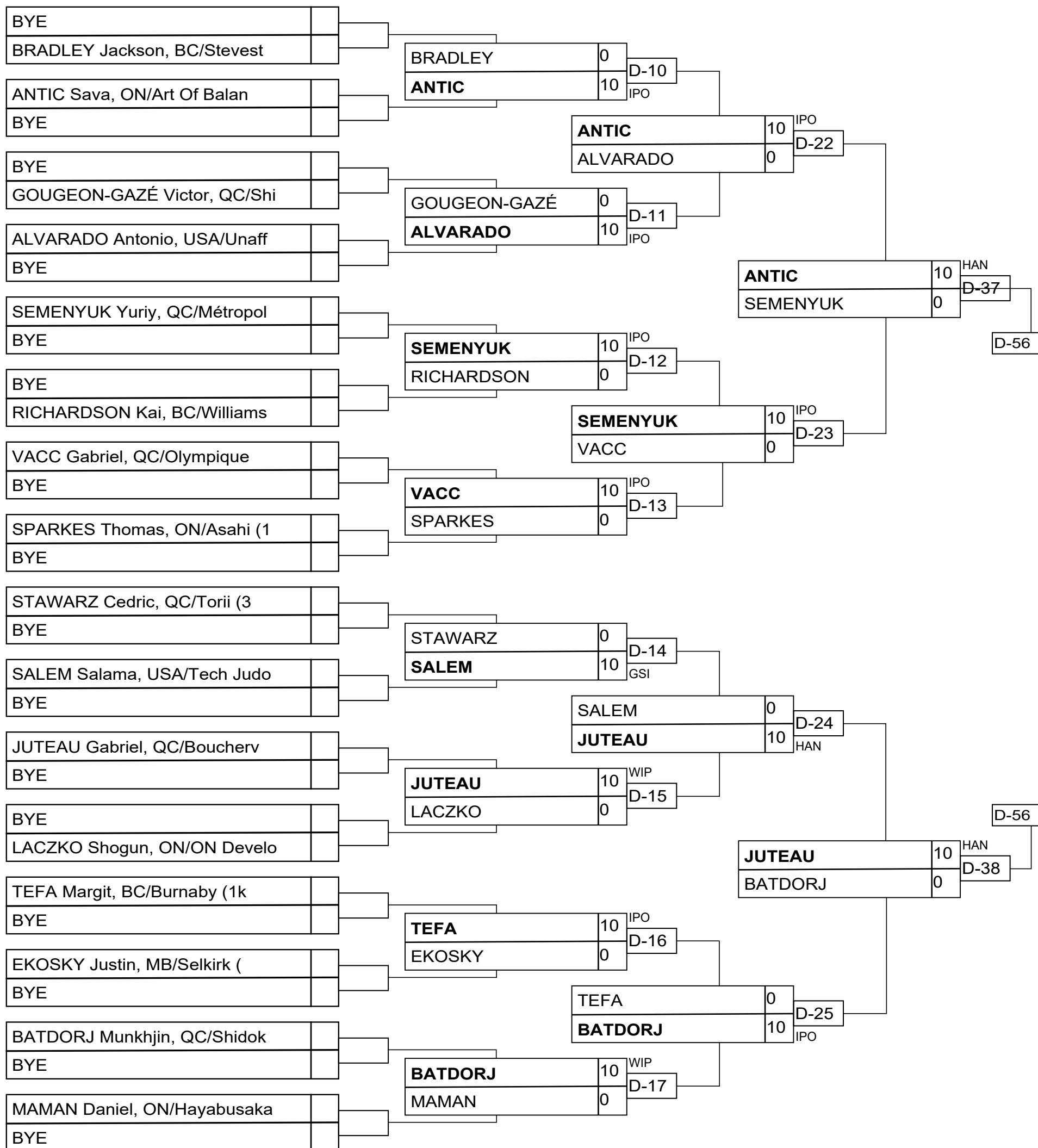

SenM -73

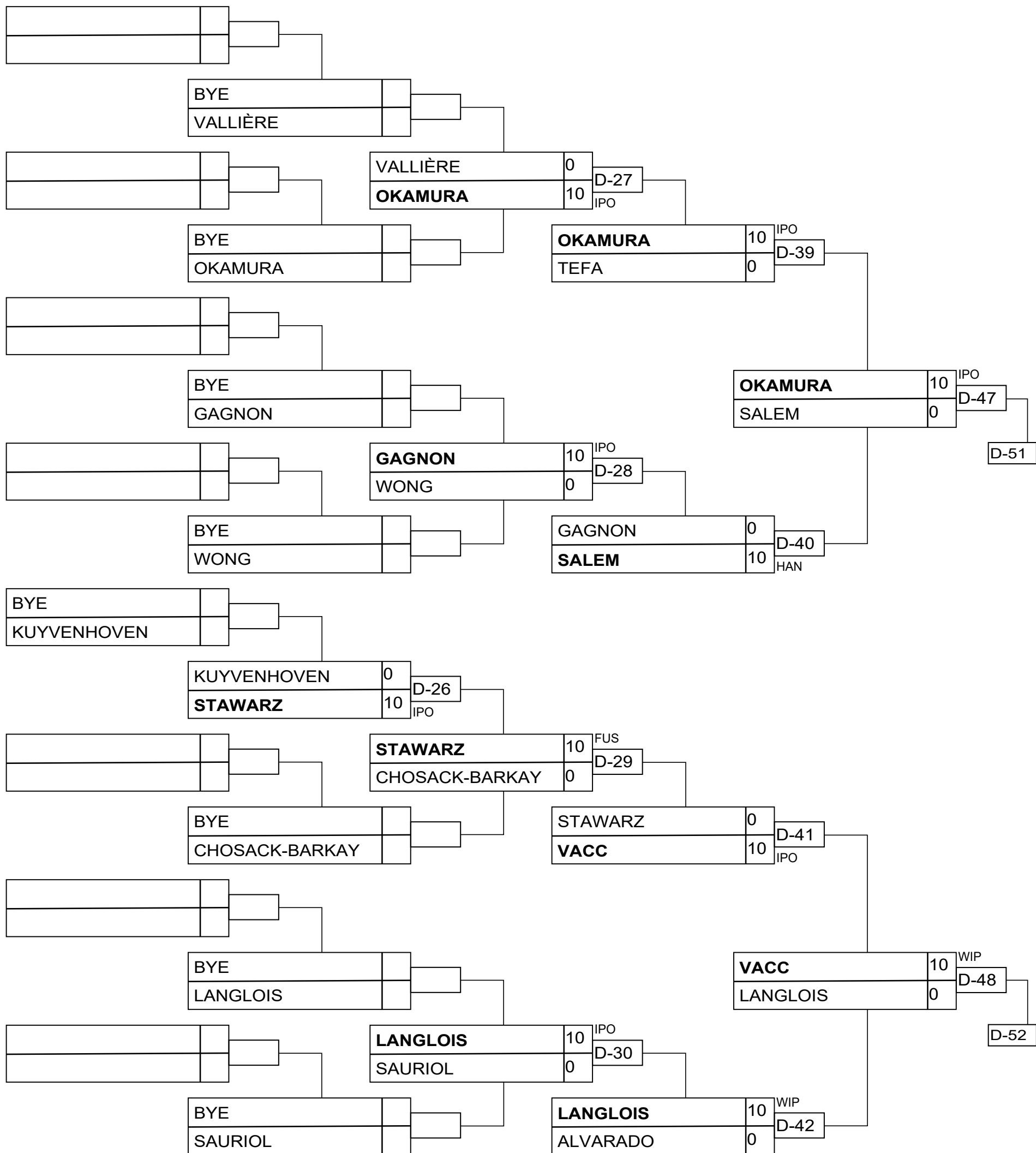

SenM -73

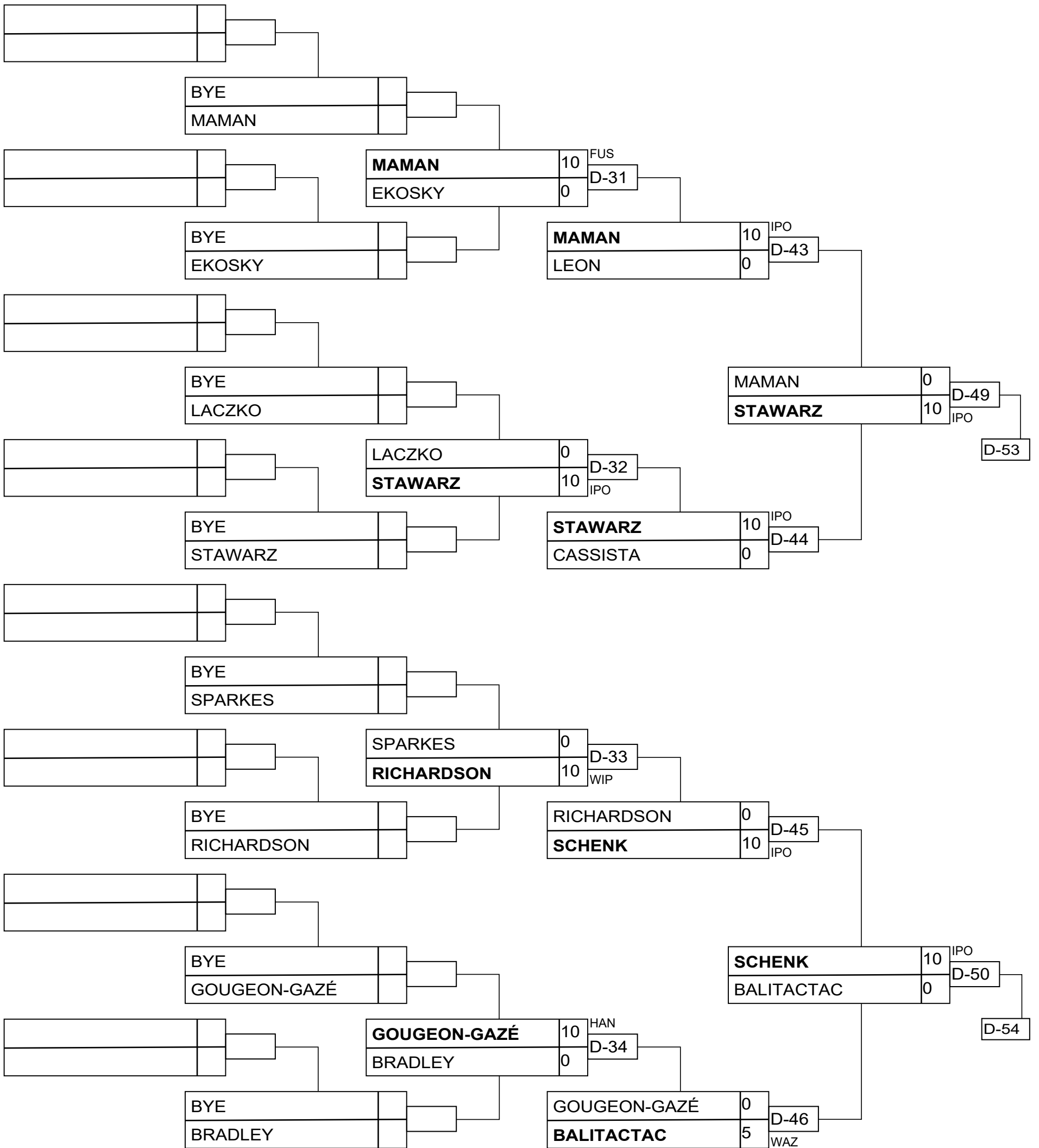

SenM -73

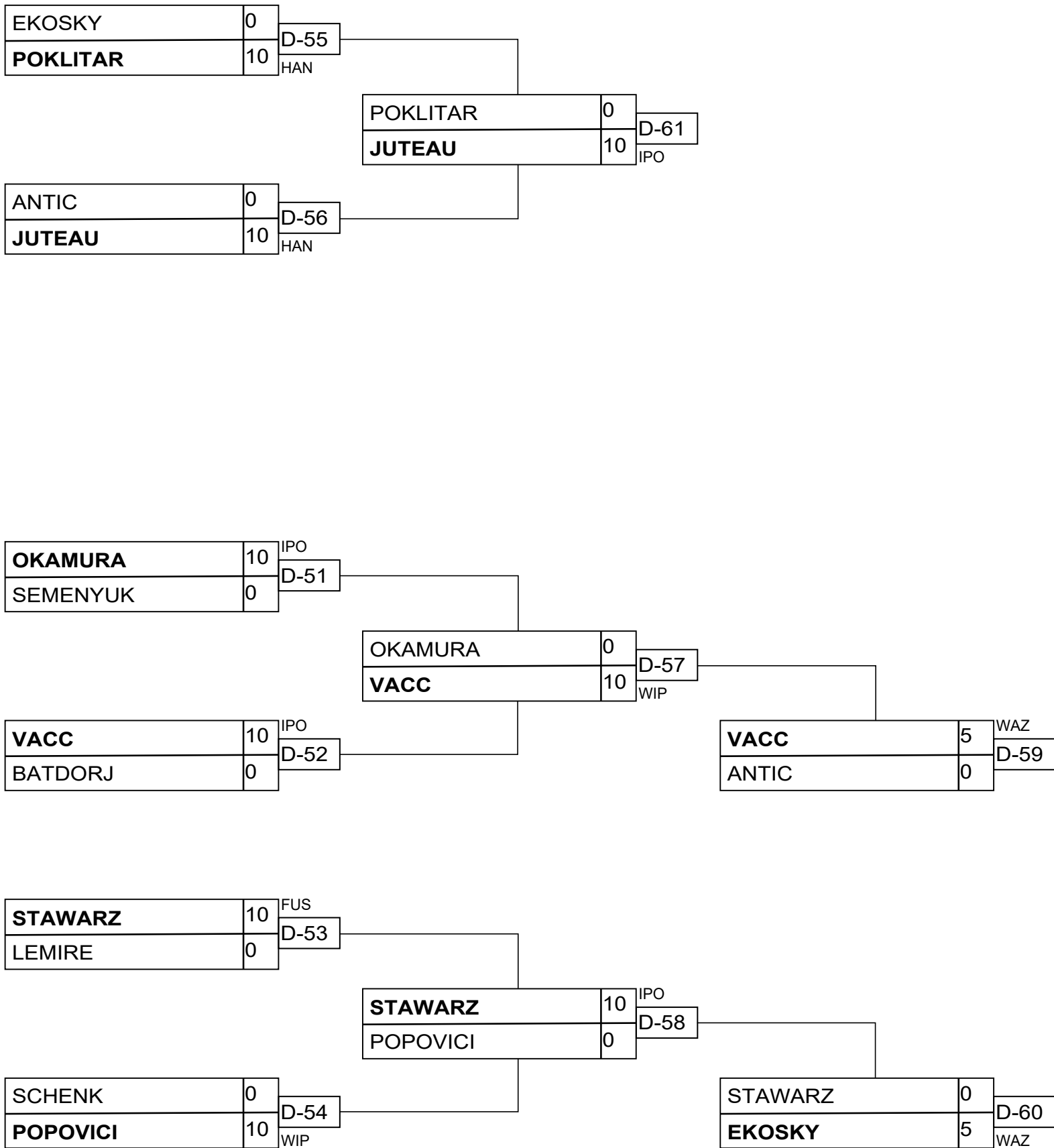

TT SenM -100

Competitors/Compétiteurs

#	Name/Nom	Grade	Club	1	2	3	W/G	Pts	Pos
1	ROBIN Alexis (0,00)	1d	QC/Olympique	XX	10	10	2	20	1
2	CHAMPAGNE Jérôme (0,00)	1k	QC/Varenes		XX		0	0	3
3	HURST Matt (0,00)	1d	NB/Dragons Judo Club		10	XX	1	10	2

Matches/Matches

Match	White/Blanc			Blue/Bleu	Res/Rés	Tim/Tmp	Code
B-53A	ROBIN Alexis	1	2	CHAMPAGNE Jérôme	10 - 0	2:40	GSI
B-58A	ROBIN Alexis	1	3	HURST Matt	10 - 0	1:13	IPO
B-60	CHAMPAGNE Jérôme	2	3	HURST Matt	0 - 10	0:17	GSI

Results/Résultats

Pos	Name/Nom
1	ROBIN Alexis, QC/Olympique
2	HURST Matt, NB/Dragons Judo Club