

U21SENF -01

Compétiteurs

#	Nom	Grade	Club	1	2	1	2	1	2	Vic.	Pts	Pos
1	GAGNE Moira (62,00)	3k	QC/Albatros	XX		XX		XX				
2	LAVOIE Saskia (66,10)	3k	QC/Université Laval		XX		XX		XX			

Matches

Match	Blanc			Bleu	Résultat	Temps	Code
D-29	GAGNE Moira	1	2	LAVOIE Saskia			
D-41	LAVOIE Saskia	2	1	GAGNE Moira			
D-53	GAGNE Moira	1	2	LAVOIE Saskia			

Résultats

Pos	Nom

U21SENF -03

Compétiteurs

#	Nom	Grade	Club	1	2	1	2	1	2	Vic.	Pts	Pos
1	ALVES Esther (49,70)	4k	QC/Olympique	XX		XX		XX				
2	AMMARI Yasmine (55,00)	4k+	QC/CJCSHP		XX		XX		XX			

Matches

Match	Blanc			Bleu	Résultat	Temps	Code
A-29	ALVES Esther	1	2	AMMARI Yasmine			
A-38	AMMARI Yasmine	2	1	ALVES Esther			
A-49	ALVES Esther	1	2	AMMARI Yasmine			

Résultats

Pos	Nom

U21SENF -04

Compétiteurs

#	Nom	Grade	Club	1	2	1	2	1	2	Vic.	Pts	Pos
1	JACQUES Théodine (73,10)	3k	QC/St. Leonard	XX		XX		XX				
2	NGANKO GABETH Adora Willia	4k	QC/Metropolitain		XX		XX		XX			

Matches

Match	Blanc			Bleu	Résultat	Temps	Code
B-43	JACQUES Théodine	1	2	NGANKO GABETH Adora Williamson			
B-53	NGANKO GABETH Adora Williamson	2	1	JACQUES Théodine			
B-61	JACQUES Théodine	1	2	NGANKO GABETH Adora Williamson			

Résultats

Pos	Nom

U21SENF -05

Compétiteurs

#	Nom	Grade	Club	1	2	1	2	1	2	Vic.	Pts	Pos
1	TERRIEN Daphney (77,60)	2k	QC/CMR Saint-Jean	XX		XX		XX				
2	JACQUES Théodine (73,10)	3k	QC/St. Leonard		XX		XX		XX			

Matches

Match	Blanc			Bleu	Résultat	Temps	Code
B-18	TERRIEN Daphney	1	2	JACQUES Théodine			
B-28	JACQUES Théodine	2	1	TERRIEN Daphney			
B-37	TERRIEN Daphney	1	2	JACQUES Théodine			

Résultats

Pos	Nom

U21SENF -48kg 2k+

Compétiteurs

#	Nom	Grade	Club	1	2	1	2	1	2	Vic.	Pts	Pos
1	DELYE Maria-Magdaleina (43)	2k	QC/Shidokan	XX		XX		XX				
2	GAGNE Emilie (46,40)	2k	QC/Albatros		XX		XX		XX			

Matches

Match	Blanc			Bleu	Résultat	Temps	Code
B-42	DELYE Maria-Magdaleina	1	2	GAGNE Emilie			
B-52	GAGNE Emilie	2	1	DELYE Maria-Magdaleina			
B-60	DELYE Maria-Magdaleina	1	2	GAGNE Emilie			

Résultats

Pos	Nom

U21SENF -52kg 2k+

Compétiteurs

#	Nom	Grade	Club	1	2	1	2	1	2	Vic.	Pts	Pos
1	NAIT SAID Yasmine (51,10)	2k	QC/St. Leonard	XX		XX		XX				
2	MCCRISTALL Angelina (48,90)	1D	ON/Upper Canada		XX		XX		XX			

Matches

Match	Blanc			Bleu	Résultat	Temps	Code
A-37	NAIT SAID Yasmine	1	2	MCCRISTALL Angelina			
A-48	MCCRISTALL Angelina	2	1	NAIT SAID Yasmine			
A-57	NAIT SAID Yasmine	1	2	MCCRISTALL Angelina			

Résultats

Pos	Nom

U21SENF -57kg 2k+

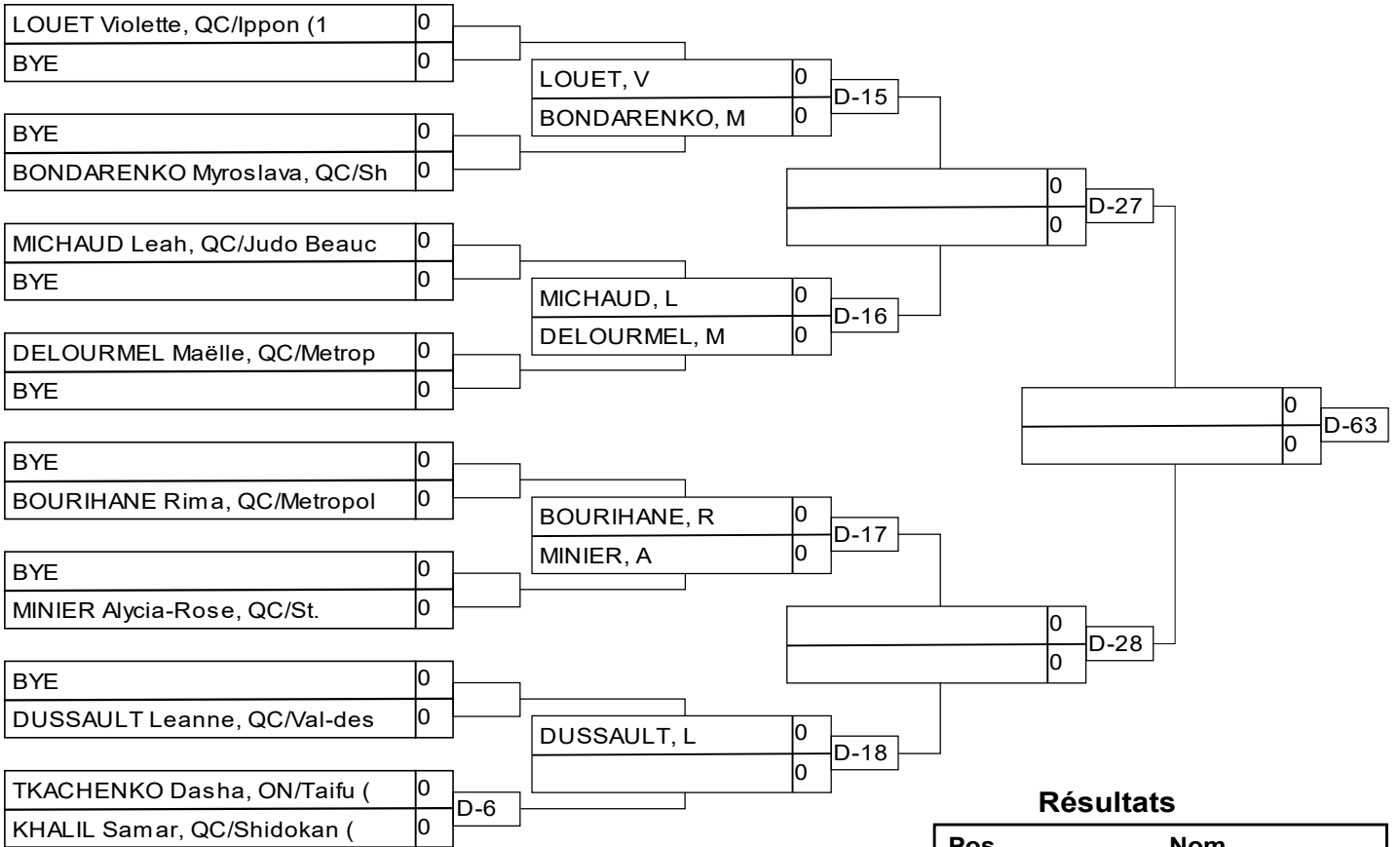

Résultats

Pos	Nom
1	
2	
3	
3	

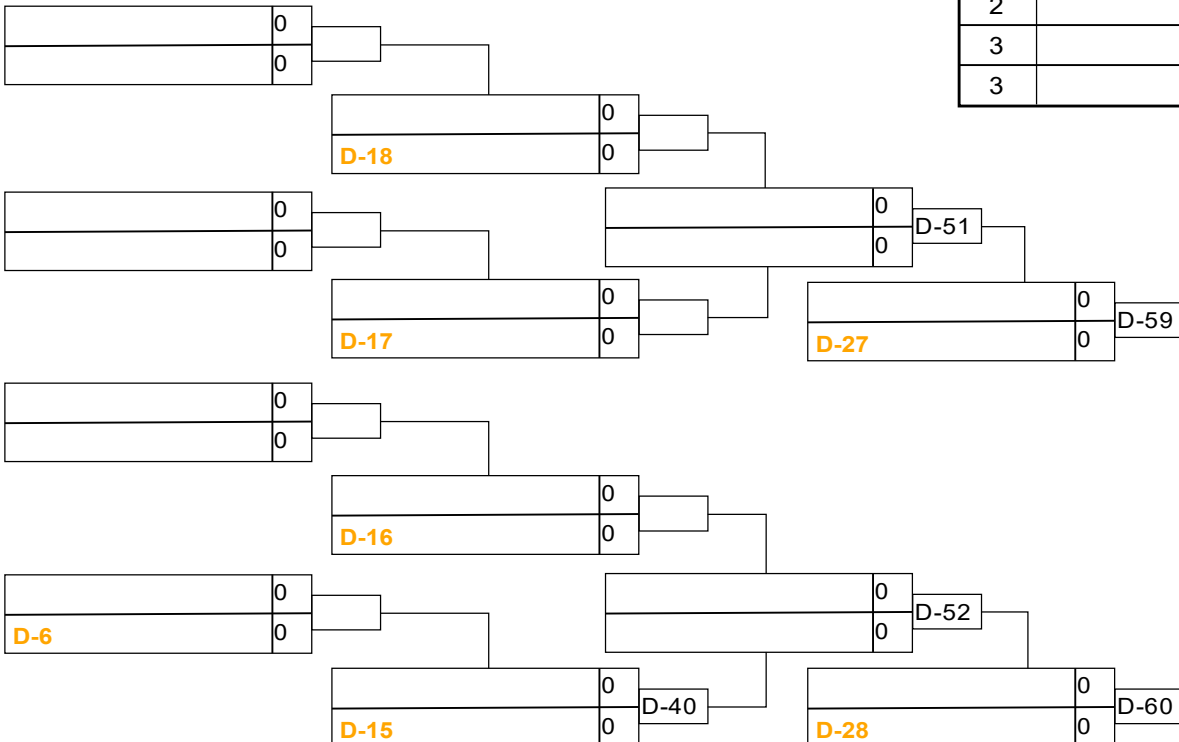

U21SENF -63kg 2k+

Compétiteurs A

#	Nom	Grade	Club	1	2	3	Vic.	Pts	Pos
1	TKACHENKO Alyssa (61,50)	1k	ON/Taifu	XX					
2	GAULIN Katherine (61,80)	1k	QC/Juvaldo		XX				
3	COUTURE Métis (62,80)	1D	QC/Judo Beauce			XX			

Pool A

Match	Blanc	Bleu	Résultat	Temps	Code
A-32	TKACHENKO Alyssa	1 2 GAULIN Katherine			
A-43	TKACHENKO Alyssa	1 3 COUTURE Métis			
A-52	GAULIN Katherine	2 3 COUTURE Métis			

Compétiteurs B

#	Nom	Grade	Club	4	5	6	Vic.	Pts	Pos
4	NGOMBI Miguela (62,70)	1k	QC/Shidokan	XX					
5	MEZAOUR Camelia (62,60)	1D	QC/St. Leonard		XX				
6	LANOUILLE Lea (60,40)	2k	QC/Blainville			XX			

Pool B

Match	Blanc	Bleu	Résultat	Temps	Code
A-33	NGOMBI Miguela	4 5 MEZAOUR Camelia			
A-44	NGOMBI Miguela	4 6 LANOUILLE Lea			
A-53	MEZAOUR Camelia	5 6 LANOUILLE Lea			

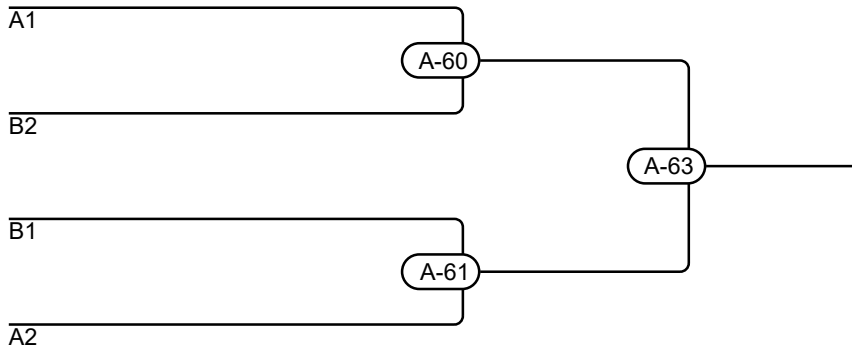

Résultats

Pos	Nom
1	
2	
3	
3	

U21SENF -70kg 2k+

Compétiteurs

#	Nom	Grade	Club	1	2	3	Vic.	Pts	Pos
1	DORVAL-MBELE Missy Jen (69)	1k	QC/Metropolitain	XX					
2	LAMRI Ralia (68,60)	1k	QC/Shidokan		XX				
3	MALIN Chloé (68,60)	1D	NT/Yellowknife			XX			

Matches

Match	Blanc			Bleu	Résultat	Temps	Code
A-34	DORVAL-MBELE Missy Jen	1	2	LAMRI Ralia			
A-45	DORVAL-MBELE Missy Jen	1	3	MALIN Chloé			
A-54	LAMRI Ralia	2	3	MALIN Chloé			

Résultats

Pos	Nom

U21SENM - 10

Compétiteurs

#	Nom	Grade	Club	1	2	3	4	Vic.	Pts	Pos
1	GAGNE Edouard (88,50)	4k	QC/CMR Saint-Jean	XX						
2	TCHAMENI MOKO Christian (8	5k	QC/CMR Saint-Jean		XX					
3	SAVARD Samy (86,90)	4k	QC/Olympique			XX				
4	ETZITIAN Raphaël (88,80)	5k	QC/CMR Saint-Jean				XX			

Matches

Match	Blanc			Bleu	Résultat	Temps	Code
C-35	GAGNE Edouard	1	2	TCHAMENI MOKO Christian			
C-36	SAVARD Samy	3	4	ETZITIAN Raphaël			
C-47	GAGNE Edouard	1	3	SAVARD Samy			
C-48	TCHAMENI MOKO Christian	2	4	ETZITIAN Raphaël			
C-57	GAGNE Edouard	1	4	ETZITIAN Raphaël			
C-58	TCHAMENI MOKO Christian	2	3	SAVARD Samy			

Résultats

Pos	Nom

U21SENM - 11

Compétiteurs

#	Nom	Grade	Club	1	2	3	4	Vic.	Pts	Pos
1	DODIER Alexis (94,10)	5k	QC/Univestrie/Donini	XX						
2	DERKAOUI Ayman-Naïm (89,90)	5k	QC/Kiseki		XX					
3	BIGNELL Benjamin (92,40)	5k	QC/Bushidokan			XX				
4	DJENADI Rayan (91,20)	5k	QC/CJCSHP				XX			

Matches

Match	Blanc			Bleu	Résultat	Temps	Code
D-25	DODIER Alexis	1	2	DERKAOUI Ayman-Naïm			
D-26	BIGNELL Benjamin	3	4	DJENADI Rayan			
D-38	DODIER Alexis	1	3	BIGNELL Benjamin			
D-39	DERKAOUI Ayman-Naïm	2	4	DJENADI Rayan			
D-49	DODIER Alexis	1	4	DJENADI Rayan			
D-50	DERKAOUI Ayman-Naïm	2	3	BIGNELL Benjamin			

Résultats

Pos	Nom

U21SENM - 12

Compétiteurs

#	Nom	Grade	Club	1	2	3	Vic.	Pts	Pos
1	MEHENNI Zakariya (111,70)	5k	QC/Bushidokan	XX					
2	BABAI Dariush (102,80)	4k+	QC/Budokai (QC)		XX				
3	DIMITRACOPOULOS Panayiotis	5k	Metropolitain			XX			

Matches

Match	Blanc			Bleu	Résultat	Temps	Code
D-22	MEHENNI Zakariya	1	2	BABAI Dariush			
D-36	MEHENNI Zakariya	1	3	DIMITRACOPOULOS Panayiotis			
D-46	BABAI Dariush	2	3	DIMITRACOPOULOS Panayiotis			

Résultats

Pos	Nom

U21SENM -01

Compétiteurs

#	Nom	Grade	Club	1	2	3	Vic.	Pts	Pos
1	SAIDI Kahled (55,60)	3k	QC/St. Paul-l'Ermite	XX					
2	VO David (51,30)	3k	QC/Jikan		XX				
3	ROUSSEL-CONTRERAS Isarael	5k	QC/CMR Saint-Jean			XX			

Matches

Match	Blanc			Bleu	Résultat	Temps	Code
D-30	SAIDI Kahled	1	2	VO David			
D-42	SAIDI Kahled	1	3	ROUSSEL-CONTRERAS Isarael			
D-54	VO David	2	3	ROUSSEL-CONTRERAS Isarael			

Résultats

Pos	Nom

U21SENM -02

Compétiteurs

#	Nom	Grade	Club	1	2	3	4	Vic.	Pts	Pos
1	BEAUDOIN Nicolas (65,80)	3k	QC/Univestrie/Donini	XX						
2	FORTIN Paul-Emeric (65,30)	3k	QC/Université Laval		XX					
3	DEPANI Mario (65,60)	3k	QC/Torii			XX				
4	BOUTERFA Madjid (60,70)	3k	QC/Blainville				XX			

Matches

Match	Blanc			Bleu	Résultat	Temps	Code
C-32	BEAUDOIN Nicolas	1	2	FORTIN Paul-Emeric			
C-33	DEPANI Mario	3	4	BOUTERFA Madjid			
C-44	BEAUDOIN Nicolas	1	3	DEPANI Mario			
C-45	FORTIN Paul-Emeric	2	4	BOUTERFA Madjid			
C-54	BEAUDOIN Nicolas	1	4	BOUTERFA Madjid			
C-55	FORTIN Paul-Emeric	2	3	DEPANI Mario			

Résultats

Pos	Nom

U21SENM -03

Compétiteurs

#	Nom	Grade	Club	1	2	3	Vic.	Pts	Pos
1	AGOPIAN Hovanness (72,30)	3k	QC/Ararat	XX					
2	KOSTENKO Borys (72,80)	3k	QC/Ippon		XX				
3	FECTEAU Guillaume (70,10)	3k	QC/To Haku Kan			XX			

Matches

Match	Blanc			Bleu	Résultat	Temps	Code
D-19	AGOPIAN Hovanness	1	2	KOSTENKO Borys			
D-31	AGOPIAN Hovanness	1	3	FECTEAU Guillaume			
D-43	KOSTENKO Borys	2	3	FECTEAU Guillaume			

Résultats

Pos	Nom

U21SENM -04

Compétiteurs

#	Nom	Grade	Club	1	2	3	Vic.	Pts	Pos
1	LAFLAMME Thomas (72,80)	3k	QC/Rouyn-Noranda	XX					
2	GAMACHE Samuel (72,90)	3k	QC/Judo Monde		XX				
3	ALAZZOUZI Adam Ryan (73,30)	3k	QC/Metropolitain			XX			

Matches

Match	Blanc			Bleu	Résultat	Temps	Code
C-31	LAFLAMME Thomas	1	2	GAMACHE Samuel			
C-43	LAFLAMME Thomas	1	3	ALAZZOUZI Adam Ryan			
C-53	GAMACHE Samuel	2	3	ALAZZOUZI Adam Ryan			

Résultats

Pos	Nom

U21SENM -05

Compétiteurs

#	Nom	Grade	Club	1	2	3	4	5	Vic.	Pts	Pos
1	ABDELTIF Mostefa Camil (89)	3k	QC/CJCSHP	XX							
2	NAHAYO Allen (94,70)	3k	QC/Budokai (QC)		XX						
3	ST-LAURENT Jean - Francois	3k	QC/Tritton			XX					
4	BUREAU-LAPOINTE Thomas (88)	3k	QC/Univestrie/Donini				XX				
5	MICHAUD Samuel (87,60)	3k	QC/Baie-Comeau					XX			

Matches

Match	Blanc			Bleu	Résultat	Temps	Code
C-16	BUREAU-LAPOINTE Thomas	4	5	MICHAUD Samuel			
C-17	ABDELTIF Mostefa Camil	1	2	NAHAYO Allen			
C-21	ST-LAURENT Jean - Francois	3	4	BUREAU-LAPOINTE Thomas			
C-22	ABDELTIF Mostefa Camil	1	5	MICHAUD Samuel			
C-27	NAHAYO Allen	2	3	ST-LAURENT Jean - Francois			
C-28	ABDELTIF Mostefa Camil	1	4	BUREAU-LAPOINTE Thomas			
C-37	ST-LAURENT Jean - Francois	3	5	MICHAUD Samuel			
C-38	NAHAYO Allen	2	4	BUREAU-LAPOINTE Thomas			
C-49	ABDELTIF Mostefa Camil	1	3	ST-LAURENT Jean - Francois			
C-50	NAHAYO Allen	2	5	MICHAUD Samuel			

Résultats

Pos	Nom

U21SENM -08

Compétiteurs

#	Nom	Grade	Club	1	2	3	4	Vic.	Pts	Pos
1	ROBERGE Alexis (71,60)	5k	QC/CMR Saint-Jean	XX						
2	LÉTOURNEAU Charles-Olivier	4k	QC/CMR Saint-Jean		XX					
3	VUKOVIC Djurica (64,60)	4k	QC/Shidokan			XX				
4	ELIBERT Anthony (70,70)	5k	QC/Bushidokan				XX			

Matches

Match	Blanc			Bleu	Résultat	Temps	Code
A-35	ROBERGE Alexis	1	2	LÉTOURNEAU Charles-Olivier			
A-36	VUKOVIC Djurica	3	4	ELIBERT Anthony			
A-46	ROBERGE Alexis	1	3	VUKOVIC Djurica			
A-47	LÉTOURNEAU Charles-Olivier	2	4	ELIBERT Anthony			
A-55	ROBERGE Alexis	1	4	ELIBERT Anthony			
A-56	LÉTOURNEAU Charles-Olivier	2	3	VUKOVIC Djurica			

Résultats

Pos	Nom

U21SENM -09

Compétiteurs

#	Nom	Grade	Club	1	2	3	Vic.	Pts	Pos
1	FERREIRA-LEAO Guilherme (7)	4k	QC/Judo Monde	XX					
2	PAYEUR Jean-Christophe (78)	4k	QC/Budokai (QC)		XX				
3	DAVE Soham (72,90)	4k	ON/Ottawa			XX			

Matches

Match	Blanc			Bleu	Résultat	Temps	Code
C-34	FERREIRA-LEAO Guilherme	1	2	PAYEUR Jean-Christophe			
C-46	FERREIRA-LEAO Guilherme	1	3	DAVE Soham			
C-56	PAYEUR Jean-Christophe	2	3	DAVE Soham			

Résultats

Pos	Nom

U21SENM -100kg 2k+

Compétiteurs

#	Nom	Grade	Club	1	2	3	4	Vic.	Pts	Pos
1	CHELFI Kevin (97,90)	1k	QC/Verdun	XX						
2	MADUMBA George (98,30)	1D	QC/Tritton		XX					
3	KHALFON Eden (94,20)	1k	Taifu			XX				
4	CIUPE Alex Jr (96,70)	1k	QC/Shidokan				XX			

Matches

Match	Blanc			Bleu	Résultat	Temps	Code
B-40	CHELFI Kevin	1	2	MADUMBA George			
B-41	KHALFON Eden	3	4	CIUPE Alex Jr			
B-50	CHELFI Kevin	1	3	KHALFON Eden			
B-51	MADUMBA George	2	4	CIUPE Alex Jr			
B-58	CHELFI Kevin	1	4	CIUPE Alex Jr			
B-59	MADUMBA George	2	3	KHALFON Eden			

Résultats

Pos	Nom

U21SENM -60kg 2k+

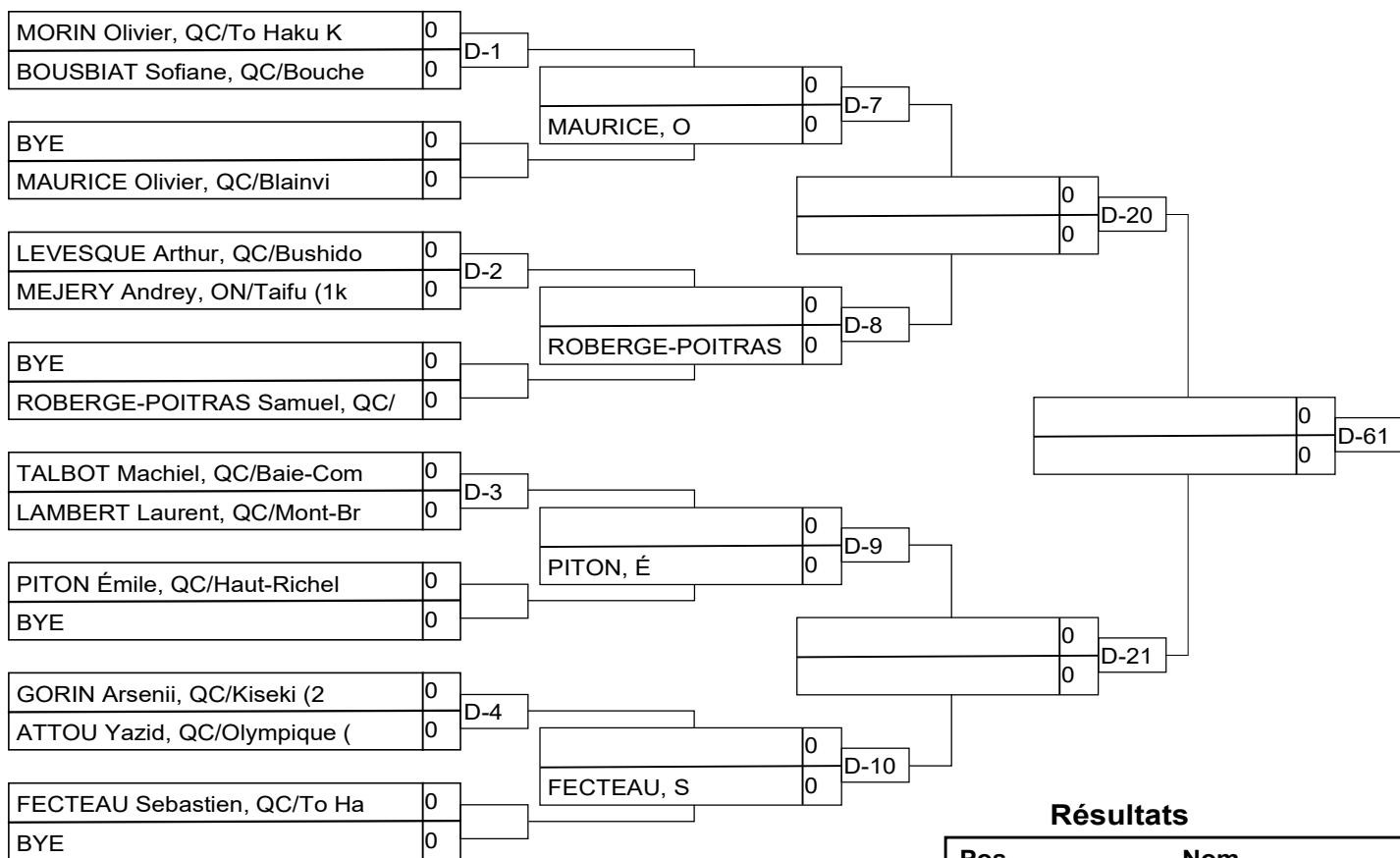

Résultats

Pos	Nom
1	
2	
3	
3	

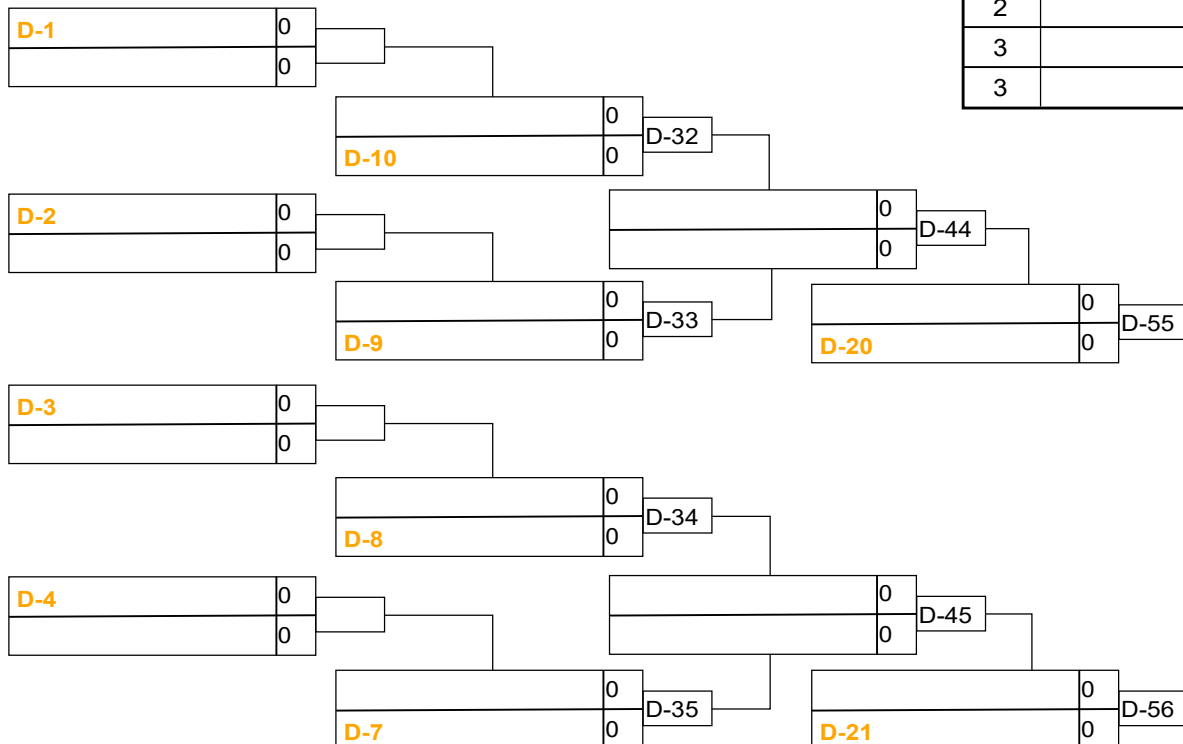

U21SENM -66kg 2k+

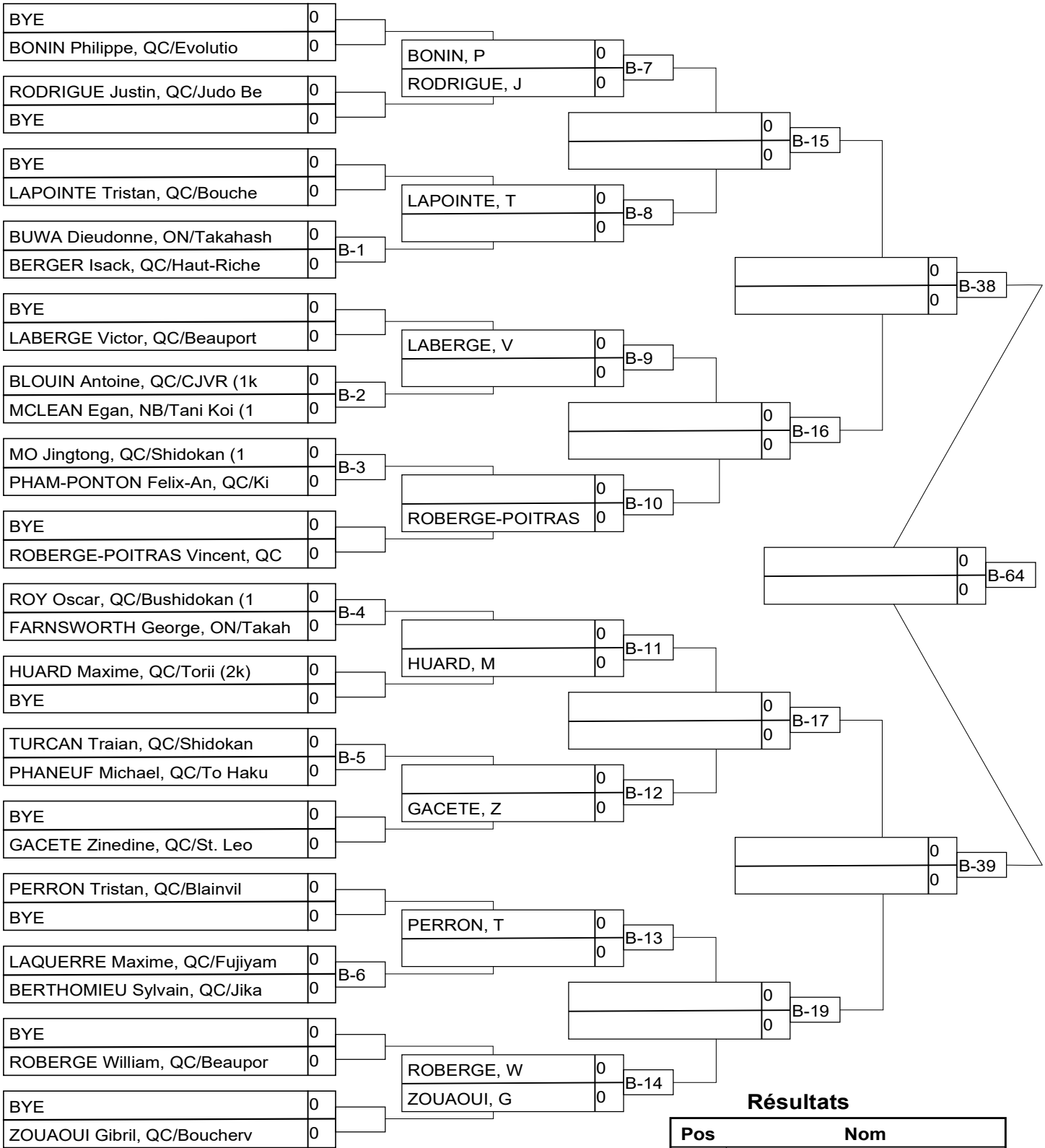

Résultats

Pos	Nom
1	
2	
3	
3	

U21SENM -66kg 2k+

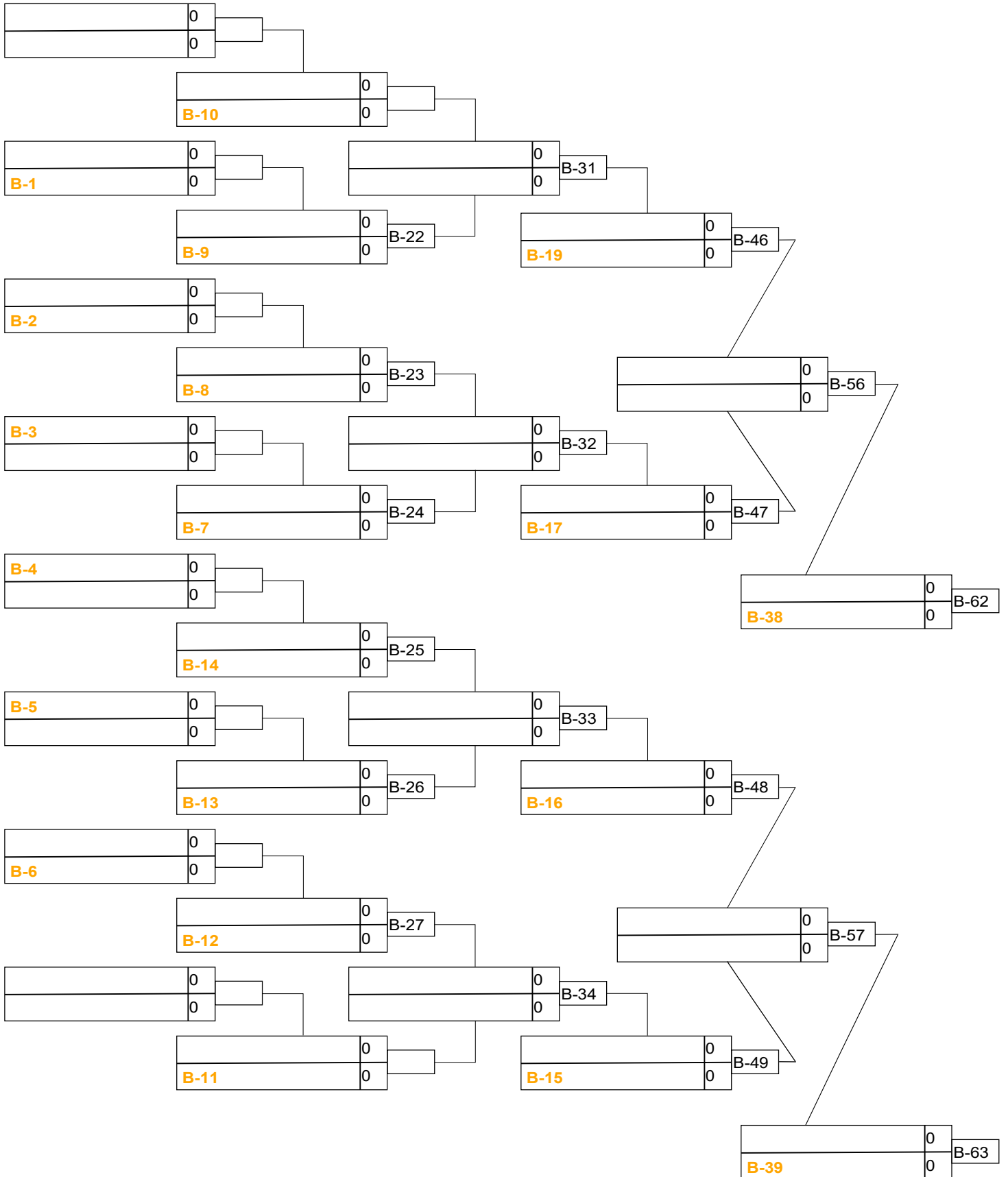

U21SENM -73kg 2k+

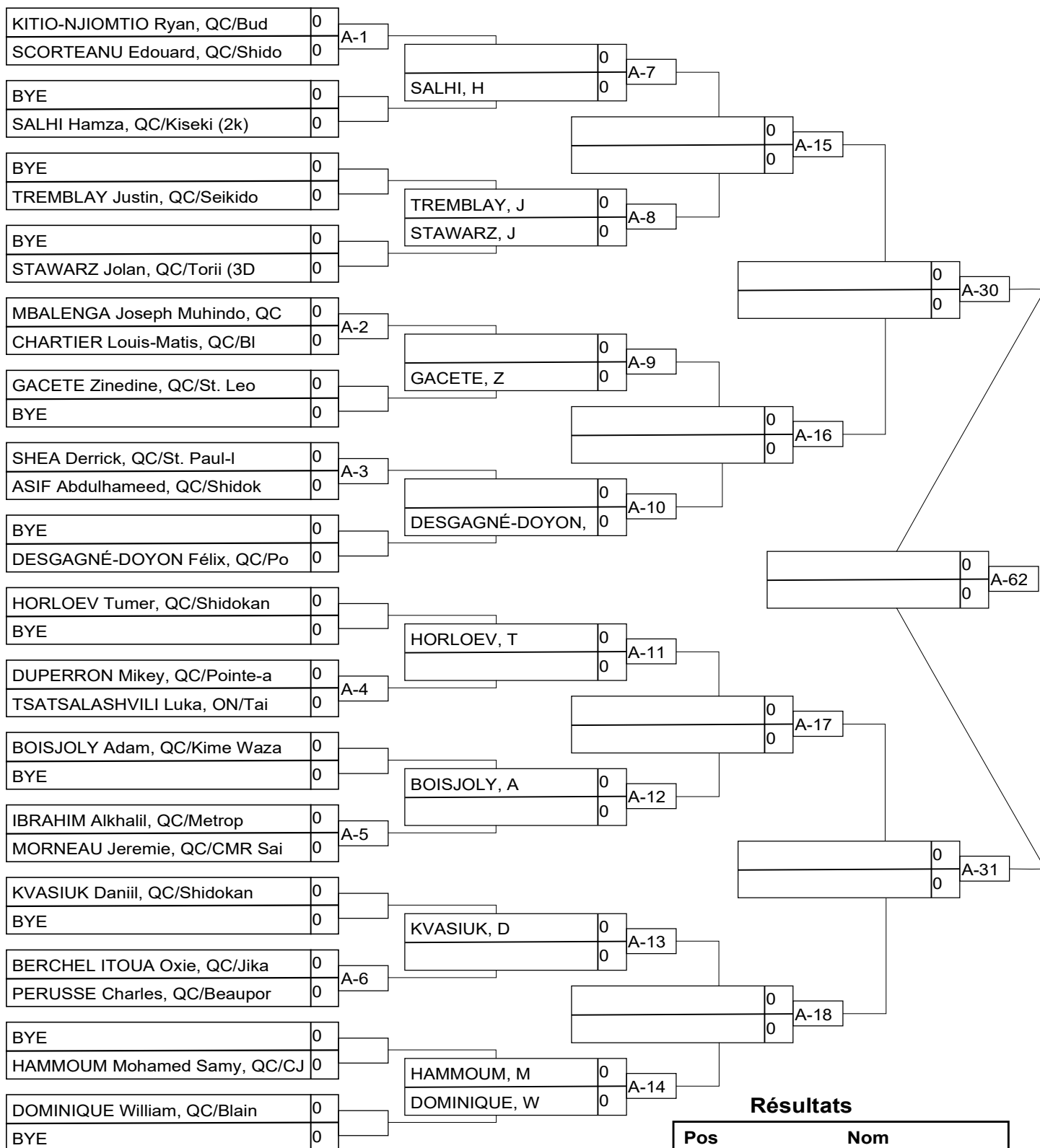

Résultats

Pos	Nom
1	
2	
3	
3	

U21SENM -73kg 2k+

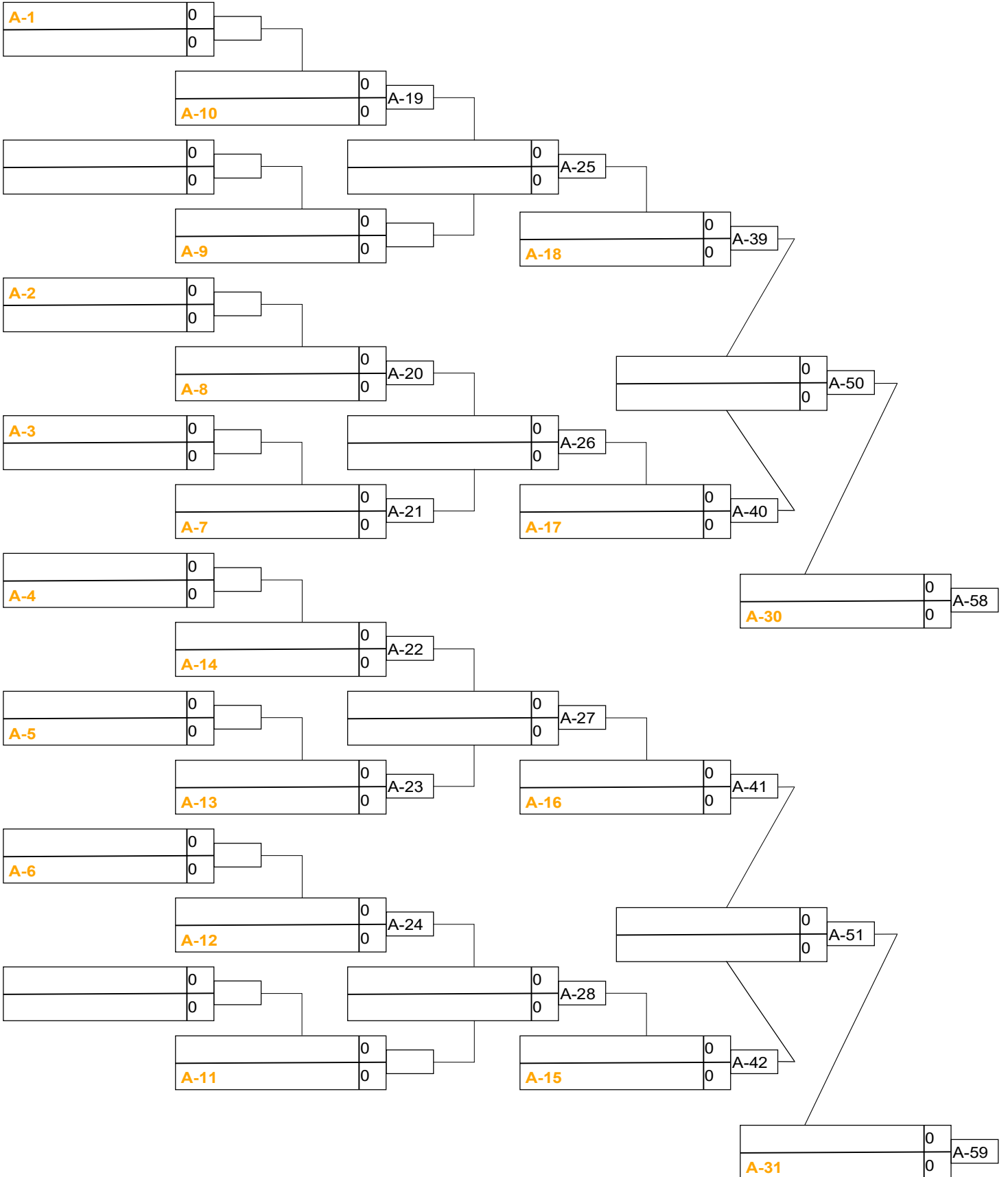

U21SENM -81kg 2k+

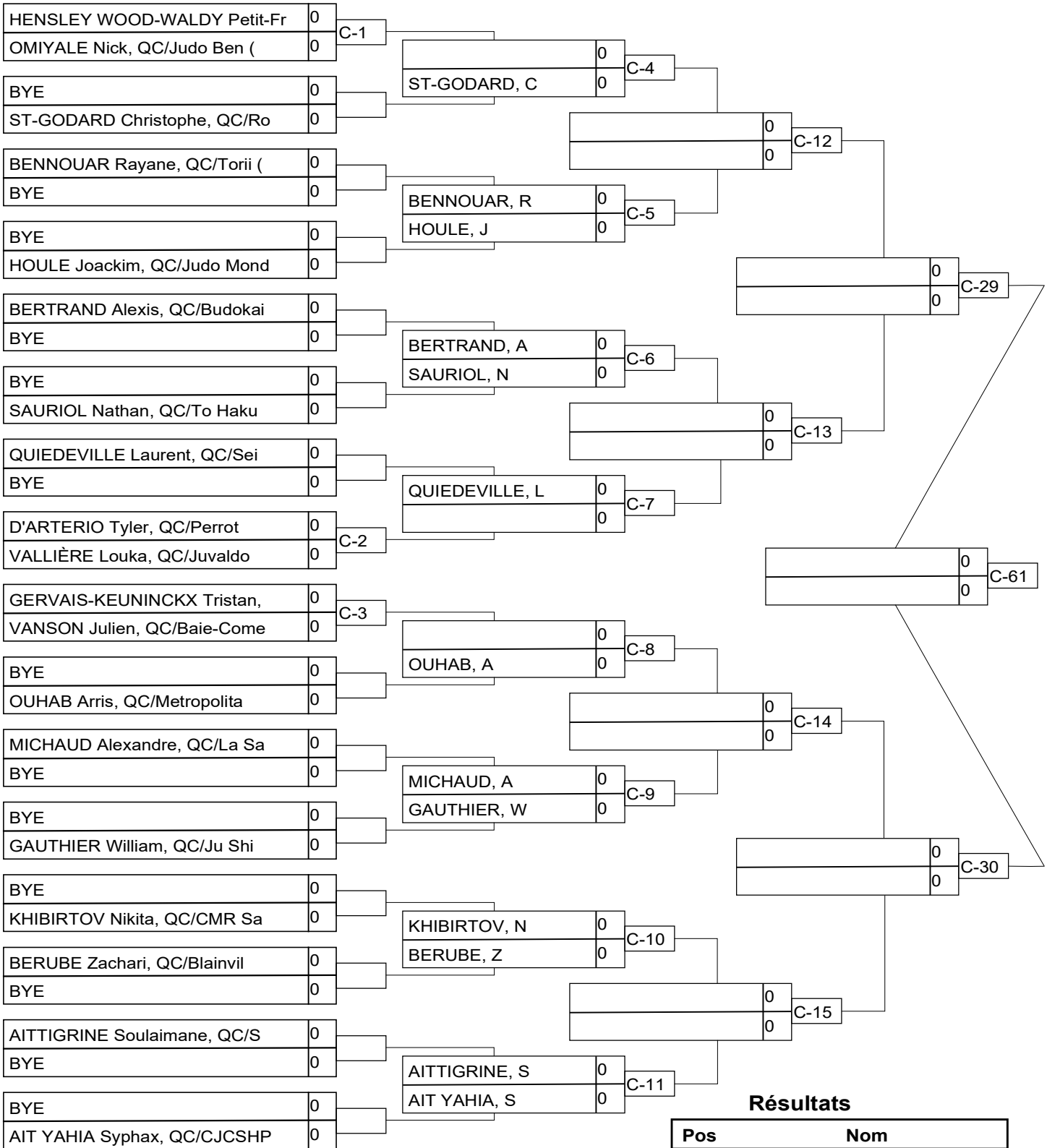

Résultats

Pos	Nom
1	
2	
3	
3	

U21SENM -81kg 2k+

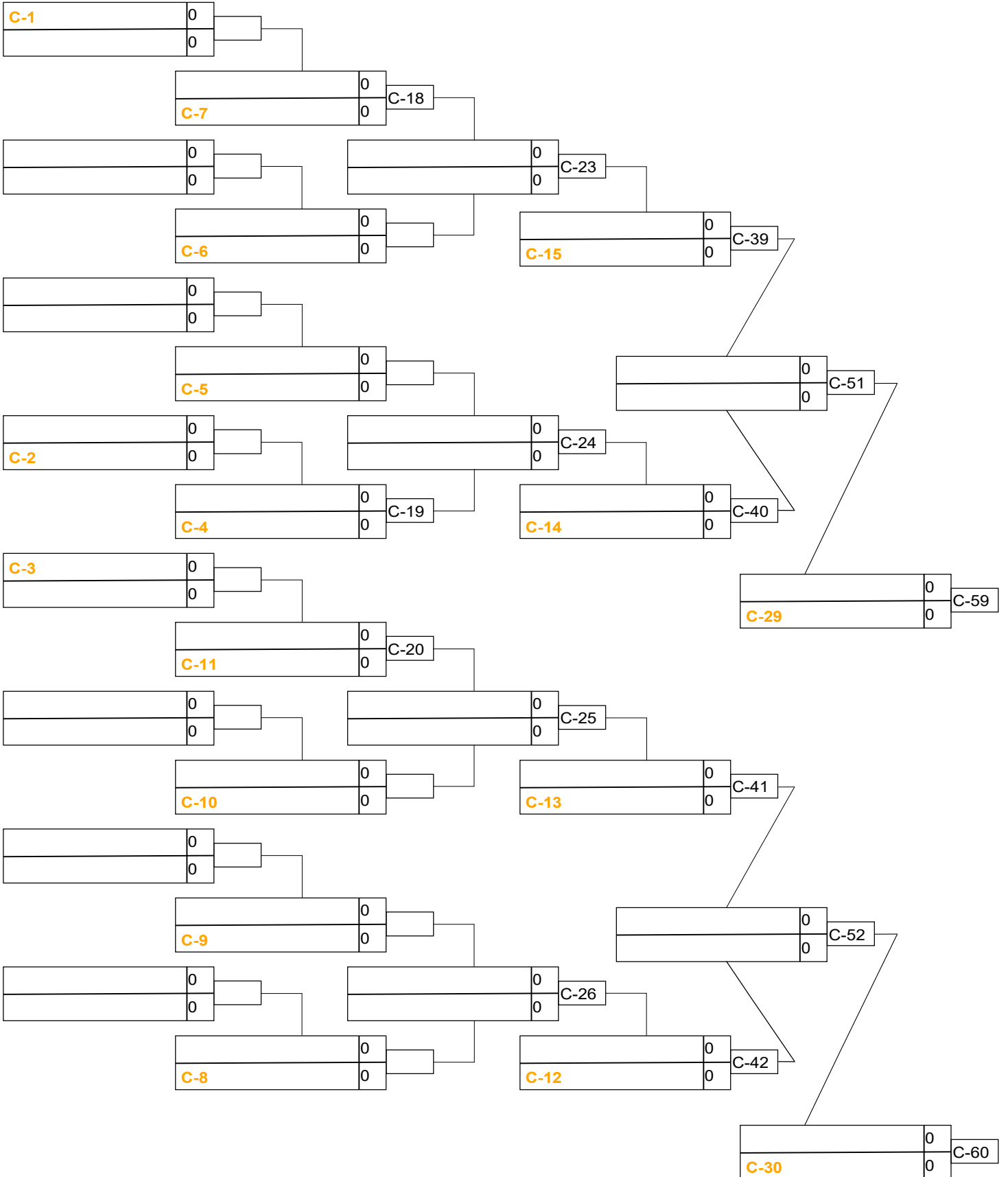

U21SENM -90kg 2k+

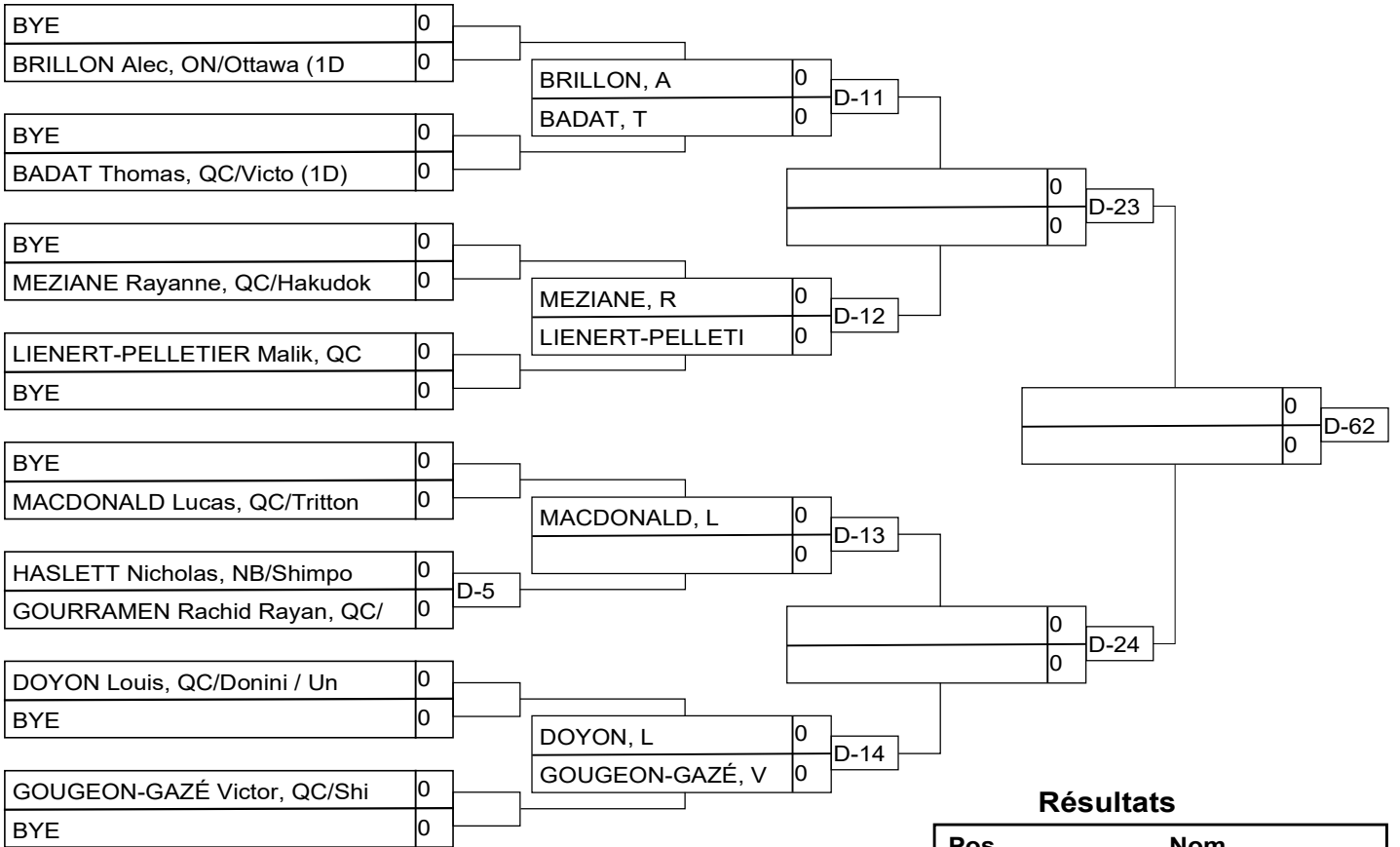

Résultats

Pos	Nom
1	
2	
3	
3	

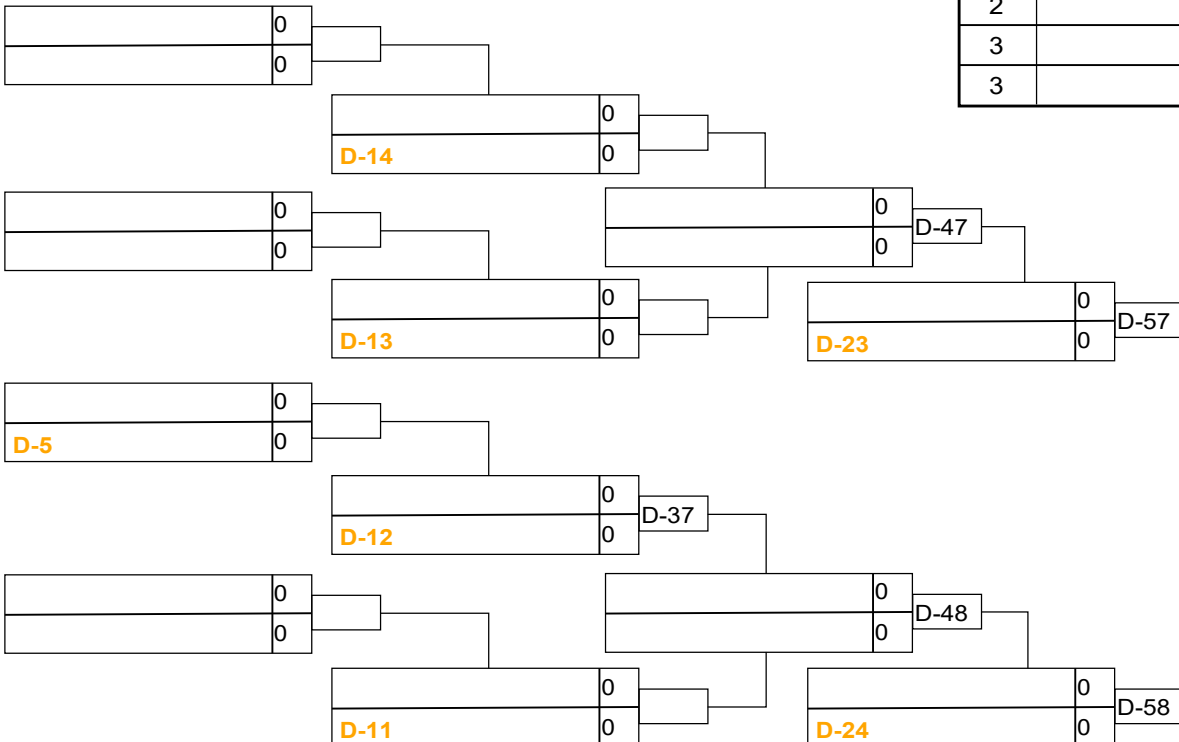

U21SENM 100kg 2k+

Compétiteurs

#	Nom	Grade	Club	1	2	3	4	5	Vic.	Pts	Pos
1	GIMENEZ COMAS Agustin (116)	1k	QC/Shidokan	XX							
2	BÉLAL Rayan (143,80)	1k	QC/Olympique		XX						
3	KHAVERI Sajjad (126,10)	1k	QC/Univestrie/Donini			XX					
4	ARENCIBIA Leo (116,60)	1D	QC/Shidokan				XX				
5	CALLEJA Matias Ramon (112,	1k	QC/Shidokan					XX			

Matches

Match	Blanc			Bleu	Résultat	Temps	Code
B-20	ARENCIBIA Leo	4	5	CALLEJA Matias Ramon			
B-21	GIMENEZ COMAS Agustin	1	2	BÉLAL Rayan			
B-29	KHAVERI Sajjad	3	4	ARENCIBIA Leo			
B-30	GIMENEZ COMAS Agustin	1	5	CALLEJA Matias Ramon			
B-35	BÉLAL Rayan	2	3	KHAVERI Sajjad			
B-36	GIMENEZ COMAS Agustin	1	4	ARENCIBIA Leo			
B-44	KHAVERI Sajjad	3	5	CALLEJA Matias Ramon			
B-45	BÉLAL Rayan	2	4	ARENCIBIA Leo			
B-54	GIMENEZ COMAS Agustin	1	3	KHAVERI Sajjad			
B-55	BÉLAL Rayan	2	5	CALLEJA Matias Ramon			

Résultats

Pos	Nom