

U14F - 01

Compétiteurs

#	Nom	Grade	Club	1	2	3	Vic.	Pts	Pos
1	VIEL Marie-Soleil (35,60)	4k	QC/Jonquiere	XX					
2	DESCHENES Zoe (33,60)	4k	QC/Baie-Comeau		XX				
3	PERRON Alice (33,70)	4k+	QC/Ju Shin Kan			XX			

Matches

Match	Blanc			Bleu	Résultat	Temps	Code
D-17	VIEL Marie-Soleil	1	2	DESCHENES Zoe			
D-28	VIEL Marie-Soleil	1	3	PERRON Alice			
D-41	DESCHENES Zoe	2	3	PERRON Alice			

Résultats

Pos	Nom

U14F - 02

Compétiteurs

#	Nom	Grade	Club	1	2	3	Vic.	Pts	Pos
1	CHAMPAGNE Daphnée (44,50)	4k	QC/Victo	XX					
2	VILLENEUVE Constance (44,1	4k+	QC/Albatros		XX				
3	PELLERIN Livia (39,40)	4k+	QC/Jonquiere			XX			

Matches

Match	Blanc			Bleu	Résultat	Temps	Code
A-15	CHAMPAGNE Daphnée	1	2	VILLENEUVE Constance			
A-29	CHAMPAGNE Daphnée	1	3	PELLERIN Livia			
A-41	VILLENEUVE Constance	2	3	PELLERIN Livia			

Résultats

Pos	Nom

U14F - 03

Compétiteurs

#	Nom	Grade	Club	1	2	3	Vic.	Pts	Pos
1	PELLERIN Charlie (46,10)	4k+	QC/Univestrie/Donini	XX					
2	SULLIVAN Blanche (45,70)	4k+	QC/Sakura (QC)		XX				
3	CROTEAU Maxime (52,10)	4k+	QC/Beauport			XX			

Matches

Match	Blanc			Bleu	Résultat	Temps	Code
C-12	PELLERIN Charlie	1	2	SULLIVAN Blanche			
C-28	PELLERIN Charlie	1	3	CROTEAU Maxime			
C-43	SULLIVAN Blanche	2	3	CROTEAU Maxime			

Résultats

Pos	Nom

U14F - 04

Compétiteurs

#	Nom	Grade	Club	1	2	3	Vic.	Pts	Pos
1	CHOUCHANE Fatma (39,40)	5k+	QC/Seiko	XX					
2	PARENT Julianne (35,10)	5k	QC/Albatros		XX				
3	GAGNÉ GAUTHIER Charlie (37	4k	QC/Beauport			XX			

Matches

Match	Blanc			Bleu	Résultat	Temps	Code
B-12	CHOUCHANE Fatma	1	2	PARENT Julianne			
B-27	CHOUCHANE Fatma	1	3	GAGNÉ GAUTHIER Charlie			
B-42	PARENT Julianne	2	3	GAGNÉ GAUTHIER Charlie			

Résultats

Pos	Nom

U14F - 05

Compétiteurs

#	Nom	Grade	Club	1	2	3	4	Vic.	Pts	Pos
1	GAGNÉ Shaélie (41,60)	5k	QC/Albatros	XX						
2	CYR-MARUYAMA Océane (42,60)	5k+	QC/CJVR		XX					
3	VALOIS Clothilde (42,50)	5k+	QC/Charlesbourg			XX				
4	BRASSARD Florence (43,60)	5k	QC/Chicoutimi				XX			

Matches

Match	Blanc			Bleu	Résultat	Temps	Code
B-10	GAGNÉ Shaélie	1	2	CYR-MARUYAMA Océane			
B-11	VALOIS Clothilde	3	4	BRASSARD Florence			
B-25	GAGNÉ Shaélie	1	3	VALOIS Clothilde			
B-26	CYR-MARUYAMA Océane	2	4	BRASSARD Florence			
B-40	GAGNÉ Shaélie	1	4	BRASSARD Florence			
B-41	CYR-MARUYAMA Océane	2	3	VALOIS Clothilde			

Résultats

Pos	Nom

U14F - 06

Compétiteurs

#	Nom	Grade	Club	1	2	1	2	1	2	Vic.	Pts	Pos
1	LATERREUR Jeanne (48,10)	4k	QC/La Pocatiere	XX		XX		XX				
2	BAKER Charlotte (53,50)	5k	QC/Beauport		XX		XX		XX			

Matches

Match	Blanc			Bleu	Résultat	Temps	Code
D-9	LATERREUR Jeanne	1	2	BAKER Charlotte			
D-22	BAKER Charlotte	2	1	LATERREUR Jeanne			
D-33	LATERREUR Jeanne	1	2	BAKER Charlotte			

Résultats

Pos	Nom

U14F -33kg 3k+

Compétiteurs

#	Nom	Grade	Club	1	2	1	2	1	2	Vic.	Pts	Pos
1	BOUBEKEUR Lina Sofia (32,6	3k	QC/Kiseki	XX		XX		XX				
2	MARCOUX Julia (31,90)	3k	QC/Judo Kai		XX		XX		XX			

Matches

Match	Blanc			Bleu	Résultat	Temps	Code
D-14	BOUBEKEUR Lina Sofia	1	2	MARCOUX Julia			
D-25	MARCOUX Julia	2	1	BOUBEKEUR Lina Sofia			
D-38	BOUBEKEUR Lina Sofia	1	2	MARCOUX Julia			

Résultats

Pos	Nom

U14F -36kg 3k+

Compétiteurs

#	Nom	Grade	Club	1	2	1	2	1	2	Vic.	Pts	Pos
1	BAER-DREYFUS Adele (33,80)	3k	QC/Magog	XX		XX		XX				
2	TREMBLAY Aimy (34,10)	2k	QC/Chicoutimi		XX		XX		XX			

Matches

Match	Blanc			Bleu	Résultat	Temps	Code
B-6	BAER-DREYFUS Adele	1	2	TREMBLAY Aimy			
B-21	TREMBLAY Aimy	2	1	BAER-DREYFUS Adele			
B-36	BAER-DREYFUS Adele	1	2	TREMBLAY Aimy			

Résultats

Pos	Nom

U14F -44kg 3k+

Compétiteurs

#	Nom	Grade	Club	1	2	3	4	Vic.	Pts	Pos
1	RODGERS Laurianne (42,50)	2k	QC/Sept-Iles	XX						
2	HINS Magalie (42,70)	3k+	QC/Judo Beauce		XX					
3	FORTIN Midorie Anne (43,30)	3k	QC/Universite Laval			XX				
4	RICHAUD Lili-Eve (43,60)	3k	QC/Beauport				XX			

Matches

Match	Blanc			Bleu	Résultat	Temps	Code
B-13	RODGERS Laurianne	1	2	HINS Magalie			
B-14	FORTIN Midorie Anne	3	4	RICHAUD Lili-Eve			
B-28	RODGERS Laurianne	1	3	FORTIN Midorie Anne			
B-29	HINS Magalie	2	4	RICHAUD Lili-Eve			
B-47	RODGERS Laurianne	1	4	RICHAUD Lili-Eve			
B-48	HINS Magalie	2	3	FORTIN Midorie Anne			

Résultats

Pos	Nom

U14F -48kg 3k+

Compétiteurs

#	Nom	Grade	Club	1	2	3	4	5	Vic.	Pts	Pos
1	PÉRUSSE Rose (46,80)	3k	QC/Beauport	XX							
2	DUBE Laurence (45,40)	2k	QC/Sept-Iles		XX						
3	SAVARD Tempérance (46,80)	3k	QC/Rikidokan (QC)			XX					
4	LEWIS Khloe (47,10)	3k	QC/Perrot Shima				XX				
5	DYKE Mia (47,40)	3k	QC/Zenshin					XX			

Matches

Match	Blanc			Bleu	Résultat	Temps	Code
D-1	LEWIS Khloe	4	5	DYKE Mia			
D-2	PÉRUSSE Rose	1	2	DUBE Laurence			
D-7	SAVARD Tempérance	3	4	LEWIS Khloe			
D-8	PÉRUSSE Rose	1	5	DYKE Mia			
D-18	DUBE Laurence	2	3	SAVARD Tempérance			
D-19	PÉRUSSE Rose	1	4	LEWIS Khloe			
D-29	SAVARD Tempérance	3	5	DYKE Mia			
D-30	DUBE Laurence	2	4	LEWIS Khloe			
D-42	PÉRUSSE Rose	1	3	SAVARD Tempérance			
D-43	DUBE Laurence	2	5	DYKE Mia			

Résultats

Pos	Nom

U14F -52kg 3k+

Compétiteurs

#	Nom	Grade	Club	1	2	3	4	Vic.	Pts	Pos
1	BROOMFIELD Ana (51,20)	3k	QC/Shidokan	XX						
2	LAVOIE Camille (49,10)	2k	QC/Jonquiere		XX					
3	OUDOVIKINE Ksenia (50,20)	3k	ON/Taifu			XX				
4	BOUCHER Mia (48,90)	3k	NB/Kimo				XX			

Matches

Match	Blanc			Bleu	Résultat	Temps	Code
A-13	BROOMFIELD Ana	1	2	LAVOIE Camille			
A-14	OUDOVIKINE Ksenia	3	4	BOUCHER Mia			
A-27	BROOMFIELD Ana	1	3	OUDOVIKINE Ksenia			
A-28	LAVOIE Camille	2	4	BOUCHER Mia			
A-39	BROOMFIELD Ana	1	4	BOUCHER Mia			
A-40	LAVOIE Camille	2	3	OUDOVIKINE Ksenia			

Résultats

Pos	Nom

U14F -57kg 3k+

Compétiteurs

#	Nom	Grade	Club	1	2	3	Vic.	Pts	Pos
1	GAGNE Magalie (55,70)	3k	QC/Albatros	XX					
2	SIMARD Megan (55,80)	3k	QC/Sakura (QC)		XX				
3	PROULX-OLSON Mckenna (56,2	3k	QC/Perrot Shima			XX			

Matches

Match	Blanc			Bleu	Résultat	Temps	Code
A-18	GAGNE Magalie	1	2	SIMARD Megan			
A-32	GAGNE Magalie	1	3	PROULX-OLSON Mckenna			
A-44	SIMARD Megan	2	3	PROULX-OLSON Mckenna			

Résultats

Pos	Nom

U14M - 01

Compétiteurs

#	Nom	Grade	Club	1	2	3	4	Vic.	Pts	Pos
1	VALLEE Raphael (31,50)	4k+	QC/Baie-Comeau	XX						
2	POULIN Olivier (31,40)	4k+	QC/Baie-Comeau		XX					
3	JUTEAU Charles (28,00)	4k+	QC/CJVR			XX				
4	TREMBLAY Philippe (31,50)	4k+	QC/Multikyo				XX			

Matches

Match	Blanc			Bleu	Résultat	Temps	Code
D-20	VALLEE Raphael	1	2	POULIN Olivier			
D-21	JUTEAU Charles	3	4	TREMBLAY Philippe			
D-31	VALLEE Raphael	1	3	JUTEAU Charles			
D-32	POULIN Olivier	2	4	TREMBLAY Philippe			
D-44	VALLEE Raphael	1	4	TREMBLAY Philippe			
D-45	POULIN Olivier	2	3	JUTEAU Charles			

Résultats

Pos	Nom

U14M - 02

Compétiteurs

#	Nom	Grade	Club	1	2	3	4	Vic.	Pts	Pos
1	BERNARD Simeon (32,00)	4k+	QC/Jonquiere	XX						
2	HARVEY Frédéric (32,60)	4k+	QC/Jonquiere		XX					
3	BENZERROUK Mohamed Idris (4k+	QC/Shidokan			XX				
4	DUPERRÉ Antoine (33,60)	4k+	QC/Haut-Richelieu				XX			

Matches

Match	Blanc			Bleu	Résultat	Temps	Code
D-10	BERNARD Simeon	1	2	HARVEY Frédéric			
D-11	BENZERROUK Mohamed Idris	3	4	DUPERRÉ Antoine			
D-23	BERNARD Simeon	1	3	BENZERROUK Mohamed Idris			
D-24	HARVEY Frédéric	2	4	DUPERRÉ Antoine			
D-34	BERNARD Simeon	1	4	DUPERRÉ Antoine			
D-35	HARVEY Frédéric	2	3	BENZERROUK Mohamed Idris			

Résultats

Pos	Nom

U14M - 03

Compétiteurs

#	Nom	Grade	Club	1	2	3	4	Vic.	Pts	Pos
1	DUCHESNE Bryan (34,90)	4k+	QC/Jonquiere	XX						
2	LABRECQUE Felix (33,70)	4k+	QC/Jonquiere		XX					
3	DUPONT Logan (35,30)	4k	QC/Baie-Comeau			XX				
4	BELLEGARDE Thomas (34,30)	4k+	QC/Levis				XX			

Matches

Match	Blanc			Bleu	Résultat	Temps	Code
B-7	DUCHESNE Bryan	1	2	LABRECQUE Felix			
B-8	DUPONT Logan	3	4	BELLEGARDE Thomas			
B-22	DUCHESNE Bryan	1	3	DUPONT Logan			
B-23	LABRECQUE Felix	2	4	BELLEGARDE Thomas			
B-37	DUCHESNE Bryan	1	4	BELLEGARDE Thomas			
B-38	LABRECQUE Felix	2	3	DUPONT Logan			

Résultats

Pos	Nom

U14M - 04

Compétiteurs

#	Nom	Grade	Club	1	2	3	4	Vic.	Pts	Pos
1	HARVEY Charly (35,90)	4k	QC/Albatros	XX						
2	METELLUS Malik-Richard (37	4k	QC/Kiseki		XX					
3	CORTEZ Nicolas (36,30)	4k+	QC/Blainville			XX				
4	TERRIEN Raphael (36,70)	4k+	QC/Shidokan				XX			

Matches

Match	Blanc			Bleu	Résultat	Temps	Code
D-15	HARVEY Charly	1	2	METELLUS Malik-Richard			
D-16	CORTEZ Nicolas	3	4	TERRIEN Raphael			
D-26	HARVEY Charly	1	3	CORTEZ Nicolas			
D-27	METELLUS Malik-Richard	2	4	TERRIEN Raphael			
D-39	HARVEY Charly	1	4	TERRIEN Raphael			
D-40	METELLUS Malik-Richard	2	3	CORTEZ Nicolas			

Résultats

Pos	Nom

U14M - 05

Compétiteurs

#	Nom	Grade	Club	1	2	3	4	Vic.	Pts	Pos
1	BLANCHETTE Maverick (40,40)	4k+	QC/Haut-Richelieu	XX						
2	LACASSE Étienne (40,50)	4k+	QC/Haut-Richelieu		XX					
3	BEAUCHAMP Payden (38,20)	4k	ON/Hawkesbury			XX				
4	CULCITCHI David (40,50)	4k+	QC/Ippon				XX			

Matches

Match	Blanc			Bleu	Résultat	Temps	Code
A-9	BLANCHETTE Maverick	1	2	LACASSE Étienne			
A-10	BEAUCHAMP Payden	3	4	CULCITCHI David			
A-21	BLANCHETTE Maverick	1	3	BEAUCHAMP Payden			
A-22	LACASSE Étienne	2	4	CULCITCHI David			
A-35	BLANCHETTE Maverick	1	4	CULCITCHI David			
A-36	LACASSE Étienne	2	3	BEAUCHAMP Payden			

Résultats

Pos	Nom

U14M - 06

Compétiteurs

#	Nom	Grade	Club	1	2	3	4	Vic.	Pts	Pos
1	TREMBLAY Samuel (41,30)	4k+	QC/Chicoutimi	XX						
2	JOLY Charles-Antoine (42,3)	4k+	QC/Chicoutimi		XX					
3	DIONNE Clovis (42,90)	4k	QC/La Pocatiere			XX				
4	LÉVESQUE Thomas (41,10)	4k	QC/Sept-Iles				XX			

Matches

Match	Blanc			Bleu	Résultat	Temps	Code
A-16	TREMBLAY Samuel	1	2	JOLY Charles-Antoine			
A-17	DIONNE Clovis	3	4	LÉVESQUE Thomas			
A-30	TREMBLAY Samuel	1	3	DIONNE Clovis			
A-31	JOLY Charles-Antoine	2	4	LÉVESQUE Thomas			
A-42	TREMBLAY Samuel	1	4	LÉVESQUE Thomas			
A-43	JOLY Charles-Antoine	2	3	DIONNE Clovis			

Résultats

Pos	Nom

U14M - 07

Compétiteurs

#	Nom	Grade	Club	1	2	3	Vic.	Pts	Pos
1	BONILLA RODRIGUEZ Marvin (4k+	QC/Olympique	XX					
2	GAGNÉ Élie (45,70)	4k	QC/Seiko		XX				
3	BOISVERT Florian (44,60)	4k	QC/Beauport			XX			

Matches

Match	Blanc			Bleu	Résultat	Temps	Code
C-8	BONILLA RODRIGUEZ Marvin	1	2	GAGNÉ Élie			
C-24	BONILLA RODRIGUEZ Marvin	1	3	BOISVERT Florian			
C-48	GAGNÉ Élie	2	3	BOISVERT Florian			

Résultats

Pos	Nom

U14M - 08

Compétiteurs

#	Nom	Grade	Club	1	2	3	4	Vic.	Pts	Pos
1	CARRILLO Roger Abraham (53	5k	QC/Kiseki	XX						
2	BADAOUI Lyes-Adam (56,60)	4k+	QC/Torii		XX					
3	VERMOREL CANONGE Hugo (52,	4k	QC/Universite Laval			XX				
4	BRIERE Raphael (50,10)	4k	QC/Multisports				XX			

Matches

Match	Blanc			Bleu	Résultat	Temps	Code
C-4	CARRILLO Roger Abraham	1	2	BADAOUI Lyes-Adam			
C-5	VERMOREL CANONGE Hugo	3	4	BRIERE Raphael			
C-20	CARRILLO Roger Abraham	1	3	VERMOREL CANONGE Hugo			
C-21	BADAOUI Lyes-Adam	2	4	BRIERE Raphael			
C-36	CARRILLO Roger Abraham	1	4	BRIERE Raphael			
C-37	BADAOUI Lyes-Adam	2	3	VERMOREL CANONGE Hugo			

Résultats

Pos	Nom

U14M - 09

Compétiteurs

#	Nom	Grade	Club	1	2	3	Vic.	Pts	Pos
1	MARCOUX Christophe (71,30)	4k	QC/Haut-Richelieu	XX					
2	KOWALCZYK Marek (62,20)	4k+	QC/CJVR		XX				
3	TROTIER Vincent (66,10)	4k+	QC/Baie-Comeau			XX			

Matches

Match	Blanc			Bleu	Résultat	Temps	Code
C-15	MARCOUX Christophe	1	2	KOWALCZYK Marek			
C-31	MARCOUX Christophe	1	3	TROTIER Vincent			
C-49	KOWALCZYK Marek	2	3	TROTIER Vincent			

Résultats

Pos	Nom

U14M - 10

Compétiteurs

#	Nom	Grade	Club	1	2	3	4	Vic.	Pts	Pos
1	RODRIGUE Raphaël (30,20)	5k+	QC/Judo Beauce	XX						
2	SIMARD Éliot (29,80)	5k+	QC/Seiko		XX					
3	MAYER-MEAS Sovann (31,00)	5k	QC/Zenshin			XX				
4	MARCEAU Alexis (31,10)	5k	QC/Albatros				XX			

Matches

Match	Blanc			Bleu	Résultat	Temps	Code
A-19	RODRIGUE Raphaël	1	2	SIMARD Éliot			
A-20	MAYER-MEAS Sovann	3	4	MARCEAU Alexis			
A-33	RODRIGUE Raphaël	1	3	MAYER-MEAS Sovann			
A-34	SIMARD Éliot	2	4	MARCEAU Alexis			
A-45	RODRIGUE Raphaël	1	4	MARCEAU Alexis			
A-46	SIMARD Éliot	2	3	MAYER-MEAS Sovann			

Résultats

Pos	Nom

U14M - 11

Compétiteurs

#	Nom	Grade	Club	1	2	3	4	Vic.	Pts	Pos
1	SHEPELIEV Yehor (35,40)	5k+	QC/Ippon	XX						
2	LYNA Jordan (37,40)	5k	QC/Albatros		XX					
3	PRIVÉ-BOUCHARD Maël (36,20)	5k+	QC/Seiko			XX				
4	BÉRUBÉ VILLENEUVE Brandon	5k	QC/Ju Shin Kan				XX			

Matches

Match	Blanc			Bleu	Résultat	Temps	Code
C-6	SHEPELIEV Yehor	1	2	LYNA Jordan			
C-7	PRIVÉ-BOUCHARD Maël	3	4	BÉRUBÉ VILLENEUVE Brandon			
C-22	SHEPELIEV Yehor	1	3	PRIVÉ-BOUCHARD Maël			
C-23	LYNA Jordan	2	4	BÉRUBÉ VILLENEUVE Brandon			
C-38	SHEPELIEV Yehor	1	4	BÉRUBÉ VILLENEUVE Brandon			
C-39	LYNA Jordan	2	3	PRIVÉ-BOUCHARD Maël			

Résultats

Pos	Nom

U14M - 12

Compétiteurs

#	Nom	Grade	Club	1	2	3	4	Vic.	Pts	Pos
1	MIGNAULT Antoine (42,30)	5k	QC/Kiseki	XX						
2	ST-GELAIS Mathieu (44,10)	5k	QC/Baie-Comeau		XX					
3	MALTAIS Noah (45,80)	5k	NB/Restigouche			XX				
4	PICCIONE Gabriel (40,20)	5k	QC/Ju Shin Kan				XX			

Matches

Match	Blanc			Bleu	Résultat	Temps	Code
C-16	MIGNAULT Antoine	1	2	ST-GELAIS Mathieu			
C-17	MALTAIS Noah	3	4	PICCIONE Gabriel			
C-32	MIGNAULT Antoine	1	3	MALTAIS Noah			
C-33	ST-GELAIS Mathieu	2	4	PICCIONE Gabriel			
C-50	MIGNAULT Antoine	1	4	PICCIONE Gabriel			
C-50A	ST-GELAIS Mathieu	2	3	MALTAIS Noah			

Résultats

Pos	Nom

U14M - 13

Compétiteurs

#	Nom	Grade	Club	1	2	3	4	Vic.	Pts	Pos
1	SALAH Riad (54,20)	5k	QC/Levis	XX						
2	MADANI Racim (47,10)	5k	QC/Torii		XX					
3	GILBERT DORE Victor (52,50)	5k	QC/Ju Shin Kan			XX				
4	DELISLE Malik (47,50)	5k	QC/Seiko				XX			

Matches

Match	Blanc			Bleu	Résultat	Temps	Code
C-13	SALAH Riad	1	2	MADANI Racim			
C-14	GILBERT DORE Victor	3	4	DELISLE Malik			
C-29	SALAH Riad	1	3	GILBERT DORE Victor			
C-30	MADANI Racim	2	4	DELISLE Malik			
C-44	SALAH Riad	1	4	DELISLE Malik			
C-45	MADANI Racim	2	3	GILBERT DORE Victor			

Résultats

Pos	Nom

U14M -32kg 3k+

Compétiteurs

#	Nom	Grade	Club	1	2	1	2	1	2	Vic.	Pts	Pos
1	GAUTHIER Simon (31,80)	2k	QC/Jonquiere	XX		XX		XX				
2	BENKHEDOUMA Mohamed (28,80)	3k	QC/St. Leonard		XX		XX		XX			

Matches

Match	Blanc			Bleu	Résultat	Temps	Code
B-9	GAUTHIER Simon	1	2	BENKHEDOUMA Mohamed			
B-24	BENKHEDOUMA Mohamed	2	1	GAUTHIER Simon			
B-39	GAUTHIER Simon	1	2	BENKHEDOUMA Mohamed			

Résultats

Pos	Nom

U14M -35kg 3k+

Compétiteurs A

#	Nom	Grade	Club	1	2	3	4	Vic.	Pts	Pos
1	AVSKER Ashton (34,50)	3k	QC/Shidokan	XX						
2	BERNATCHEZ Manny (34,20)	2k	QC/Sept-Iles		XX					
3	PAQUET Samuel (34,80)	3k	QC/Metropolitain			XX				
4	SÉGUIN Noah (34,80)	3k+	QC/CJVR				XX			

Pool A

Match	Blanc			Bleu	Résultat	Temps	Code
B-3	AVSKER Ashton	1	2	BERNATCHEZ Manny			
B-4	PAQUET Samuel	3	4	SÉGUIN Noah			
B-18	AVSKER Ashton	1	3	PAQUET Samuel			
B-19	BERNATCHEZ Manny	2	4	SÉGUIN Noah			
B-33	AVSKER Ashton	1	4	SÉGUIN Noah			
B-34	BERNATCHEZ Manny	2	3	PAQUET Samuel			

Compétiteurs B

#	Nom	Grade	Club	5	6	7	Vic.	Pts	Pos
5	BEAUREGARD Liam (33,70)	3k+	QC/CJVR	XX					
6	SCORTEANU Victor (34,00)	3k	QC/Shidokan		XX				
7	TURGEON Jayden (33,60)	3k	QC/Lachenaie			XX			

Pool B

Match	Blanc			Bleu	Résultat	Temps	Code
B-5	BEAUREGARD Liam	5	6	SCORTEANU Victor			
B-20	BEAUREGARD Liam	5	7	TURGEON Jayden			
B-35	SCORTEANU Victor	6	7	TURGEON Jayden			

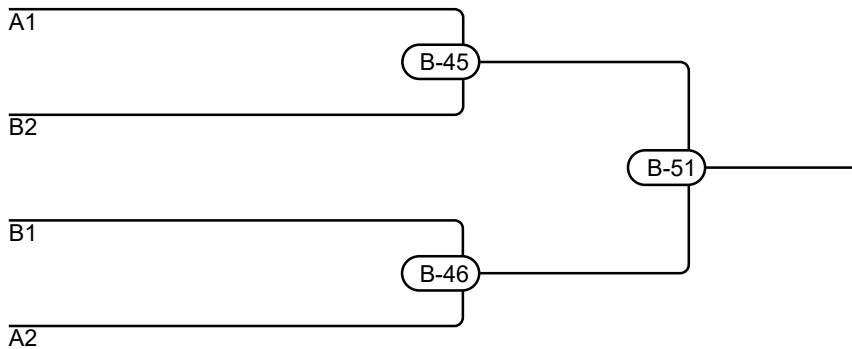

Résultats

Pos	Nom
1	
2	
3	
3	

U14M -38kg 3k+

Compétiteurs A

#	Nom	Grade	Club	1	2	3	4	Vic.	Pts	Pos
1	GAUTHIER Victor (35,40)	3k	QC/Seikidokan (QC)	XX						
2	LAPOINTE Alexis (38,10)	3k	QC/CJVR		XX					
3	PETROCHENKOV Tikhon (36,30)	3k	ON/Taifu			XX				
4	TSYDINSKY Artem (36,10)	3k	NB/Otoshi				XX			

Pool A

Match	Blanc			Bleu	Résultat	Temps	Code
C-9	GAUTHIER Victor	1	2	LAPOINTE Alexis			
C-10	PETROCHENKOV Tikhon	3	4	TSYDINSKY Artem			
C-25	GAUTHIER Victor	1	3	PETROCHENKOV Tikhon			
C-26	LAPOINTE Alexis	2	4	TSYDINSKY Artem			
C-40	GAUTHIER Victor	1	4	TSYDINSKY Artem			
C-41	LAPOINTE Alexis	2	3	PETROCHENKOV Tikhon			

Compétiteurs B

#	Nom	Grade	Club	5	6	7	Vic.	Pts	Pos
5	BRODEUR Benjamin (36,70)	3k	QC/Boucherville	XX					
6	ROY VANASSE Tyson (37,60)	3k	QC/Haut-Richelieu		XX				
7	RESHETNIKOV Prokhor (37,10)	3k	ON/Taifu			XX			

Pool B

Match	Blanc			Bleu	Résultat	Temps	Code
C-11	BRODEUR Benjamin	5	6	ROY VANASSE Tyson			
C-27	BRODEUR Benjamin	5	7	RESHETNIKOV Prokhor			
C-42	ROY VANASSE Tyson	6	7	RESHETNIKOV Prokhor			

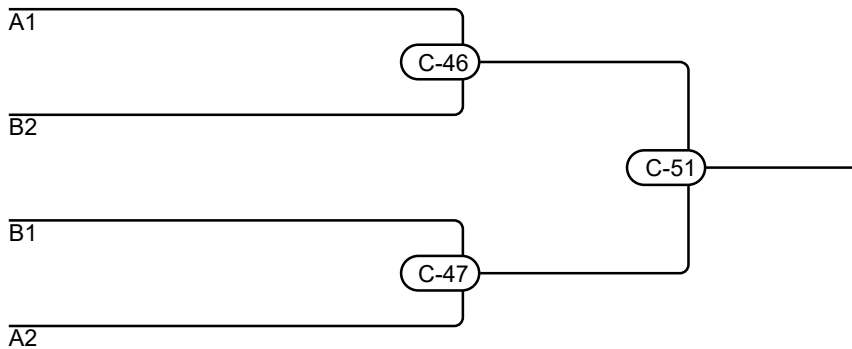

Résultats

Pos	Nom
1	
2	
3	
3	

U14M -42kg 3k+

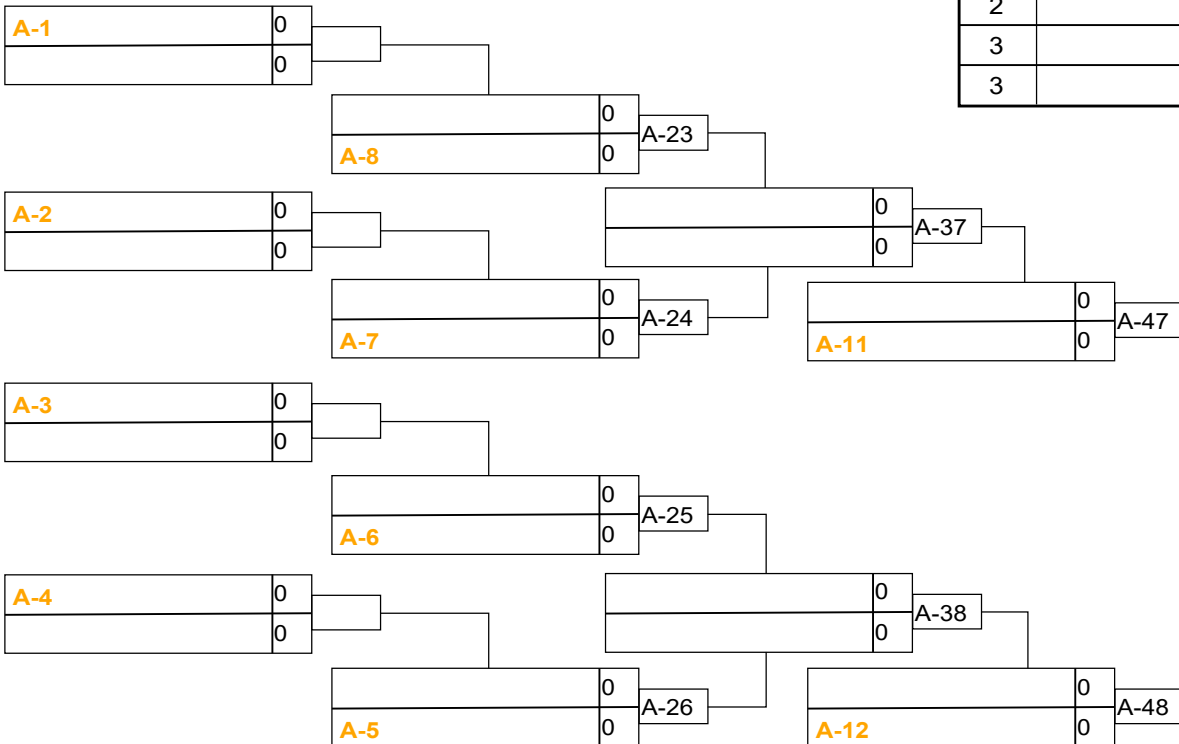
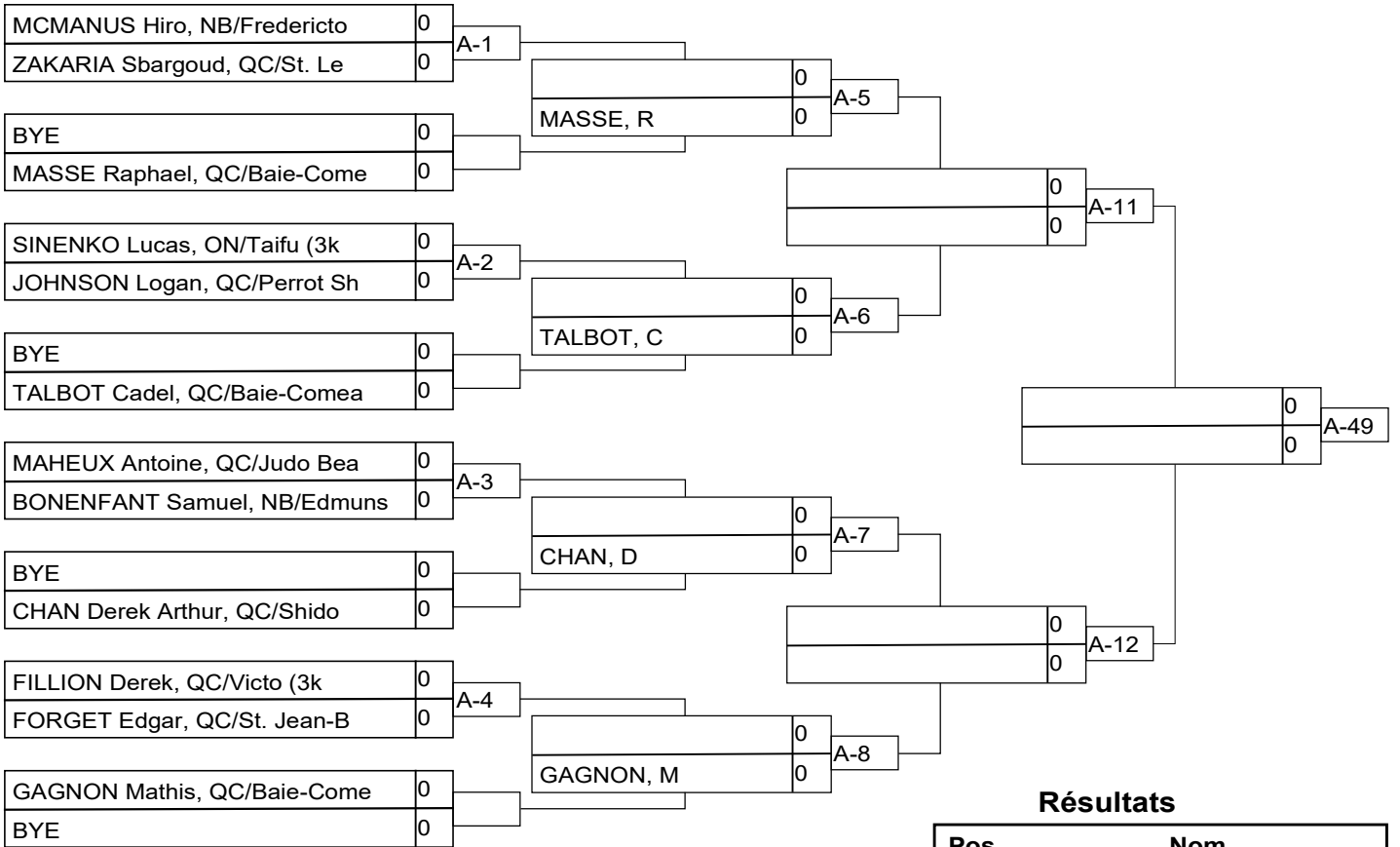

U14M -46kg 3k+

Compétiteurs A

#	Nom	Grade	Club	1	2	3	Vic.	Pts	Pos
1	LEFORT Théodore (44,30)	2k	QC/St. Hubert	XX					
2	MIRON Alexi (45,10)	3k+	QC/Seikidokan (QC)		XX				
3	DUGUAY Medric (44,10)	2k	QC/Sept-Iles			XX			

Pool A

Match	Blanc			Bleu	Résultat	Temps	Code
B-1	LEFORT Théodore	1	2	MIRON Alexi			
B-16	LEFORT Théodore	1	3	DUGUAY Medric			
B-31	MIRON Alexi	2	3	DUGUAY Medric			

Compétiteurs B

#	Nom	Grade	Club	4	5	6	Vic.	Pts	Pos
4	BOUTERFA Aylan (45,10)	3k	QC/Blainville	XX					
5	ASSELIN Jayden (42,80)	3k	QC/Albatros		XX				
6	FORTIN Tristan (42,30)	2k	QC/Port-Cartier			XX			

Pool B

Match	Blanc			Bleu	Résultat	Temps	Code
B-2	BOUTERFA Aylan	4	5	ASSELIN Jayden			
B-17	BOUTERFA Aylan	4	6	FORTIN Tristan			
B-32	ASSELIN Jayden	5	6	FORTIN Tristan			

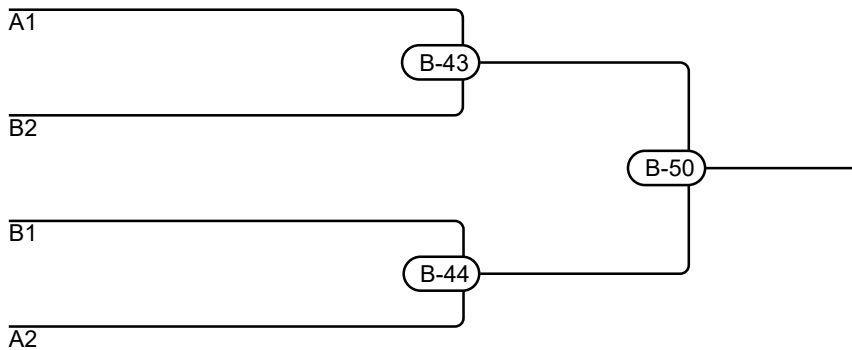

Résultats

Pos	Nom
1	
2	
3	
3	

U14M -50kg 3k+

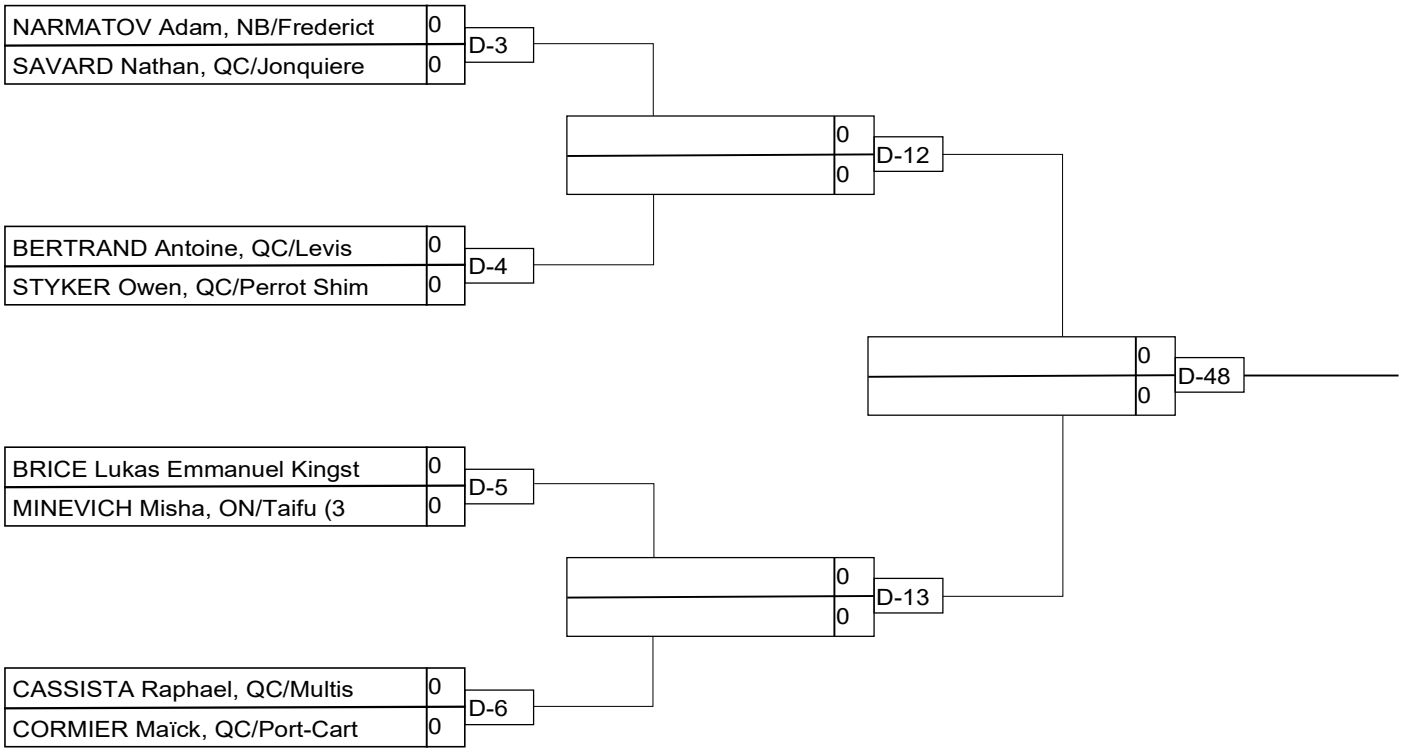

Résultats

Pos	Nom
1	
2	
3	
3	

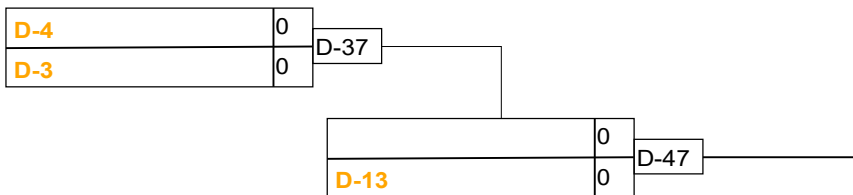
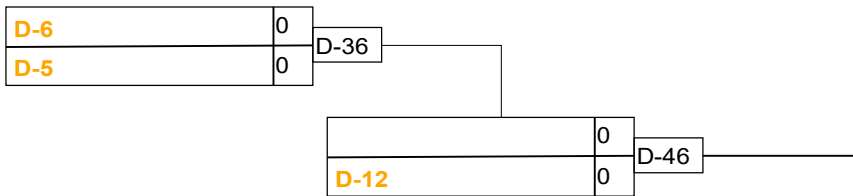

U14M -55kg 3k+

Compétiteurs

#	Nom	Grade	Club	1	2	1	2	1	2	Vic.	Pts	Pos
1	HADDOUCHE Ahmed (54,80)	3k	QC/St. Leonard	XX		XX		XX				
2	GRENIER Emerick (53,50)	3k	QC/Zenshin		XX		XX		XX			

Matches

Match	Blanc			Bleu	Résultat	Temps	Code
B-15	HADDOUCHE Ahmed	1	2	GRENIER Emerick			
B-30	GRENIER Emerick	2	1	HADDOUCHE Ahmed			
B-49	HADDOUCHE Ahmed	1	2	GRENIER Emerick			

Résultats

Pos	Nom

U14M -66kg 3k+

Compétiteurs

#	Nom	Grade	Club	1	2	3	4	Vic.	Pts	Pos
1	AZAR Ibrahim (60,20)	3k+	QC/Shidokan	XX						
2	GUISEN Mathias (59,40)	3k+	QC/Shidokan		XX					
3	VILLENEUVE Maxim (58,30)	3k	QC/Zenshin			XX				
4	PETRO David (62,70)	3k	QC/Perrot Shima				XX			

Matches

Match	Blanc			Bleu	Résultat	Temps	Code
C-1	AZAR Ibrahim	1	2	GUISEN Mathias			
C-2	VILLENEUVE Maxim	3	4	PETRO David			
C-18	AZAR Ibrahim	1	3	VILLENEUVE Maxim			
C-19	GUISEN Mathias	2	4	PETRO David			
C-34	AZAR Ibrahim	1	4	PETRO David			
C-35	GUISEN Mathias	2	3	VILLENEUVE Maxim			

Résultats

Pos	Nom