

# U21SENF -01

## Compétiteurs

#	Nom	Grade	Club	1	2	1	2	1	2	Vic.	Pts	Pos
1	GAGNE Moira (62,00)	3k	QC/Albatros	XX	10	XX	10	XX		2	20	1
2	LAVOIE Saskia (66,10)	3k	QC/Université Laval		XX		XX		XX	0	0	2

## Matches

Match	Blanc			Bleu	Résultat	Temps	Code
D-29	<b>GAGNE Moira</b>	1	2	LAVOIE Saskia	10 - 0	0:50	WIP
D-41	LAVOIE Saskia	2	1	<b>GAGNE Moira</b>	0 - 10	2:07	IPO
D-53	GAGNE Moira	1	2	LAVOIE Saskia			

## Résultats

Pos	Nom
1	GAGNE Moira, QC/Albatros

# U21SENF -03

## Compétiteurs

#	Nom	Grade	Club	1	2	1	2	1	2	Vic.	Pts	Pos
1	ALVES Esther (49,70)	4k	QC/Olympique	XX		XX		XX		0	0	2
2	AMMARI Yasmine (55,00)	4k+	QC/CJCSHP	10	XX	10	XX		XX	2	20	1

## Matches

Match	Blanc			Bleu	Résultat	Temps	Code
A-29	ALVES Esther	1	2	AMMARI Yasmine	0 - 10	0:22	IPO
A-38	AMMARI Yasmine	2	1	ALVES Esther	10 - 0	3:04	IPO
A-49	ALVES Esther	1	2	AMMARI Yasmine			

## Résultats

Pos	Nom
1	AMMARI Yasmine, QC/CJCSHP

# U21SENF -04

## Compétiteurs

#	Nom	Grade	Club	1	2	1	2	1	2	Vic.	Pts	Pos
1	JACQUES Théodine (73,10)	3k	QC/St. Leonard	XX	10	XX	10	XX		2	20	1
2	NGANKO GABETH Adora Willia	4k	QC/Metropolitain		XX		XX		XX	0	0	2

## Matches

Match	Blanc			Bleu	Résultat	Temps	Code
B-43	JACQUES Théodine	1	2	NGANKO GABETH Adora Williamson	10 - 0	0:28	IPO
B-53	NGANKO GABETH Adora Williamson	2	1	JACQUES Théodine	0 - 10	0:52	WIP
B-61	JACQUES Théodine	1	2	NGANKO GABETH Adora Williamson			

## Résultats

Pos	Nom
1	JACQUES Théodine, QC/St. Leonard

# U21SENF -05

## Compétiteurs

#	Nom	Grade	Club	1	2	1	2	1	2	Vic.	Pts	Pos
1	TERRIEN Daphney (77,60)	2k	QC/CMR Saint-Jean	XX		XX		XX		0	0	2
2	JACQUES Théodine (73,10)	3k	QC/St. Leonard	10	XX	10	XX		XX	2	20	1

## Matches

Match	Blanc			Bleu	Résultat	Temps	Code
B-18	TERRIEN Daphney	1	2	JACQUES Théodine	0 - 10	0:12	IPO
B-28	JACQUES Théodine	2	1	TERRIEN Daphney	10 - 0	1:04	IPO
B-37	TERRIEN Daphney	1	2	JACQUES Théodine			

## Résultats

Pos	Nom
1	JACQUES Théodine, QC/St. Leonard

# U21SENF -48kg 2k+

## Compétiteurs

#	Nom	Grade	Club	1	2	1	2	1	2	Vic.	Pts	Pos
1	DELYE Maria-Magdaleina (43)	2k	QC/Shidokan	XX	10	XX	5	XX		2	15	1
2	GAGNE Emilie (46,40)	2k	QC/Albatros		XX		XX		XX	0	0	2

## Matches

Match	Blanc			Bleu	Résultat	Temps	Code
B-42	DELYE Maria-Magdaleina	1	2	GAGNE Emilie	10 - 0	0:13	IPO
B-52	GAGNE Emilie	2	1	DELYE Maria-Magdaleina	0 - 5	4:00	WAZ
B-60	DELYE Maria-Magdaleina	1	2	GAGNE Emilie			

## Résultats

Pos	Nom
1	DELYE Maria-Magdaleina, QC/Shidokan

# U21SENF -52kg 2k+

## Compétiteurs

#	Nom	Grade	Club	1	2	1	2	1	2	Vic.	Pts	Pos
1	NAIT SAID Yasmine (51,10)	2k	QC/St. Leonard	XX		XX	10	XX	5	2	15	1
2	MCCRISTALL Angelina (48,90)	1D	ON/Upper Canada	10	XX		XX		XX	1	10	2

## Matches

Match	Blanc			Bleu	Résultat	Temps	Code
A-37	NAIT SAID Yasmine	1	2	MCCRISTALL Angelina	0 - 10	0:49	IPO
A-48	MCCRISTALL Angelina	2	1	NAIT SAID Yasmine	0 - 10	0:47	IPO
A-57	NAIT SAID Yasmine	1	2	MCCRISTALL Angelina	5 - 0	4:30	GSW

## Résultats

Pos	Nom
1	NAIT SAID Yasmine, QC/St. Leonard
2	MCCRISTALL Angelina, ON/Upper Canada

# U21SENF -57kg 2k+

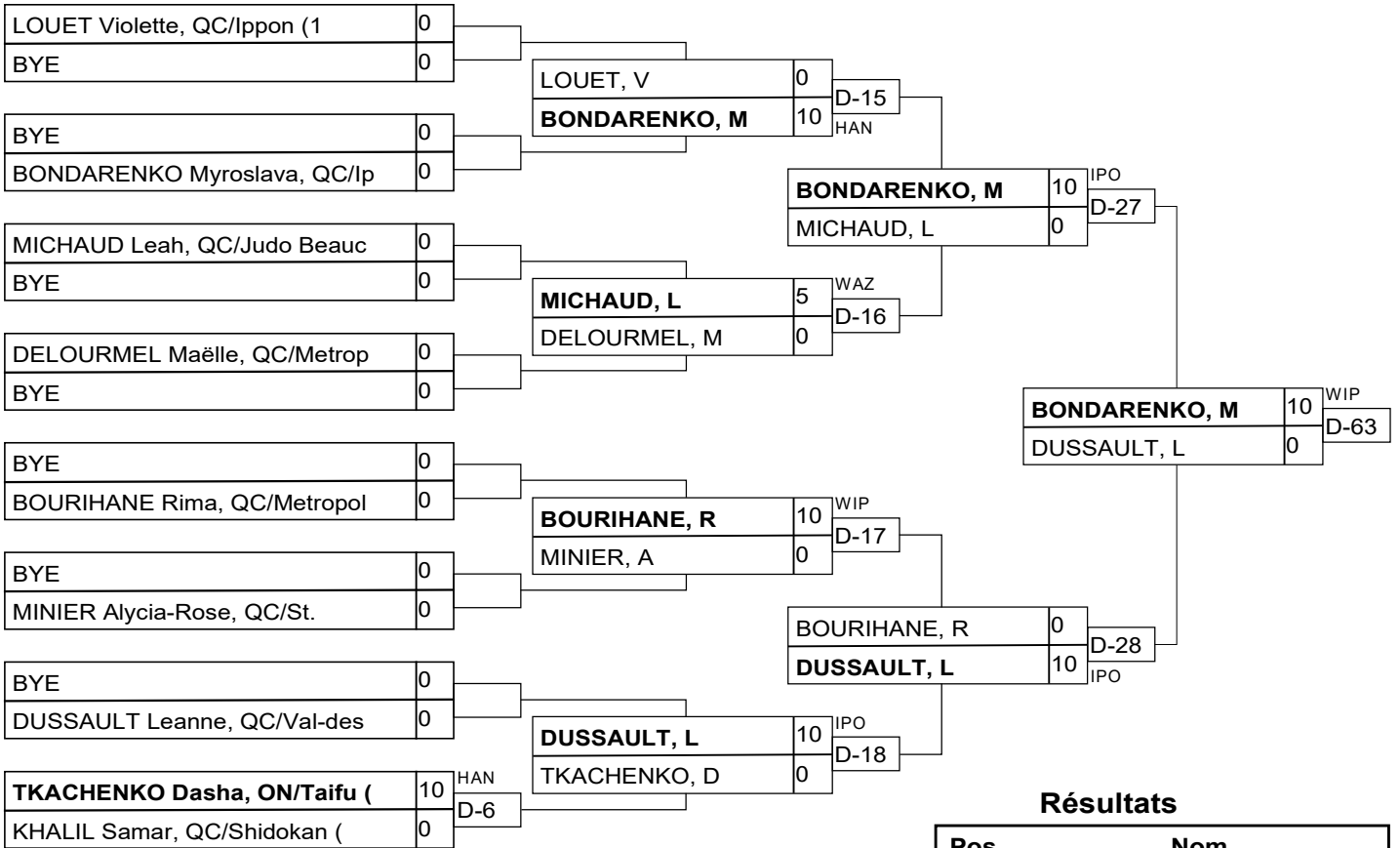

## Résultats

Pos	Nom
1	BONDARENKO Myroslava, QC
2	DUSSAULT Leanne, QC/Val-
3	TKACHENKO Dasha, ON/Taif
3	LOUET Violette, QC/Ippon

# U21SENF -63kg 2k+

## Compétiteurs A

#	Nom	Grade	Club	1	2	3	Vic.	Pts	Pos
1	TKACHENKO Alyssa (61,50)	1k	ON/Taifu	XX	10	10	2	20	1
2	GAULIN Katherine (61,80)	1k	QC/Juvaldo		XX		0	0	3
3	COUTURE Métis (62,80)	1D	QC/Judo Beauce		10	XX	1	10	2

## Pool A

Match	Blanc	Bleu	Résultat	Temps	Code
A-32	TKACHENKO Alyssa	1 2 GAULIN Katherine	10 - 0	1:02	IPO
A-43	TKACHENKO Alyssa	1 3 COUTURE Métis	10 - 0	0:56	WIP
A-52	GAULIN Katherine	2 3 COUTURE Métis	0 - 10	0:55	IPO

## Compétiteurs B

#	Nom	Grade	Club	4	5	6	Vic.	Pts	Pos
4	NGOMBI Miguela (62,70)	1k	QC/Shidokan	XX			0	0	3
5	MEZAOUR Camelia (62,60)	1D	QC/St. Leonard	10	XX	10	2	20	1
6	LANOUILLETTE Lea (60,40)	2k	QC/Blainville	10		XX	1	10	2

## Pool B

Match	Blanc	Bleu	Résultat	Temps	Code
A-33	NGOMBI Miguela	4 5 MEZAOUR Camelia	0 - 10	2:14	IPO
A-44	NGOMBI Miguela	4 6 LANOUILLETTE Lea	0 - 10	1:13	WIP
A-53	MEZAOUR Camelia	5 6 LANOUILLETTE Lea	10 - 0	0:55	IPO

### TKACHENKO

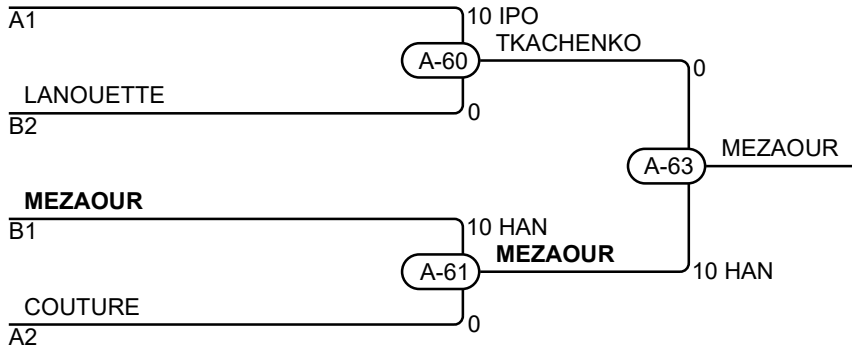

## Résultats

Pos	Nom
1	MEZAOUR Camelia, QC/St. Leonard
2	TKACHENKO Alyssa, ON/Taifu
3	LANOUILLETTE Lea, QC/Blainville
3	COUTURE Métis, QC/Judo Beauce



# U21SENF -70kg 2k+

## Compétiteurs

#	Nom	Grade	Club	1	2	3	Vic.	Pts	Pos
1	DORVAL-MBELE Missy Jen (69)	1k	QC/Metropolitain	XX	10	10	2	20	1
2	LAMRI Ralia (68,60)	1k	QC/Shidokan		XX		0	0	3
3	MALIN Chloé (68,60)	1D	NT/Yellowknife		10	XX	1	10	2

## Matches

Match	Blanc			Bleu	Résultat	Temps	Code
A-34	DORVAL-MBELE Missy Jen	1	2	LAMRI Ralia	10 - 0	0:14	IPO
A-45	DORVAL-MBELE Missy Jen	1	3	MALIN Chloé	10 - 0	0:46	IPO
A-54	LAMRI Ralia	2	3	MALIN Chloé	0 - 10	0:00	FUS

## Résultats

Pos	Nom
1	DORVAL-MBELE Missy Jen, QC/Metropolitain
2	MALIN Chloé, NT/Yellowknife

# U21SENM - 10

## Compétiteurs

#	Nom	Grade	Club	1	2	3	4	Vic.	Pts	Pos
1	GAGNE Edouard (88,50)	4k	QC/CMR Saint-Jean	XX	10	10	10	3	30	1
2	TCHAMENI MOKO Christian (8)	5k	QC/CMR Saint-Jean		XX	10		1	10	3
3	SAVARD Samy (86,90)	4k	QC/Olympique			XX		0	0	4
4	ETZITIAN Raphaël (88,80)	5k	QC/CMR Saint-Jean		10	10	XX	2	20	2

## Matches

Match	Blanc			Bleu	Résultat	Temps	Code
C-35	<b>GAGNE Edouard</b>	1	2	TCHAMENI MOKO Christian	10 - 0	0:18	IPO
C-36	SAVARD Samy	3	4	<b>ETZITIAN Raphaël</b>	0 - 10	0:14	IPO
C-47	<b>GAGNE Edouard</b>	1	3	SAVARD Samy	10 - 0	0:18	IPO
C-48	TCHAMENI MOKO Christian	2	4	<b>ETZITIAN Raphaël</b>	0 - 10	1:23	IPO
C-57	<b>GAGNE Edouard</b>	1	4	ETZITIAN Raphaël	10 - 0	1:43	IPO
C-58	<b>TCHAMENI MOKO Christian</b>	2	3	SAVARD Samy	10 - 0	1:02	IPO

## Résultats

Pos	Nom
1	GAGNE Edouard, QC/CMR Saint-Jean
2	ETZITIAN Raphaël, QC/CMR Saint-Jean
3	TCHAMENI MOKO Christian, QC/CMR Saint-Jean

# U21SENM - 11

## Compétiteurs

#	Nom	Grade	Club	1	2	3	4	Vic.	Pts	Pos
1	DODIER Alexis (94,10)	5k	QC/Univestrie/Donini	XX		10		1	10	3
2	DERKAOUI Ayman-Naïm (89,90)	5k	QC/Kiseki	10	XX	10		2	20	2
3	BIGNELL Benjamin (92,40)	5k	QC/Bushidokan			XX		0	0	4
4	DJENADI Rayan (91,20)	5k	QC/CJCSHP	10	10	10	XX	3	30	1

## Matches

Match	Blanc			Bleu	Résultat	Temps	Code
D-25	DODIER Alexis	1	2	DERKAOUI Ayman-Naïm	0 - 10	1:31	WIP
D-26	BIGNELL Benjamin	3	4	DJENADI Rayan	0 - 10	0:47	WIP
D-38	<b>DODIER Alexis</b>	1	3	BIGNELL Benjamin	10 - 0	2:10	IPO
D-39	DERKAOUI Ayman-Naïm	2	4	<b>DJENADI Rayan</b>	0 - 10	2:02	WIP
D-49	DODIER Alexis	1	4	<b>DJENADI Rayan</b>	0 - 10	1:39	IPO
D-50	<b>DERKAOUI Ayman-Naïm</b>	2	3	BIGNELL Benjamin	10 - 0	0:00	FUS

## Résultats

Pos	Nom
1	DJENADI Rayan, QC/CJCSHP
2	DERKAOUI Ayman-Naïm, QC/Kiseki
3	DODIER Alexis, QC/Univestrie/Donini

# U21SENM - 12

## Compétiteurs

#	Nom	Grade	Club	1	2	3	Vic.	Pts	Pos
1	MEHENNI Zakariya (111,70)	5k	QC/Bushidokan	XX		10	1	10	2
2	BABAI Dariush (102,80)	4k+	QC/Budokai (QC)	10	XX	10	2	20	1
3	DIMITRACOPOULOS Panayiotis	5k	Metropolitain			XX	0	0	3

## Matches

Match	Blanc			Bleu	Résultat	Temps	Code
D-22	MEHENNI Zakariya	1	2	BABAI Dariush	0 - 10	0:23	IPO
D-36	MEHENNI Zakariya	1	3	DIMITRACOPOULOS Panayiotis	10 - 0	1:12	WIP
D-46	BABAI Dariush	2	3	DIMITRACOPOULOS Panayiotis	10 - 0	0:50	IPO

## Résultats

Pos	Nom
1	BABAI Dariush, QC/Budokai (QC)
2	MEHENNI Zakariya, QC/Bushidokan

# U21SENM -01

## Compétiteurs

#	Nom	Grade	Club	1	2	3	Vic.	Pts	Pos
1	SAIDI Kahled (55,60)	3k	QC/St. Paul-l'Ermite	XX	10	10	2	20	1
2	VO David (51,30)	3k	QC/Jikan		XX	10	1	10	2
3	ROUSSEL-CONTRERAS Isarael	5k	QC/CMR Saint-Jean			XX	0	0	3

## Matches

Match	Blanc			Bleu	Résultat	Temps	Code
D-30	SAIDI Kahled	1	2	VO David	10 - 0	4:00	WIP
D-42	SAIDI Kahled	1	3	ROUSSEL-CONTRERAS Isarael	10 - 0	1:11	WIP
D-54	VO David	2	3	ROUSSEL-CONTRERAS Isarael	10 - 0	0:15	IPO

## Résultats

Pos	Nom
1	SAIDI Kahled, QC/St. Paul-l'Ermite
2	VO David, QC/Jikan

# U21SENM -02

## Compétiteurs

#	Nom	Grade	Club	1	2	3	4	Vic.	Pts	Pos
1	BEAUDOIN Nicolas (65,80)	3k	QC/Univestrie/Donini	XX			10	1	10	3
2	FORTIN Paul-Emeric (65,30)	3k	QC/Université Laval	10	XX		10	2	20	2
3	DEPANI Mario (65,60)	3k	QC/Torii	10	10	XX	10	3	30	1
4	BOUTERFA Madjid (60,70)	3k	QC/Blainville				XX	0	0	4

## Matches

Match	Blanc			Bleu	Résultat	Temps	Code
C-32	BEAUDOIN Nicolas	1	2	FORTIN Paul-Emeric	0 - 10	2:31	HAN
C-33	DEPANI Mario	3	4	BOUTERFA Madjid	10 - 0	2:12	IPO
C-44	BEAUDOIN Nicolas	1	3	DEPANI Mario	0 - 10	1:40	WIP
C-45	FORTIN Paul-Emeric	2	4	BOUTERFA Madjid	10 - 0	0:50	IPO
C-54	BEAUDOIN Nicolas	1	4	BOUTERFA Madjid	10 - 0	0:21	IPO
C-55	FORTIN Paul-Emeric	2	3	DEPANI Mario	0 - 10	1:53	IPO

## Résultats

Pos	Nom
1	DEPANI Mario, QC/Torii
2	FORTIN Paul-Emeric, QC/Université Laval
3	BEAUDOIN Nicolas, QC/Univestrie/Donini

# U21SENM -03

## Compétiteurs

#	Nom	Grade	Club	1	2	3	Vic.	Pts	Pos
1	AGOPIAN Hovanness (72,30)	3k	QC/Ararat	XX	10	10	2	20	1
2	KOSTENKO Borys (72,80)	3k	QC/Ippon		XX		0	0	3
3	FECTEAU Guillaume (70,10)	3k	QC/To Haku Kan		10	XX	1	10	2

## Matches

Match	Blanc			Bleu	Résultat	Temps	Code
D-19	<b>AGOPIAN Hovanness</b>	1	2	KOSTENKO Borys	10 - 0	1:02	IPO
D-31	<b>AGOPIAN Hovanness</b>	1	3	FECTEAU Guillaume	10 - 0	0:55	IPO
D-43	KOSTENKO Borys	2	3	<b>FECTEAU Guillaume</b>	0 - 10	3:09	WIP

## Résultats

Pos	Nom
1	AGOPIAN Hovanness, QC/Ararat
2	FECTEAU Guillaume, QC/To Haku Kan

# U21SENM -04

## Compétiteurs

#	Nom	Grade	Club	1	2	3	Vic.	Pts	Pos
1	LAFHAMME Thomas (72,80)	3k	QC/Rouyn-Noranda	XX	10	10	2	20	1
2	GAMACHE Samuel (72,90)	3k	QC/Judo Monde		XX	10	1	10	2
3	ALAZZOUZI Adam Ryan (73,30)	3k	QC/Metropolitain			XX	0	0	3

## Matches

Match	Blanc			Bleu	Résultat	Temps	Code
C-31	LAFHAMME Thomas	1	2	GAMACHE Samuel	10 - 0	0:06	IPO
C-43	LAFHAMME Thomas	1	3	ALAZZOUZI Adam Ryan	10 - 0	0:24	WIP
C-53	GAMACHE Samuel	2	3	ALAZZOUZI Adam Ryan	10 - 0	0:09	IPO

## Résultats

Pos	Nom
1	LAFHAMME Thomas, QC/Rouyn-Noranda
2	GAMACHE Samuel, QC/Judo Monde



# U21SENM -05

## Compétiteurs

#	Nom	Grade	Club	1	2	3	4	5	Vic.	Pts	Pos
1	ABDELTIF Mostefa Camil (89)	3k	QC/CJCSHP	XX	10	10		10	3	30	2
2	NAHAYO Allen (94,70)	3k	QC/Budokai (QC)		XX				0	0	5
3	ST-LAURENT Jean - Francois	3k	QC/Tritton		10	XX	10	10	3	30	3
4	BUREAU-LAPOINTE Thomas (88)	3k	QC/Univestrie/Donini	10	10		XX	10	3	30	1
5	MICHAUD Samuel (87,60)	3k	QC/Baie-Comeau		10			XX	1	10	4

## Matches

Match	Blanc			Bleu	Résultat	Temps	Code
C-16	BUREAU-LAPOINTE Thomas	4	5	MICHAUD Samuel	10 - 0	1:26	IPO
C-17	ABDELTIF Mostefa Camil	1	2	NAHAYO Allen	10 - 0	0:33	IPO
C-21	ST-LAURENT Jean - Francois	3	4	BUREAU-LAPOINTE Thomas	10 - 0	1:59	IPO
C-22	ABDELTIF Mostefa Camil	1	5	MICHAUD Samuel	10 - 0	1:05	WIP
C-27	NAHAYO Allen	2	3	ST-LAURENT Jean - Francois	0 - 10	0:31	IPO
C-28	ABDELTIF Mostefa Camil	1	4	BUREAU-LAPOINTE Thomas	0 - 10	0:10	IPO
C-37	ST-LAURENT Jean - Francois	3	5	MICHAUD Samuel	10 - 0	2:30	IPO
C-38	NAHAYO Allen	2	4	BUREAU-LAPOINTE Thomas	0 - 10	0:16	IPO
C-49	ABDELTIF Mostefa Camil	1	3	ST-LAURENT Jean - Francois	10 - 0	1:26	WIP
C-50	NAHAYO Allen	2	5	MICHAUD Samuel	0 - 10	0:48	WIP

## Résultats

Pos	Nom
1	BUREAU-LAPOINTE Thomas, QC/Univestrie/Donini
1	ABDELTIF Mostefa Camil, QC/CJCSHP
1	ST-LAURENT Jean - Francois, QC/Tritton
2	MICHAUD Samuel, QC/Baie-Comeau

# U21SENM -08

## Compétiteurs

#	Nom	Grade	Club	1	2	3	4	Vic.	Pts	Pos
1	ROBERGE Alexis (71,60)	5k	QC/CMR Saint-Jean	XX				0	0	4
2	LÉTOURNEAU Charles-Olivier	4k	QC/CMR Saint-Jean	10	XX		10	2	20	2
3	VUKOVIC Djurica (64,60)	4k	QC/Shidokan	10	10	XX		2	20	3
4	ELIBERT Anthony (70,70)	5k	QC/Bushidokan	10		10	XX	2	20	1

## Matches

Match	Blanc			Bleu	Résultat	Temps	Code
A-35	ROBERGE Alexis	1	2	LÉTOURNEAU Charles-Olivier	0 - 10	1:27	WIP
A-36	VUKOVIC Djurica	3	4	ELIBERT Anthony	0 - 10	1:47	IPO
A-46	ROBERGE Alexis	1	3	VUKOVIC Djurica	0 - 10	0:10	IPO
A-47	LÉTOURNEAU Charles-Olivier	2	4	ELIBERT Anthony	10 - 0	1:56	IPO
A-55	ROBERGE Alexis	1	4	ELIBERT Anthony	0 - 10	1:30	IPO
A-56	LÉTOURNEAU Charles-Olivier	2	3	VUKOVIC Djurica	0 - 10	3:27	HAN

## Résultats

Pos	Nom
1	ELIBERT Anthony, QC/Bushidokan
1	LÉTOURNEAU Charles-Olivier, QC/CMR Saint-Jean
1	VUKOVIC Djurica, QC/Shidokan

# U21SENM -09

## Compétiteurs

#	Nom	Grade	Club	1	2	3	Vic.	Pts	Pos
1	FERREIRA-LEAO Guilherme (7)	4k	QC/Judo Monde	XX		10	1	10	1
2	PAYEUR Jean-Christophe (78)	4k	QC/Budokai (QC)	10	XX		1	10	3
3	DAVE Soham (72,90)	4k	ON/Ottawa		10	XX	1	10	2

## Matches

Match	Blanc		Bleu	Résultat	Temps	Code	
C-34	FERREIRA-LEAO Guilherme	1	2	PAYEUR Jean-Christophe	0 - 10	1:05	WIP
C-46	FERREIRA-LEAO Guilherme	1	3	DAVE Soham	10 - 0	0:06	IPO
C-56	PAYEUR Jean-Christophe	2	3	DAVE Soham	0 - 10	0:14	IPO

## Résultats

Pos	Nom
1	FERREIRA-LEAO Guilherme, QC/Judo Monde
1	DAVE Soham, ON/Ottawa
1	PAYEUR Jean-Christophe, QC/Budokai (QC)

# U21SENM -100kg 2k+

## Compétiteurs

#	Nom	Grade	Club	1	2	3	4	Vic.	Pts	Pos
1	CHELFI Kevin (97,90)	1k	QC/Verdun	XX		10	10	2	20	2
2	MADUMBA George (98,30)	1D	QC/Tritton	10	XX	10	10	3	30	1
3	KHALFON Eden (94,20)	1k	Taifu			XX		0	0	4
4	CIUPE Alex Jr (96,70)	1k	QC/Shidokan			10	XX	1	10	3

## Matches

Match	Blanc			Bleu	Résultat	Temps	Code
B-40	CHELFI Kevin	1	2	MADUMBA George	0 - 10	1:24	IPO
B-41	KHALFON Eden	3	4	CIUPE Alex Jr	0 - 10	0:19	IPO
B-50	CHELFI Kevin	1	3	KHALFON Eden	10 - 0	0:55	IPO
B-51	MADUMBA George	2	4	CIUPE Alex Jr	10 - 0	0:47	IPO
B-58	CHELFI Kevin	1	4	CIUPE Alex Jr	10 - 0	1:35	IPO
B-59	MADUMBA George	2	3	KHALFON Eden	10 - 0	2:01	IPO

## Résultats

Pos	Nom
1	MADUMBA George, QC/Tritton
2	CHELFI Kevin, QC/Verdun
3	CIUPE Alex Jr, QC/Shidokan

# U21SENM -60kg 2k+

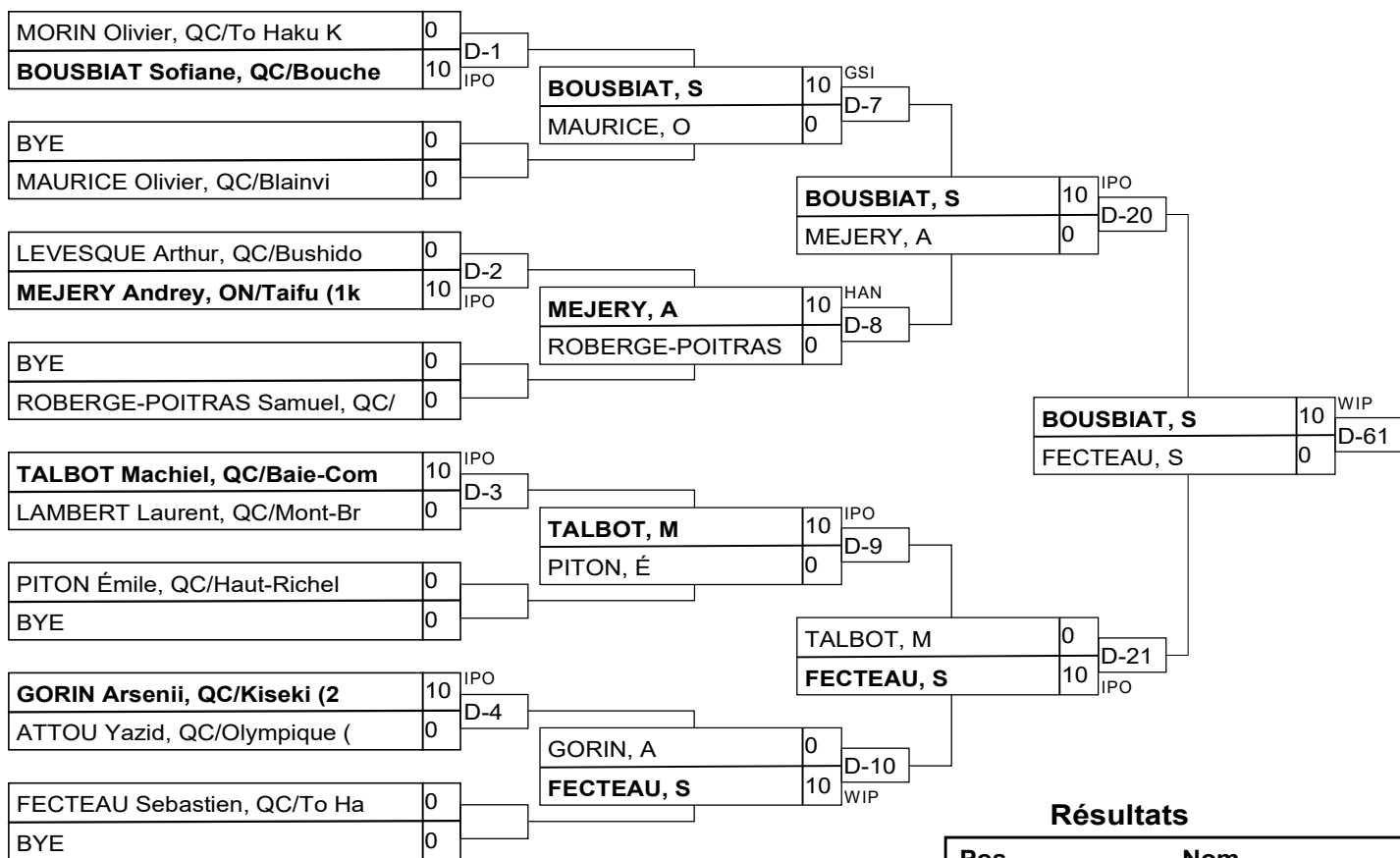

## Résultats

Pos	Nom
1	BOUSBIAT Sofiane, QC/Bou
2	FECTEAU Sebastien, QC/To
3	MEJERY Andrey, ON/Taifu
3	TALBOT Machiel, QC/Baie-

# U21SENM -66kg 2k+

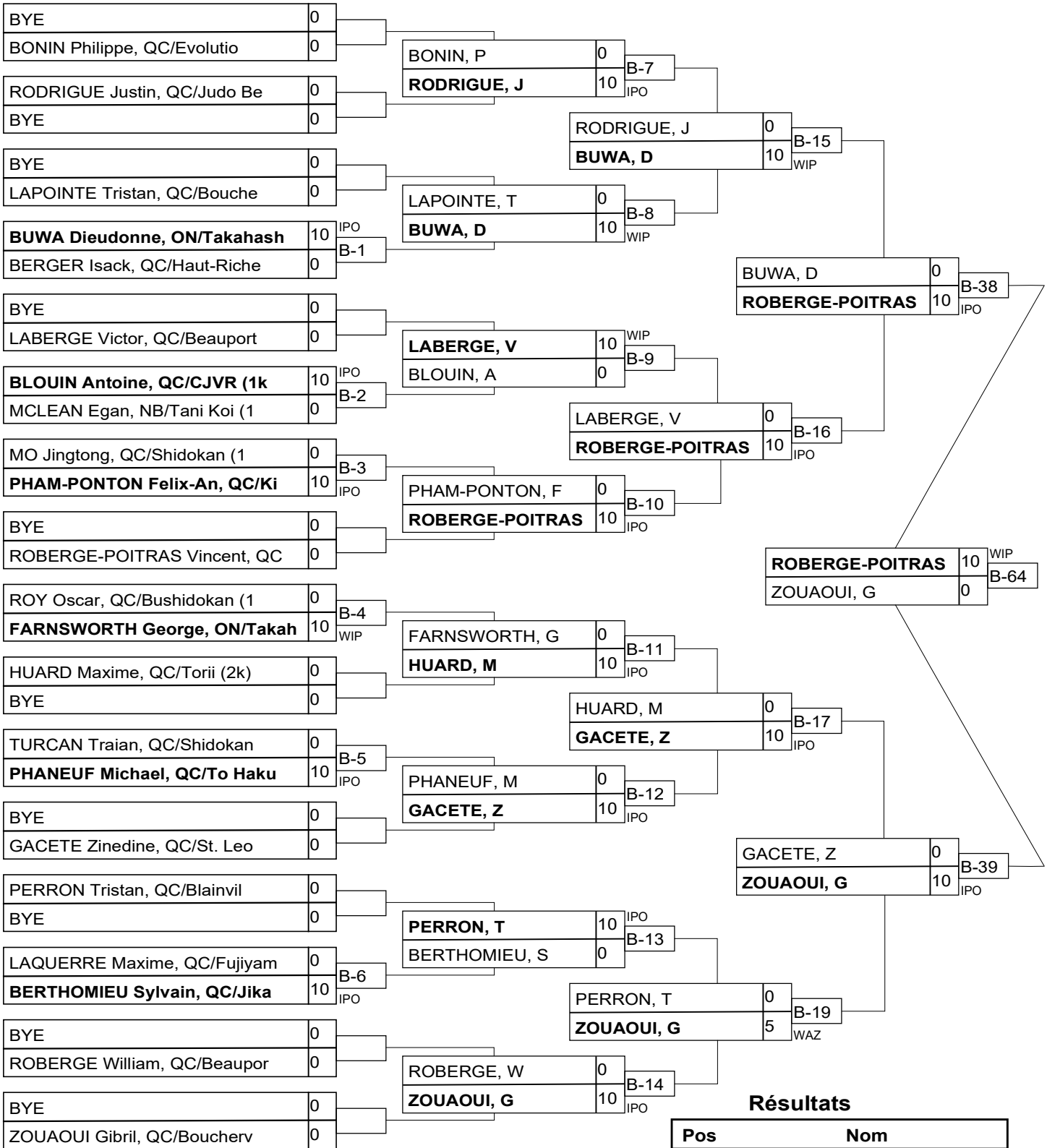

## Résultats

Pos	Nom
1	ROBERGE-POITRAS Vincent,
2	ZOUAOUI Gibril, QC/Bouch
3	PERRON Tristan, QC/Blain
3	TURCAN Traian, QC/Shidok

# U21SENM -66kg 2k+

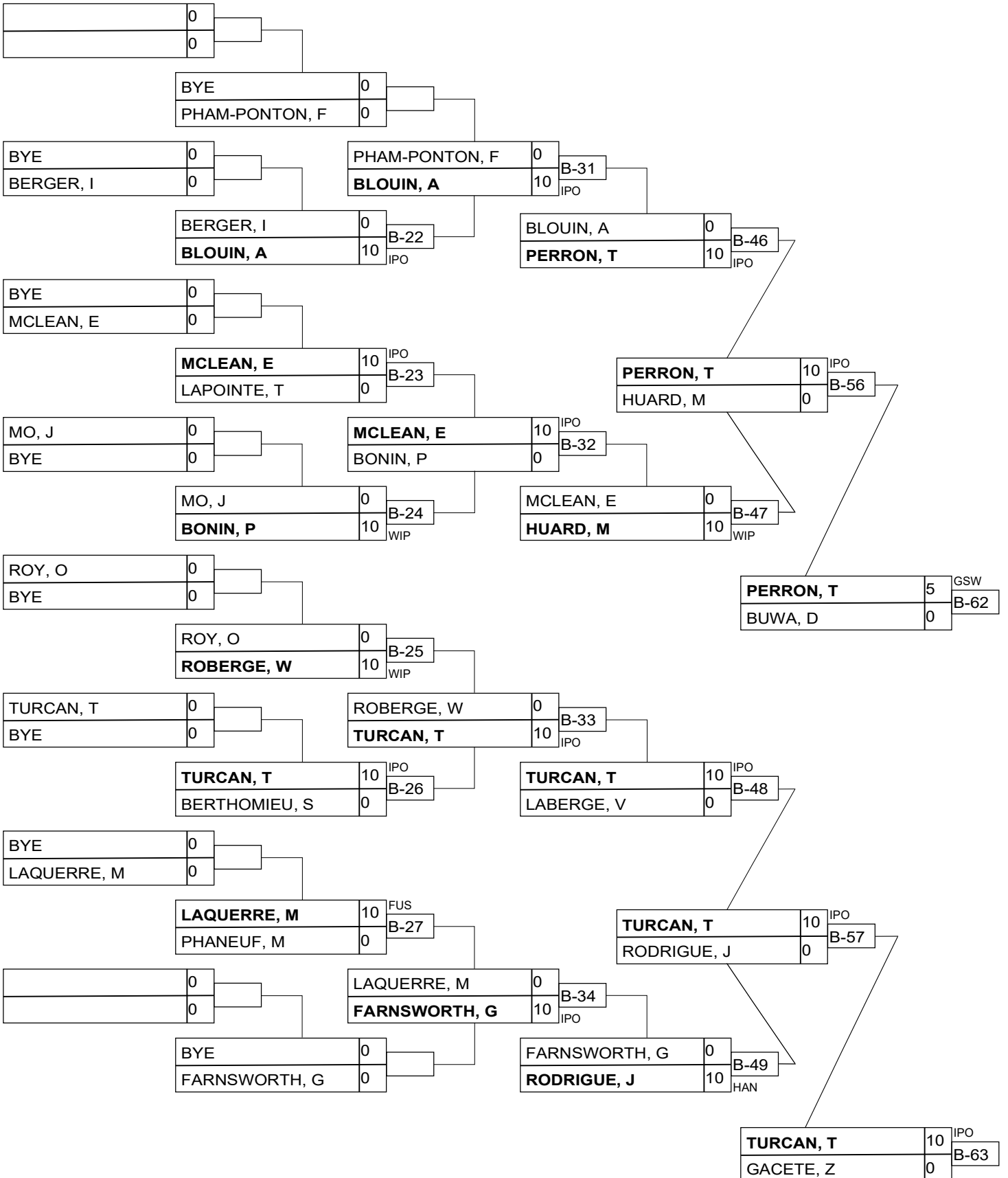

# U21SENM -73kg 2k+

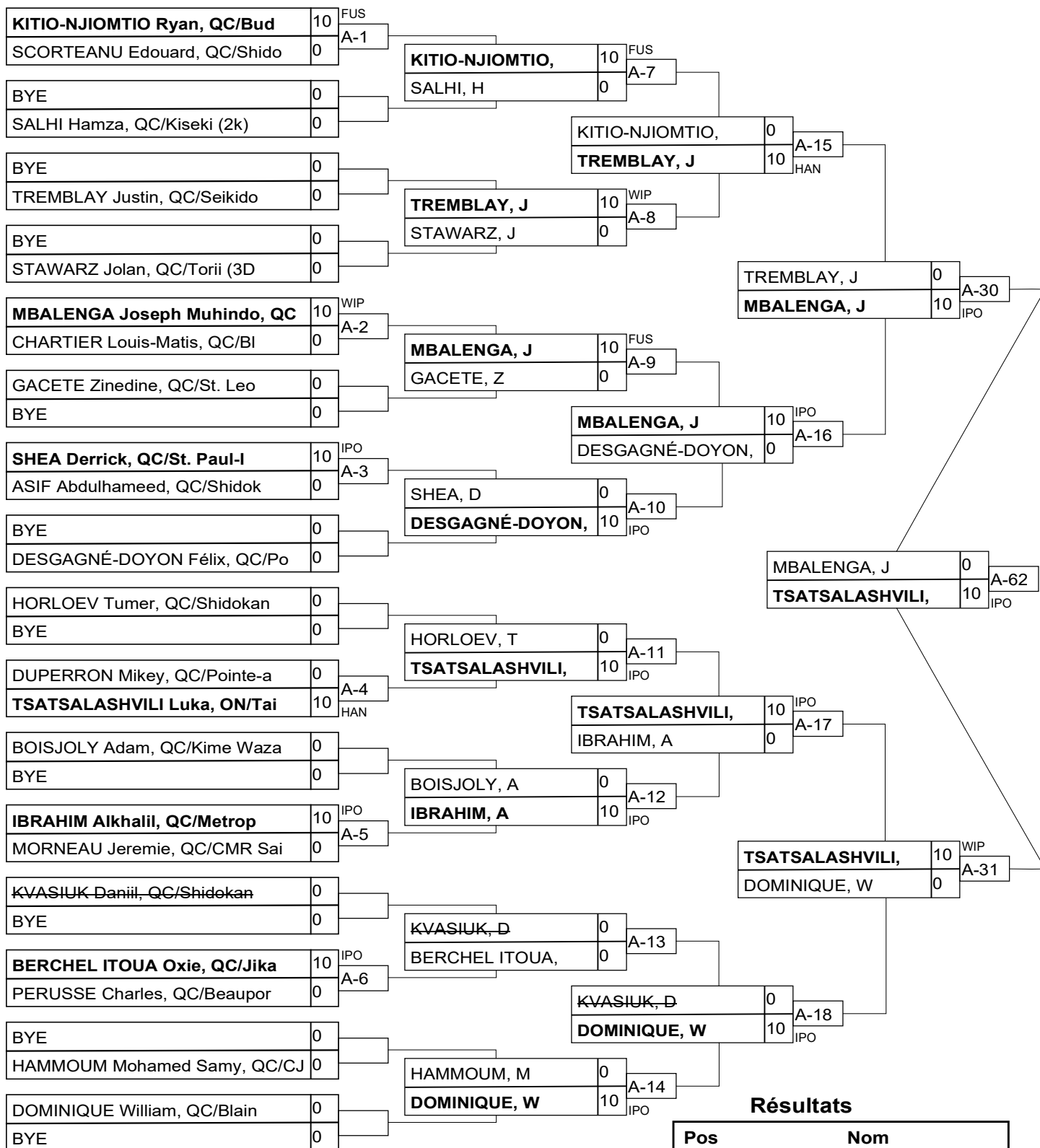

## Résultats

Pos	Nom
1	TSATSALASHVILI Luka, ON/
2	MBALENGA Joseph Muhindo, QC
3	CHARTIER Louis-Matis, QC
3	DOMINIQUE William, QC/BI



# U21SENM -73kg 2k+

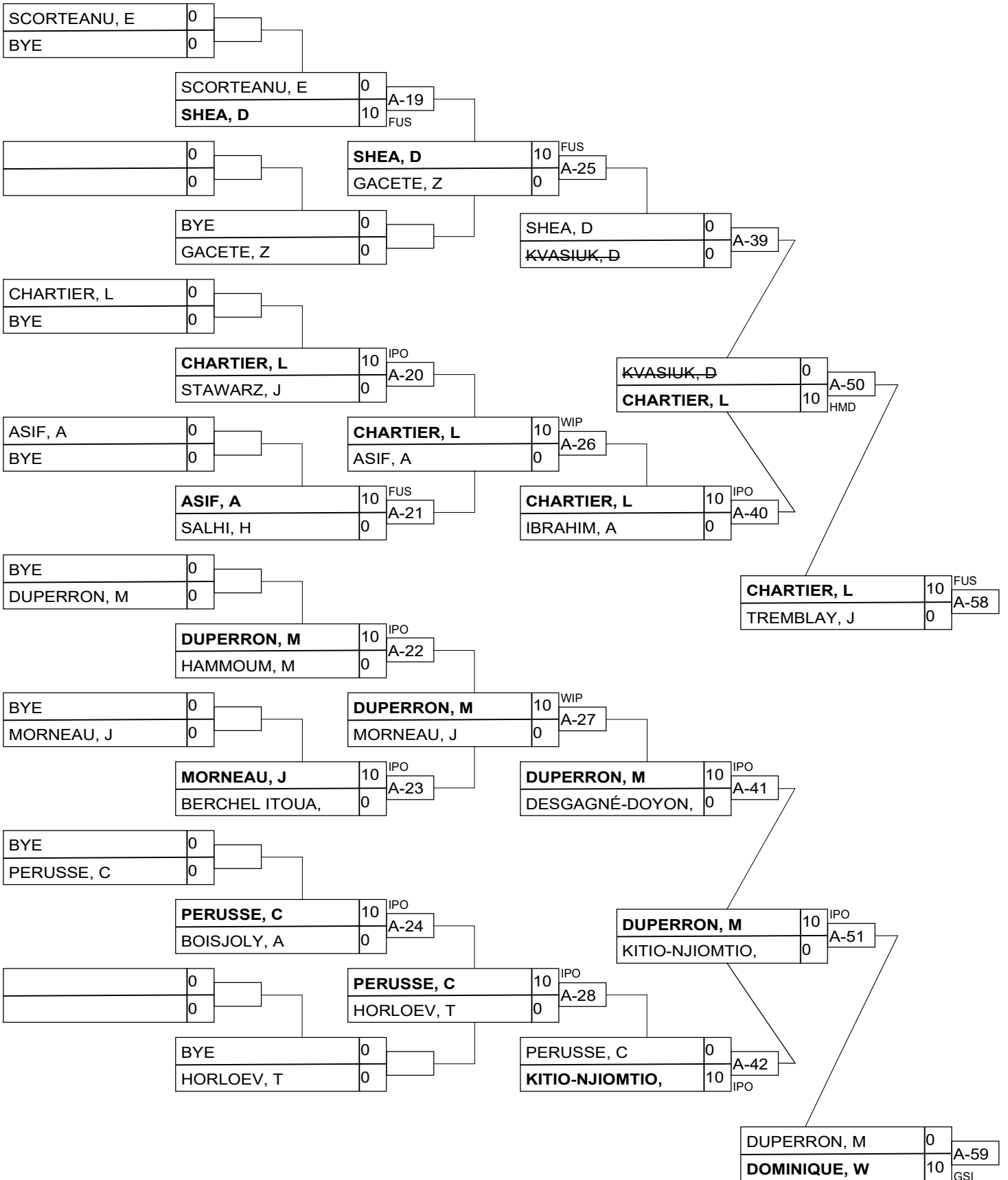

# U21SENM -81kg 2k+

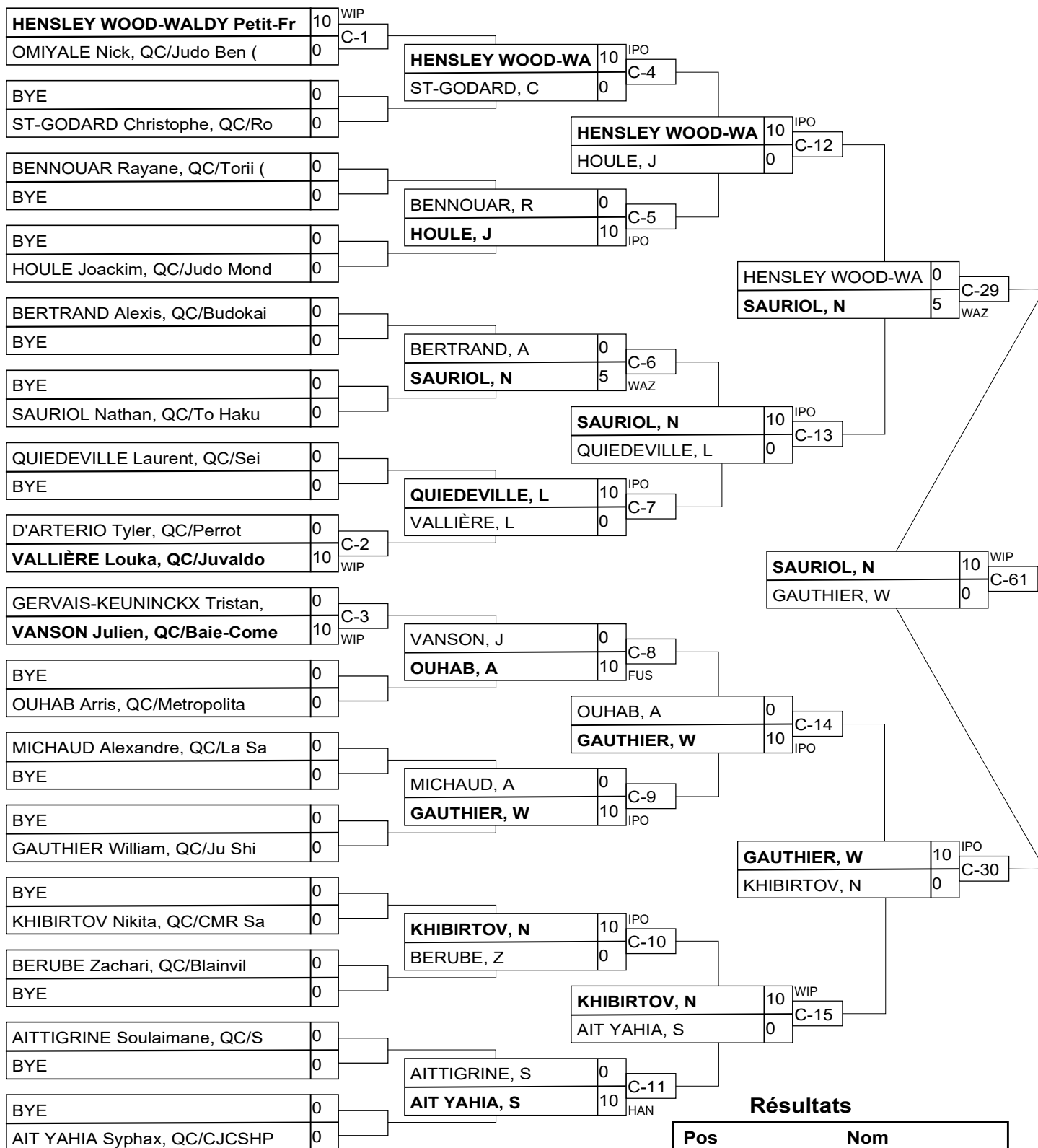

## Résultats

Pos	Nom
1	SAURIOL Nathan, QC/To Ha
2	GAUTHIER William, QC/Ju
3	ST-GODARD Christophe, QC
3	HOULE Joackim, QC/Judo M

# U21SENM -81kg 2k+

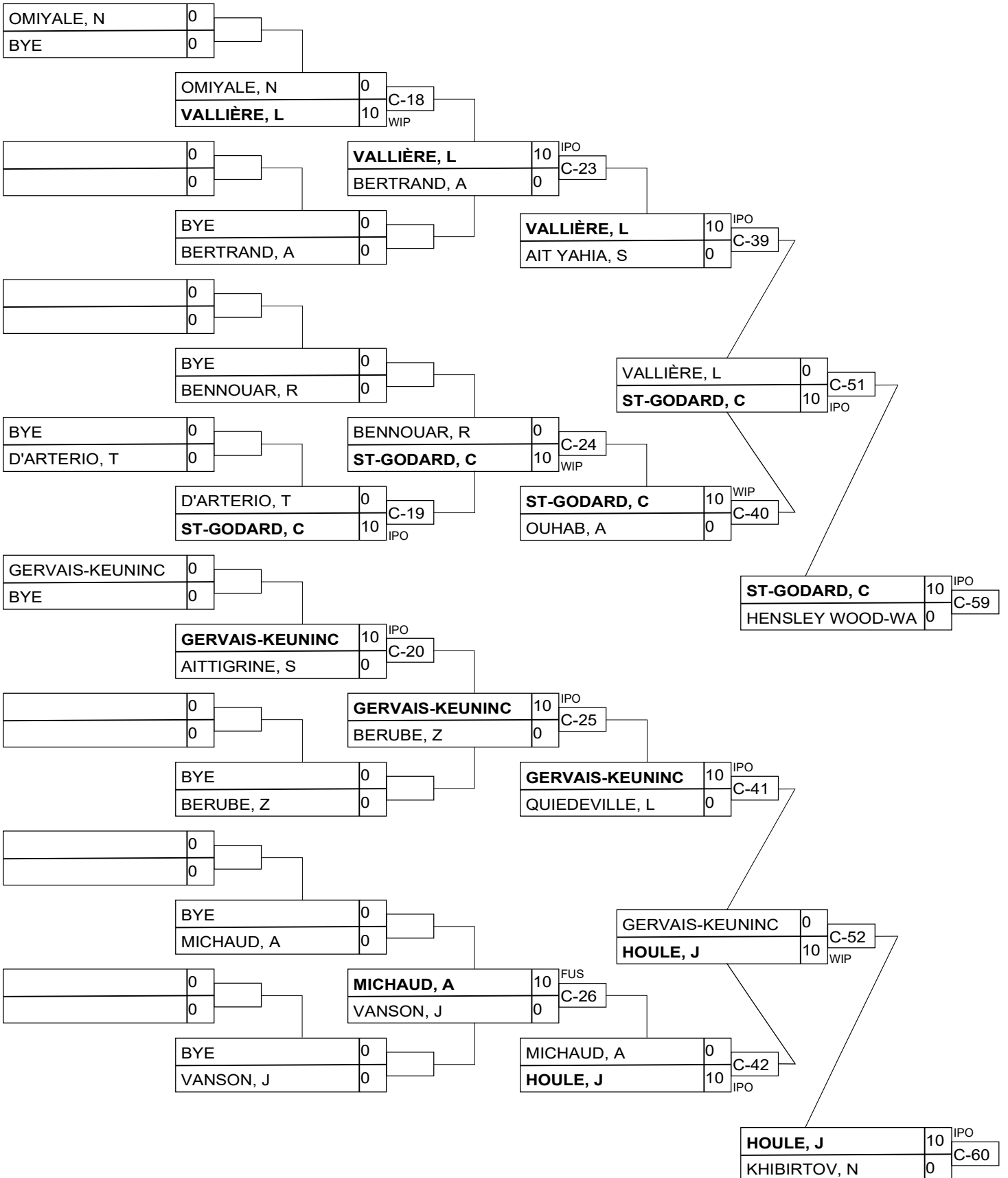

# U21SENM -90kg 2k+

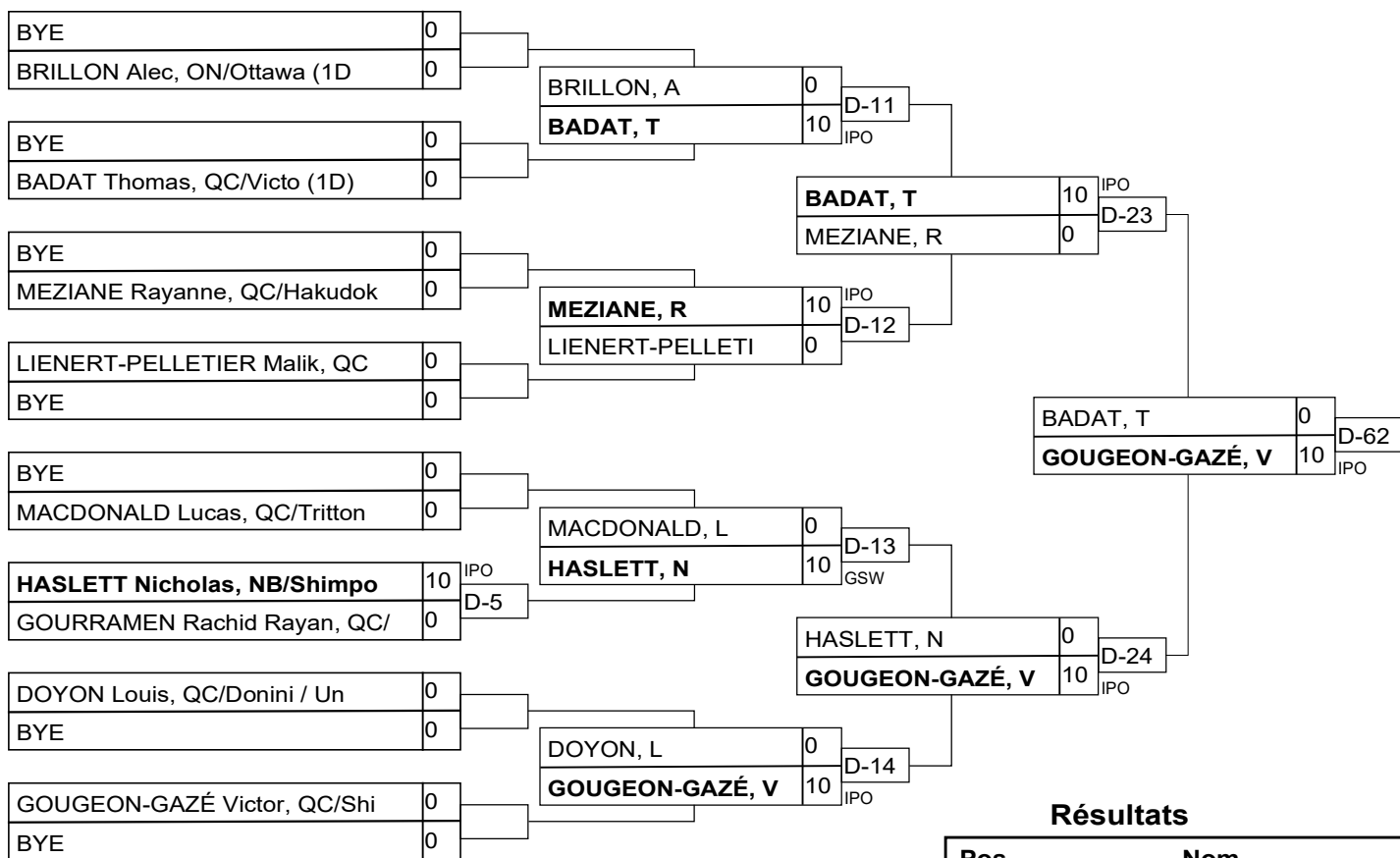

## Résultats

Pos	Nom
1	GOUGEON-GAZÉ Victor, QC/
2	BADAT Thomas, QC/Victo (
3	MEZIANE Rayanne, QC/Haku
3	BRILLON Alec, ON/Ottawa

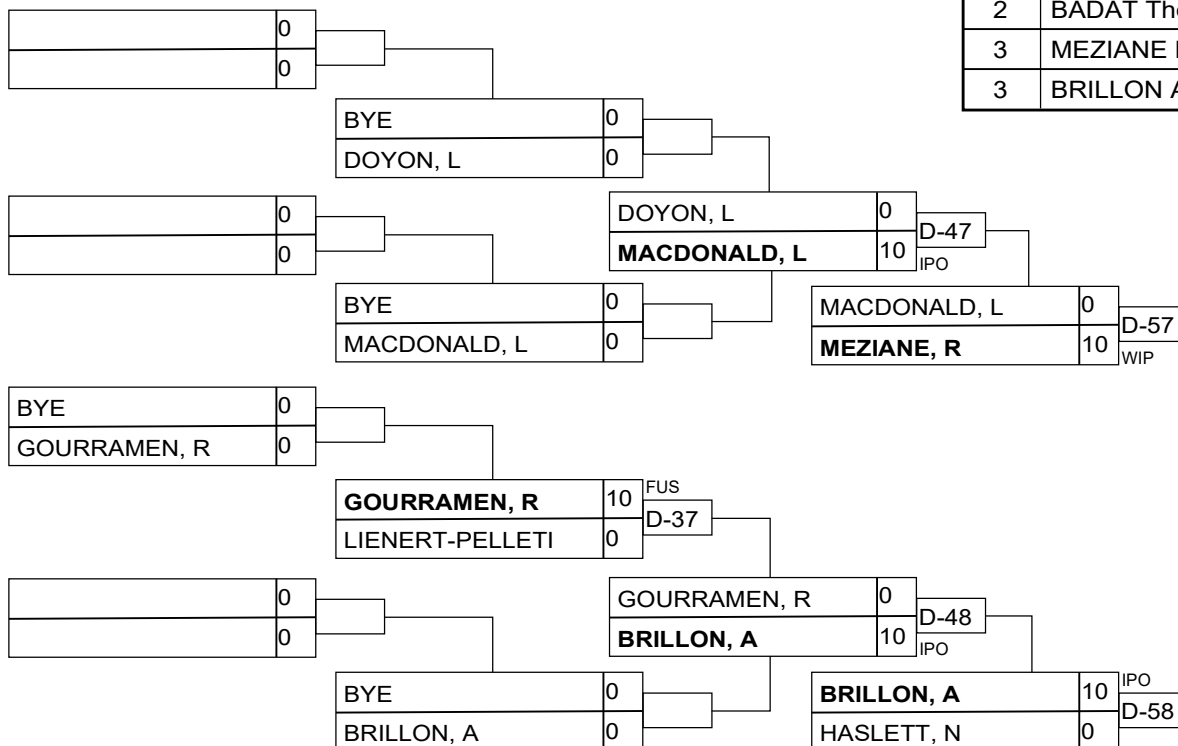

# U21SENM 100kg 2k+

## Compétiteurs

#	Nom	Grade	Club	1	2	3	4	5	Vic.	Pts	Pos
1	GIMENEZ COMAS Agustin (116)	1k	QC/Shidokan	XX	10				1	10	4
2	BÉLAL Rayan (143,80)	1k	QC/Olympique		XX				0	0	5
3	KHAVERI Sajjad (126,10)	1k	QC/Univestrie/Donini	10	10	XX			2	20	3
4	ARENCIBIA Leo (116,60)	1D	QC/Shidokan	10	10	10	XX		3	30	2
5	CALLEJA Matias Ramon (112,	1k	QC/Shidokan	10	10	10	10	XX	4	40	1

## Matches

Match	Blanc			Bleu	Résultat	Temps	Code
B-20	ARENCIBIA Leo	4	5	CALLEJA Matias Ramon	0 - 10	3:08	HAN
B-21	GIMENEZ COMAS Agustin	1	2	BÉLAL Rayan	10 - 0	0:18	IPO
B-29	KHAVERI Sajjad	3	4	ARENCIBIA Leo	0 - 10	2:23	IPO
B-30	GIMENEZ COMAS Agustin	1	5	CALLEJA Matias Ramon	0 - 10	1:47	IPO
B-35	BÉLAL Rayan	2	3	KHAVERI Sajjad	0 - 10	0:00	FUS
B-36	GIMENEZ COMAS Agustin	1	4	ARENCIBIA Leo	0 - 10	0:06	IPO
B-44	KHAVERI Sajjad	3	5	CALLEJA Matias Ramon	0 - 10	3:15	HAN
B-45	BÉLAL Rayan	2	4	ARENCIBIA Leo	0 - 10	0:00	FUS
B-54	GIMENEZ COMAS Agustin	1	3	KHAVERI Sajjad	0 - 10	0:29	IPO
B-55	BÉLAL Rayan	2	5	CALLEJA Matias Ramon	0 - 10	0:00	FUS

## Résultats

Pos	Nom
1	CALLEJA Matias Ramon, QC/Shidokan
2	ARENCIBIA Leo, QC/Shidokan
3	KHAVERI Sajjad, QC/Univestrie/Donini
4	GIMENEZ COMAS Agustin, QC/Shidokan